

Deliverable	D3.2 Report on radial jet-drilling (RJD) stimulation technology
Work package	WP3 State-of-the-Art
Type	R (document, report)
Dissemination level	PU (public)
Due date	October 31st 2016
Actual submission date	October 31st 2016
Lead author (beneficiary)	Guido Blöcher (GFZ)
Contributors	Guido Blöcher, Elisabeth Peters, Thomas Reinsch, Sigitas Petrauskas, Robertas Valickas, Sidney van den Berg
Change History	





Version 10/31/2016	Project SURE - Grant-Number 654662	page 2 / 55
--------------------	------------------------------------	-------------

Contents

1	Executive Summary	5
2	Introduction	6
3	Development of Jetting Technology for Drilling	12
3.1	Rock Penetration	12
3.2	Pulsed Water Jets	16
3.3	Abrasive Water Jets	17
3.4	Cutting Rocks	19
3.5	Perforation & Hydraulic Stimulation	21
3.6	Jet Assisted Drilling	23
3.7	Horizontal Radial Drilling and Ultrashort-Radius Radial System (URRS)	29
4	Radial Water Jet Drilling	34
4.1	Development of RJD technology	34
4.2	Numerical Simulation Related to Radial Water Jet Drilling	40
4.3	State of the Art	42
4.4	Economics	43
4.5	Environmental Impact	44
4.6	Site Application - Klaipeda	45
4.6.1	Background	45
4.6.2	RJD Application	46
4.6.3	RJD Results	46
4.6.4	Discussion	47
5	References	48



Nomenclature

lower case character

k_h Vertical Permeability

k_v Horizontal Permeability

p Pressure

s Depth of Penetration

t Time

v_0 Impact Velocity

upper case character

\dot{V} Flow Rate

BHA Bottom Hole Assembly

CFD Computational Fluid Dynamics

CT Computer Tomography

EGS Enhanced Geothermal Systems

EOR Enhanced Oil Recovery

FEM Finite Element Method

FSB Flexible Sand Barriers

ID Inner Diameter

MSE Mechanical Specific Energy

OD Outer Diameter

PDC Polycrystalline Diamond Compact

PDM Positive Displacement Motor

QRS Quick Radial System

RAG Rohöl-Aufsuchungs AG

RJD Radial Water Jet Drilling

ROC Radius of Curvature



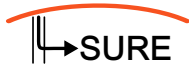

Report on Deliverable

Version 10/31/2016	Project SURE - Grant-Number 654662	page 4 / 55
--------------------	------------------------------------	-------------

ROP Rate of Penetration

RPS Remotely Piloted System

SEM Scanning Electron Microscope

SPH Smoothed Particle Hydrodynamics

TCI Tungsten Carbide Insert

TST Tubing String Testing

UHP Ultra-High Pressure

URRS Ultrashort-Radius Radial System

WOB Weight on Bit

WSG Well Services Group



1 Executive Summary

Radial water jet drilling uses the power of a focused fluid jet, which is capable of drilling multiple laterals of about 100 m length out of an existing well and thereby stimulating the well with full control on the operational parameters like initial direction of the lateral, length, fluid pressure etc. In contrast to hydraulic stimulation treatments, this technology can potentially provide a network of enhanced fluid pathways around a geothermal well to intersect with existing high permeable structures like fracture or karst systems within the reservoir, independent of the ambient stress field.

Applying RJD, laterals typically have a diameter ranging from about 25 mm to 50 mm, depending on jetting parameters like pressure and flow rate as well as rock properties. Drilling a single lateral in a cased well requires approximately 12 hours, as the casing has to be penetrated using a coiled tubing operated milling bit before jetting into the formation. In case the target zone is open-hole, jetting a lateral is considerably faster. Compared to conventional hydraulic stimulation treatments with required fluid volumes of more than 1000 m³, only a fraction of this is needed for RJD (≈ 1 m³). In addition, no pressure will be applied to the reservoir, thereby reducing environmental risk as well as the risk of induced seismicity considerably. Although RJD is investigated and applied in the hydrocarbon industry, applications in geothermal wells are very rare. If the technology can be shown to increase the efficiency of a geothermal well, it will provide an interesting alternative to conventional hydraulic stimulation treatments.

RJD shows highest efficiency in terms of performance increase in reservoirs with low permeability (< 10 mD). The most important criteria for the well are the minimum diameter (4 1/2" OD casings) and maximum along hole depth (about 5 km). So far, RJD operations have been performed in wells with an inclination of up to 46°. Technologies, however, have been developed to perform RJD operations even in horizontal well sections.

Depending on the initial production; for tight gas reservoirs the gas production can be improved with a factor 4-7, simulation for geothermal wells suggest a potential performance increase by a factor of up to 3 when 8 laterals of 100 meter are successfully drilled and geological conditions are favourable. Since the potential increase depends on the type of the geothermal reservoir as well as its properties, the improvement factor has to be confirmed by field experiments.

Currently no major hazards to the well have been identified. The main risk associated with a RJD treatment appears to be sand production from the open-hole completion. However since the amount of experience and well-documented cases is limited, not all risks may have been identified at this moment in time.

Major uncertainties in the production estimates are the long-term (>1 year) stability of the jetted laterals and the effect of sub-surface heterogeneity. The jet-ability of typical geothermal reservoir rocks is also not well documented. As the jet-ability strongly depends on physical rock properties and in-situ reservoir conditions, which are significantly different to typical hydrocarbon reservoirs, the feasibility of RJD in different geological settings has to be evaluated. Although, RJD presents a low cost stimulation method with currently no major identified risk to the well nor to the environment, experience with



RJD in the geothermal industry is rare. Field applications are therefore key to evaluate the potential of the RJD stimulation technology for geothermal applications.

2 Introduction

For this report, about 100 scientific publications related to the development of the radial water jet drilling technology were reviewed. Reviewed publications report mainly about laboratory as well as field experiments performed between 1965 and 2016. In addition, theoretical considerations as well as methods for numerical simulation were evaluated. All presented technologies and related advantages and limitations reflect the state of the art at the time of publication. Specific quantities and values presented in individual publications may represent the evolving technology readiness level over the past 50 years. The attempt was made to categorise the primary focus of the individual publications leading to the current state of the art radial water jet drilling technology (Section 4) into individual key technological developments. Identified key technological developments influencing to the current radial water jet drilling are:

- Rock Penetration (Section 3.1)
- Pulsed Water Jets (Section 3.2)
- Abrasive Water Jets (Section 3.3)
- Cutting Rocks (Section 3.4)
- Perforation & hydraulic Stimulation (Section 3.5)
- Jet Assisted Drilling (Section 3.6)
- Ultra short-Radius Radial System (URRS) (Section 3.7)
- Numerical Simulation related to Jetting Technology (Section 4.2)

Based on these developments, the current state of the art for radial water jet drilling is described in section (Section 4.1). In addition an up-to-date technology readiness level based on current industry experience is included.

Although most of the reviewed papers are not solely investigating one of the key technological development chains, they were categorised according to their main benefit to the individual technologies. An overview of the reviewed papers including the applied methods and investigated parameters is provided in Table 1. Furthermore, few of the scientific publications are reviews on their own. For example, Kolle (1998) compared rotary diamond drilling, ultra high pressure water drilling, mechanically assisted water jet drilling and abrasive jet drilling. A topical report on mechanically-assisted jet drilling and system configuration and integration was authored by Kolle and Theimer (2005). This reports further include a review of downhole intensifiers for coiled tubing directional drilling and the evaluation of bottom-hole assemblies for mechanically-assisted jet drilling





Report on Deliverable

Version 10/31/2016	Project SURE - Grant-Number 654662	page 7 / 55
--------------------	------------------------------------	-------------

as well as for high-pressure jet drilling. Another review on jet-assisted drilling is given by Hood et al. (1990b). In their review, Bosworth et al. (1998) raise key issues in multilateral technology like drilling, completion and later re-entering wells with multiple branches to improve productivity while saving time and money. Marbun et al. (2011) performed a review of Ultrashort-Radius Radial Systems (URRS) which are described in detail in Section 3.7. A report on field testing and diagnostics of radial-jet well stimulation for enhanced oil recovery from marginal reserves was authored by Balch (2015). This report includes the drilling technology and field tests, lateral tracking and sensor developing, a related field simulation and the economic evaluation. A more general overview on water jet drilling, radial drilling and abrasive water jet cutting can be found in the German report on "Geotechnical Downhole High Pressure Abrasive Drilling" (Bochum, 2014). From the reviews mentioned above, only the main conclusions for the development of the radial water jet drilling technology were included in this document.



Table 1: Short summary of literature reviewed for jet drilling technology.

reference	method & parameters	research area
	rock penetration	
Farmer and Attewell (1965)	fixed target, fixed sample, impact velocity, flow rate, nozzle diameter	laboratory
Brook and Summers (1969)	inclined jet and rotating target, pressure, stand-off-distance	laboratory
Maurer and Heilhecker (1969)	pulsed water jet, rotating, up to five nozzles, abrasive, nozzle diameter, fluid pressure, rock strength and pulsed water jets	laboratory
Sakaguchi et al. (2003)	water jet excavation, mechanical properties, density and viscosity, stand-off distance	simulation & laboratory
Sakaguchi et al. (2012)	water jet, failure criteria	simulation
Ivakhnenko et al. (2013)	mechanical heterogeneities	laboratory
Bi et al. (2014)	rock breaking efficiency, hole number, lateral orifice diffusion angle, erosion time, jet pressure, stand-off distance, confining pressure	laboratory
Khorshidian et al. (2014)	rate of penetration, confining pressure, jet velocity, crushed cutting material	laboratory
Li (2014)	nozzle design, cavitation, rotating and self-vibrating nozzles	laboratory
Beckham et al. (2015)	acid jetting, velocity, carbonate rocks	laboratory & simulation
Liu et al. (2015)	jet diameter, angle and velocity, and rock strength	simulation
Lu et al. (2015)	failure pattern and mechanism, jet velocity; SEM	laboratory
	pulsed water jet	
Dekhoda (2011)	rock breakage	laboratory
Dongjun et al. (2011)	jet impact pressure, stand-off distance	laboratory
Ni et al. (2011)	pulse velocity, length, frequency and number	simulation & laboratory
Dekhoda and Hood (2013)	pulse length and frequency	laboratory
Dekhoda (2014a,b); Dekhoda and Hood (2014)	pulse length, pulsating frequency	laboratory
Liu et al. (2015)	rate of penetration (ROP), hydraulic pulsed jet generator, mechanical and hydraulic rock properties, stress state	field
Minghui et al. (2016)	mechanical-specific-energy model, ROP	model & laboratory
	abrasive water jet	
Vestavik et al. (1995)	casing window milling, WOB, torque	laboratory
Feng et al. (2011)	nozzle and cutting head design, flow velocity, deformation due to single particle impact	simulation



Table 1 Continued

reference	method & parameters	research area
Gupta (2012)	polymers	laboratory
Liao et al. (2012)	confining pressure, stand-off distance	laboratory
Srikanth and SreenivasaRao (2014)	glass, nozzle diameter, pressure and stand-off distance	laboratory
Chernyshov et al. (2015)	stress state, abrasive jet, improvement efficiency	field
cutting rocks		
Harris and Mellor (1974)	nozzle pressures, traverse speeds, threshold pressure	laboratory
Summers and McGroarty (1982)	structural properties, flaw density and heterogeneity of the rock	laboratory
Hood et al. (1990a)	erosion mechanism of high pressure water jets	laboratory & model
Hagan (1992)	nozzle diameter, water pressure, traversing speed and multiple passes of a water jet	laboratory
Foldyna et al. (2005)	pulsing water jets, mechanical properties, operation pressure, stand-off distance	laboratory
Ozcelik and Engin. (2012)	abrasive water jet, traverse velocity, pump pressure, cutting depth	laboratory
perforation		
McDaniel and Willett (2002)	stimulation in horizontal completions without cemented casing, hydrojet-fracing-acidizing	field
Schultz et al. (2007)	treatment pressure, rates, fracture gradient, isip	field
Solares et al. (2009)	penetration rate, tool design, rates and pressures	field
Freyer and Shaoul (2011)	multilaterals, environment, productivity, costs	simulation
McAfee et al. (2014)	abrasive water jet, pressure hose, helix system	patent
jet assisted drilling		
Maurer et al. (1973)	high pressure roller bits, threshold nozzle pressure	laboratory
Dely (1977)	drilling vertical wells with high pressure roller bits, improved cleaning, pressure differential into the formation	field
Pols (1977a,b)	considering impermeable rocks (isotropic and laminated), bit pressure drop, density of the drilling mud	laboratory
Hood et al. (1990b)	rock breaking, bit cooling	review
Kolle et al. (1991)	kerfing and cleaning, operating pressure, formation shale content	field & laboratory
Veenhuizen et al. (1997)	pressure, mud weight, and placement of the ultra-high pressure nozzle	laboratory & field
Kolle (1998, 1999)	specific energy parameter	review
Maurer (2002)	coiled-tubing high-pressure jet drilling system, high-pressure slim-hole motor, high-pressure ct systems, flow systems	laboratory



Table 1 Continued

reference	method & parameters	research area
Kolle and Theimer (2005)	mechanically-assisted jet drilling, permeability, bottomhole assembly, downhole intensifier, microhole motors and steering tools and others	review
Kolle et al. (2008)	rotary jet drilling, threshold pressure, permeability, intensifier	field
Kolle (2009)	rop, weight on bit, multilaterals for EGS	laboratory
Lu et al. (2013)	rock breaking technique with abrasive water jet, drilling depth, thrust force and torque	laboratory
Maniam et al. (2014)	bit size, jet-in procedure, jetting speed, bit extension, assembly type, flow rate, formation and survey procedures	review
horizontal radial drilling and ultrashort-radius radial system (URRS)		
Dickinson and Dickinson (1985)	horizontal radials for shallow heavy oil reservoirs, pulling and pushing forces, whipstock, determine trajectories	field
Dickinson et al. (1989)	multiple ultrashort radius radials at the same or multiple levels, reservoir thickness, horizontal and vertical permeability, oil properties, pressure field and thermal processes	field
Dickinson et al. (1990)	URRS and remotely piloted system, data acquisition, analysis and control while drilling	field & laboratory
Toma et al. (1991)	long and ultrashort turning radius of horizontal wells, permeability, skin factors, heterogeneous, immobile oil reservoirs	field
Dickinson et al. (1992a)	URRS and Quick Radial System (QRS), near wellbore damage, reservoir heterogeneity and $\frac{k_w}{k_h}$ ratio	field
Dickinson et al. (1992b)	URRS for Enhanced Oil Recovery (EOR), water coning, natural fracturing, hard-soft inclusion, shale partition, faulting, and other reservoir heterogeneities	field
Dickinson et al. (1993)	URRS, skin factor and completion	field
Bosworth et al. (1998)	multilateral technology, configuration, classification, drilling, management	review
Li et al. (2000)	URRS, underreaming technique, whipstock, completion	field
Guo et al. (2009)	URRS, jet-bit, flow rate, the angle of backward nozzle, and hole diameter	laboratory
Marbun et al. (2011)	URRS, reservoir thickness, permeability, oil properties, thermal processes	review
Dongjun et al. (2012)	URRS, tubing diameter, tubing length, pump delivery and fluid dynamic viscosity	calculation



Table 1 Continued

reference	method & parameters	research area
	radial water jet drilling	
Buset et al. (2001)	reservoir permeability, skin damage, viscosity, nozzle pull force; pi	laboratory & simulation
Bruni et al. (2007)	hydraulic and mechanical reservoir parameter	field
Cirigliano and Talavera Blacutt (2007)	deviated wells	field
Seywald and Marschall (2009)	deflector shoe, centralizer, kevlar hose, jet nozzle	field
Abdel-Ghany et al. (2011)	hydraulic reservoir properties, productivity index	simulation & field
Balch (2011)	fibre optic sensors	review
Elliott (2011)	oil productivity	field
Cinelli and Kamel (2013b,a)	equipment, drilling fluid, advantages and limitations	field
Gang et al. (2013)	self-propelled force, flow rate, forward-reverse flow ratio	field
Huanpeng et al. (2013)	flow rate, pump pressure, forward and backward flow rate ratio, well roughness, mother-well depth, and well diameter	field & simulation
Ragab and Kamel (2013); Ragab (2013)	productivity increase and sustainability	field
Kamel (2014)	limestone jetting with acids, acid fracturing, productivity increase	field
Kohar (2014)	productivity increase, economic feasibility	review & field
Teng et al. (2014)	field test equipment, downhole tools, physical and mechanical parameters	field
Peters et al. (2015)	performance, costs, risks, well and formation requirements	report
Peters (2015)	tight gas reservoirs, low permeability, lateral length	numerical simulation & report
Bin et al. (2016)	pressure-loss, lateral-extending-force, hydraulics of RJD	field & model
	numerical simulation	
Finsterle et al. (2013)	microhole arrays, design for EGS	simulation
Balch (2014)	prediction of lateral efficiency for enhanced oil recovery, reservoir characterisation, history matching	simulation & field
Chi et al. (2015)	maximum drillable length, micro-holes, flow rate, friction, self-propelled multiple jet nozzles	model
Egberts and Peters (2015)	radial water jet drilling, single phase flow, gas and oil production	semi-analytical method
Li et al. (2015)	number, angle, and diameter of the orifices, self-propelled force	model
Zhang et al. (2015)	helix nozzle	model & simulation



3 Development of Jetting Technology for Drilling

Several different key technological developments influenced the radial water jet drilling technology as described in section 4. This section gives an overview about the related technologies as described in section 2.

3.1 Rock Penetration

Rock penetration refers to the process of breaking rocks utilizing the water jetting technology. Water jets can be used to create holes within rock samples during laboratory experiments. The depth of penetration as well as the rate of penetration (ROP) are the primary parameters of investigation. These parameters are related to rock properties as well as the design of the jetting device itself.

First reports on rock penetration by high velocity water jets were published in 1965 (Farmer and Attewell, 1965). In this study, a relation between depth of penetration s , impact velocity v_0 and flow rate \dot{V} was obtained (Figure 1). Furthermore, the mechanical properties of the target material are related to the depth of penetration s for a static nozzle. For impact velocities above 300 m/s, a constant relationship between s and v_0 could be proven experimentally. For impact velocities less than 500 m/s, the average rate of penetration s/t was related to the nozzle diameter. Maximum penetration for soft rocks was reached for nozzle diameters d smaller than 3 mm. For hard rocks, even a smaller nozzle diameter seems to be more efficient.

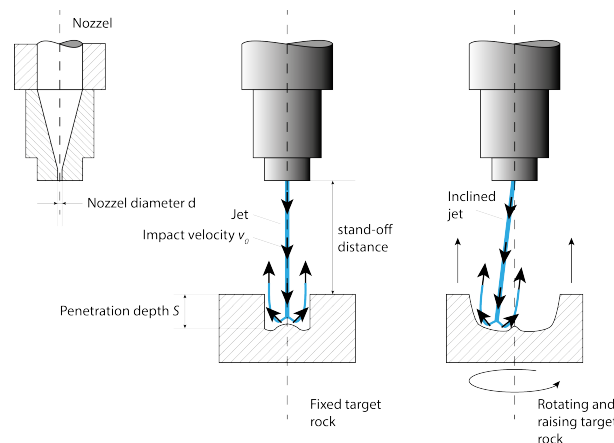

Figure 1: Jet nozzle (left), symmetrical flow in a crater (middle) and hole produced by inclined jet and rotating target (right).

Brook and Summers (1969) investigated the relation of pressure, stand-off distance and time on the penetration of sandstone by a focused water jet. The investigated nozzle diameter d was 0.84 mm (Figure 1). Pressures up to 62 MPa, stand-of-distances up to 50.8 mm and times from 0.5 to 30 s were analysed. During jetting, the impacting fluid has to overcome the resistance of the fluid escaping the impact crater. To increase jetting



Version 10/31/2016	Project SURE - Grant-Number 654662	page 13 / 55
--------------------	------------------------------------	--------------

efficiency, the effects of friction reducer, interrupting the water jet as well rotating sample were investigated experimentally. The initial rate of penetration is in the order of 2 m/s. After one second with continued jetting and static target, however, the rate of penetration falls to 1×10^{-4} m/s. Intermittent jetting or rotating the sample increases the rate of penetration to 1×10^{-3} and 5×10^{-3} m/s, respectively. By simultaneously inclining the jet, rotating the target rock and rising the target, a large hole of 5 cm diameter and 10 cm deep was excavated in about 15 sec (Figure 1).

Maurer and Heilhecker (1969) showed that water jets can efficiently drill through sedimentary rocks. They reviewed and investigated the effect of abrasives, nozzle diameter, fluid pressure, rock strength and pulsed water jets on the depth as well as the rate of penetration. Their review indicates that the higher the nozzle pressures as well as the lower the rock strength, the higher the rate of penetration. For a high concentration of abrasives, less energy is required to drill through rock samples. With nozzle diameters between 5.08 and 25.4 mm, holes with diameters ranging from 20.32 to 101.6 mm and a depth ranging from 25.4 to 76.2 mm were drilled in 0.02 to 0.2 s. During the experiments, a one- and four nozzle bit in a cannon was used to target 5.5 l water pulses at pressures up to 175 MPa onto rock samples. The results indicate that a threshold water pressure must be exceeded before hydraulic jets drill through rock. For Berea sandstone, rates penetration ranging from 2.4×10^{-2} to 3.1×10^{-2} m/s were determined. In addition, continuous hydraulic jet drilling tests were conducted with rotating two-nozzle and five-nozzle bits. The bit was rotating at 60 rpm.

A numerical simulation of the water jet performance in soft saturated rocks was performed by Sakaguchi et al. (2003). The simulation was performed with a special type of particle method (Smoothed Particle Hydrodynamics) and compared to results of excavation experiments in soft rock saturated with water. For the comparison, a hole was jetted into a Kimachi sandstone (Youngs modulus 7.7 GPa, Poissons ratio 0.2 and unit weight 20 kN/m^3). The effect of a nozzle with a diameter of 1 mm, a driving pressure 30 MPa and a stand-off distance of 5.0 mm was investigated for a period of 60 s. It was found experimentally that the entrance to the borehole in the case of saturated rock was larger than that for dry rock. In agreement with the laboratory experiments, the hole diameter obtained by the simulation remained roughly uniform along the borehole axis.

In a subsequent study, Sakaguchi et al. (2012) a three dimensional numerical simulation of water jet excavation of rock by applying the smoothed particle hydrodynamics (SPH) method was investigated. Again, the results of the numerical simulation were compared to laboratory experiments. For the understanding of the rock excavation process, five types of failure criteria were proposed for the simulation: (1) tensile strain criterion; (2) travelling distance criterion; (3) equivalent strain criterion; (4) stress criterion; (5) Mohr-Coulomb criterion. Comparing numerical and laboratory results, it was concluded that the tensile strain criterion most closely approximated the mechanism of water jet excavation. In addition, both, numerical simulation and experimental results from the laboratory experiments indicate that the excavated volume increased with cutting time.



The borehole is bowl shaped close to the surface with an enlarged opening then narrowing with increasing distance from the surface. Below, it enlarges again with an increase in depth.

Ivakhnenko et al. (2013) investigated the effectiveness of water jetting for rocks with different mechanical properties. The authors used the concept introduced by Teale (1965) to relate the energy of the jet to the volume of excavated rock to determine the specific energy and evaluate the jetting efficiency. Laboratory experiments were used to analyse water jet penetration in different rock types, such as sandstones, carbonates, conglomerates, dolomites and limestones. In addition, variations of mechanical properties in unconsolidated and cemented rocks as well as rock with pores filled with different minerals including clays and quartz were investigated. It was found that the method of penetration differs for differing mechanical heterogeneities of rocks.

In radial drilling technology used for horizontal drilling, generally, multi-jet (multiple numbers of forward jets) bits are used. Bi et al. (2014) investigated the influence of the nozzle design and hydraulic parameters on rock breaking efficiency by laboratory experiments and could show that the jetted hole becomes more circular with increasing numbers of nozzles in the jet bit. An almost circular borehole was jetted with a bit having 9 individual nozzles. Furthermore, under zero confining pressure, an optimum stand-off distance was experimentally found to achieving the largest rock breaking volume and borehole depth. The optimal stand-off distance is 5 to 6 times of the equivalent nozzle diameter. An increase in confining pressure significantly decreases the rock breaking efficiency. An increase of hole number will decrease the rock breaking efficiency under the same equivalent nozzle diameter.

Khorshidian et al. (2014) investigated the influence of a high velocity fluid jet on the rate of penetration of PDC bits under pressurised conditions by laboratory experiments. The ROP of the two investigated PDC bits decreased with increasing confining pressure, caused by rock strengthening as well as an accumulation of crushed cuttings between the bit face and the rock surface. Due to the additional cutting volume between bit and rock surface, the friction of the bit increased, increasing an additional confining pressure component. An appropriate jet flow, however, can significantly increase the ROP. To increase cutting removal, high jet velocities and therefore flow velocities ahead of the bit are desired to achieve cavitation condition. Experimental results indicate an optimal jet flow ahead of the nozzle. A further increase of the jet velocity above this optimum will not result in an increased ROP.

Cavitation was found to significantly increase the ROP during jet drilling experiments. Li (2014) found that the impact pressure produced by bubble bursts is not the primary reason for the strong breaking capability of cavitation. The increased ROP is attributed to the the pressure fluctuation caused by density variation between the gas bubbles and the fluid acting on the rock surface. Cavitation only occurs at vapour pres-



sure, the static pressure at the well bottom, therefore, must be reduced to achieve this condition. Different nozzle designs were tested, e.g. nozzles with high rotational speed as well as self-vibration nozzles. However, required rotational speed could not be achieved in laboratory tests. Only self-vibration nozzles could be shown to achieve cavitation condition. During the process, the generated pressure by self-vibration is superimposed on the ambient pressure condition. Cavitation, therefore may occur but the impact on the rock surface was found to be very small due to the small size of the vapour bubbles.

Another way to increase the ROP is the additions of chemicals, e.g. acid to the jetting fluid. Beckham et al. (2015) investigated the effect of jetting with hydrochloric acid on the carbonate dissolution by laboratory experiments. Jetting velocity and the acid flux were varied in the experimental procedure to analyse the impact of the acid jetting. For acid jetting with jet velocities ranging from 30.5 to 61 m/s, bulb-shaped cavities in the face of the rock were observed. Using CT scans of jetted rock samples, wormholes were observed to be formed starting from these cavities. For low velocity acid jetting, no cavities were created. For pure water, in the absence of acid flux, cavities without wormholes could be observed at high jet velocities. At low jet velocities, no cavities or wormholes were observed.

The efficiency of rock breaking by water jet was investigated based on finite element method (FEM) and smoothed particle hydrodynamics (SPH) by Liu et al. (2015). On the one hand, the impact of jet pressure for varying nozzle diameters and fluid velocities was simulated. On the other hand, the effect of water jet diameter, jet angle and jet velocity on the efficiency of rock breaking was studied. It was observed that most micro-damages formed when the jet angle was 0° , However, an optimal jet angle of about 10° could be identified. In consistency to previous studies, it was found that the rock breaking efficiency increases with the diameter of the jet and its velocity. The effect of an increasing velocity of water jet is most obvious to rocks with a small rock strength, whereas a decreasing strength does not change the cutting width but the cutting depths.

As shown before, high-velocity water jets can cause the erosion of the rock structure. However, the jet velocity itself greatly influences the ROP and the failure pattern of rocks. Lu et al. (2015) conducted a series of experiments with water jet velocities ranging from 157 ± 1 m/s to 774 ± 1 m/s. To understand the damage mechanism for sandstone, Scanning Electron Microscopy (SEM) was used to examine the fracture morphology. Based on the results, different failure mechanisms could be identified. Lu et al. (2015) summarizes: (a) Central broken pit surrounded with a circumferential cracks. The central pit is caused by shear components, whereas, the surrounding cracks are caused by the tensile stress; (b) internal fractures in the shear fracture zone below the broken pit; (c) macro-cracks on the side surface caused by the conical fractures. It was advised for further investigations to take into account the following topics:(a) the jet parameters; (b) the variation of rock material; (c) the dimension of rock samples.



3.2 Pulsed Water Jets

The disadvantage on continuous jet perforation is the pressure build up in front of the nozzle and the related reduced cleaning efficiency. Therefore, pulsed water jets with varying frequency and pulse length are investigated to overcome these limitations. It can be shown that pulsed water jet can increase the rate of penetration in laboratory experiments. But data from field scale experiments are scarce.

Dehkhoda (2011); Dehkhoda and Hood (2013); Dehkhoda (2014a,b); Dehkhoda and Hood (2014) investigated the rock breakage by pulsed water jets. In order to generate a water pulse, a hammer strokes a piston on top of a water-filled chamber. The piston pressurises the water which is then expelled at high velocity through a nozzle. In addition to this specific mechanism, a good summary of types of water jets, water jet pressures, jet parameters on rock breakage and cutting processes is given. Dehkhoda and Hood (2013) describes the impact of pulse length and frequency on the excavation processes. Two pulse lengths (458 mm and 888 mm) and three frequencies (53 Hz, 106 Hz, and 212 Hz) were investigated by laboratory experiments. Two types of rocks, granite and marble, were tested. The results were analysed in terms of specific energy necessary for the excavation. It was found that, based on the rock type, either the pulse length or the pulse frequency plays a dominant role in creating local damage. Directly under the impacted surface, the pulsation frequency was found to be the dominant parameter for creating the failure zone. The propagation of the initiated sub-critical cracks leading to major rock failure is controlled by the pulse length. In addition, with increasing cavity depth, the pulse length required to propagate sub-critical cracks increases as well. In general, the damage increases overall when the jet contained higher amounts of energy.

Based on a multihole nozzle, Dongjun et al. (2011) investigated the rock breaking efficiency improvement by applying pulsed water jets that meet the cavitation conditions. The rock breaking volume is found to be up to 2.35 times higher than that of simple multihole nozzles. For an optimum efficiency, the authors suggest a minimum jet impact pressure of 30 MPa to generate a hole bigger than the nozzle diameter itself and a stand-off distance of 12 mm.

The rock breaking efficiency with pulsed jets was studied with non-linear FEM and dynamic rock damage model by Ni et al. (2011). The results of the numerical simulation were found to be comparable to results from laboratory experiments. The simulation results were compared to experimental results. The effect of velocity and length of the pulse, the frequency and pulse number was investigated. It was shown that volume, depth and diameter of the excavated hole increases with increasing of length and velocity of the pulsed water jet. Increasing the pulse frequency increases the excavating efficiency first but decreases the efficiency above a certain threshold, indicating an optimal frequency range for the process.

Low rates of penetration (ROP) and high drilling cost are two major challenges in



shale gas exploration in China (Liu et al., 2015). The impact of pressure pulsation and local negative pressure effects, pressure distribution and stress state of the rock surface on the ROP was studied and compared to continuous water jets. By means of field experiments, two well intervals ranging from 1147.5 m to 1243.3 m and from 2060.6 m to 2848.8 m depths were investigated. The ROP applying a pulsed pressure jet increased by approximately 27.7% and 105% for the individual sections. During a net drill time of 211 h, the internal structure of the hydraulic pulsed jet generator was not damaged by erosion.

3.3 Abrasive Water Jets

Similar to the pulsed water jet technology, water jets with abrasives are investigated in terms of casing window milling and penetration of rocks. Very small particles are added to the fluid jet which individually remove only small fragments of the rock. Laboratory experiments indicate an increase of the drilling rate above that of conventional tools. In contrast, only few field application exist to validate these experiments.

An application of abrasive water jets was presented by Vestavik et al. (1995). The authors demonstrated a method to mill a window into the casing with abrasive fluid jet in the laboratory. The following conceptual solution for the coiled tubing window milling system is proposed: A cement plug is placed in the casing downhole prior to the window milling operation. A coiled tubing equipped with a motor and a specially designed abrasive jet assisted milling bit enters the well through a production tubing. Downhole, the drill bit is steered using a combination of an orienting and a surveying tool. Abrasives are injected into the drilling fluid at the surface. Downhole, a pressure intensifier is used to enhance the jetting efficiency. The experimental milling assembly was successfully used for milling a 1.4 m long and 0.1 m diameter window in a 177.8 mm steel casing with a wall thickness of 12 mm. A flow rate of 90 l/min, pressure of 300 bar and an abrasive concentration of about 5% by weight was applied. With a maximum WOB of only 4 kN and a rotary speed of 180 rpm a ROP in the range 100 - 150 mm/h was achieved. With the described method, no whipstock was required to exit the casing.

The hydrodynamic characteristics of abrasive waterjet in a cutting head were investigated by numerical simulation (Feng et al., 2011) using new CFD model with smooth particle hydrodynamics (SPH) coupled with finite element method (FEM). The model was applied to determine the optimal focus length, the outlet velocity, as well as the ratio of diameter and the maximum outlet velocity. Furthermore, interaction between the single abrasive particle and a workpiece is simulated and validated. The model can therefore be used to improve the design of the cutting head.

Gupta (2012) investigated the addition of polymers for abrasive water-jetting experiments performed on sandstone, granite and steel. It is well known that water-jet pressure



and depth of cut have a linear relation above a certain threshold pressure. Jet efficiency increases with particle size, but the particle size is limited by nozzle diameter. Optimum particle size should be less than one third of the nozzle diameter. Furthermore, the abrasive flow rate plays a critical role Gupta (2012, and references herein). In this paper it was concluded that effective length of water-jets reduced by a factor of 3 from ambient to submerged conditions. Adding polymers to suspend sand will enhance water-jet cutting effectiveness. For the tested polymers an optimum concentration exists.

Conical water jets, cavitating jets, and abrasive jets were tested (Figure 2) with a maximum nozzle pressure drop of 25.0 MPa and maximum confining pressure of 20.0 MPa to simulate in situ conditions by Liao et al. (2012). From the experiments, the authors observed a close relation between confining pressure, jet impact pressure and the rock-breaking efficiency. It was found that jet impact pressure and excavated volume decrease with increasing confining pressure until a certain threshold where relation flattens with increasing confining pressure. Under constant conditions, self-resonating cavitating nozzles show a higher efficiency than conical nozzles. It was found that the optimal stand-off distance for pure water jets is about 3 to 5 times that of the nozzle outlet diameter. It was concluded that the drop of the impact pressure with increasing confining pressure might be the main reason for a reduced rock-breaking efficiency.

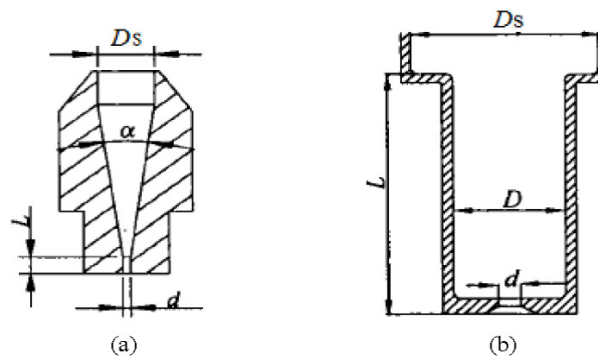

Figure 2: (a) Conical nozzle and (b) cavitating nozzle (Liao et al., 2012).

Drilling of glass with different stand-off distances, pressures and different nozzle diameters using abrasive jet drilling was investigated by Srikanth and SreenivasaRao (2014). Fine abrasive particles (typically ~ 0.025 mm) are accelerated in a gas stream towards the sample surface with jet velocities in the range of 150-300 m/s and pressure from 2 to 10 bars. An optimum performance for Larger Is Better conditions is found at air pressure (8 kg/cm²), stand-off distance (10 mm) and nozzle diameter (4 mm). The influence of the different parameters on the jetting performance was ranked in the following order: nozzle diameter, pressure and stand-off distance. An optimum performance for Smaller Is Better conditions is found at air pressure (6 kg/cm²), stand-off distance (9 mm), and nozzle diameter (3 mm). Here, the influence of the different parameters on the jetting performance was ranked in the following order: nozzle diameter, pressure and stand-off distance.

3.4 Cutting Rocks

This section refers to the potential of cutting rocks by water jets. In contrast to section 3.1, the jet is moved relative to the cutting object. The water jet pressure, velocity, stand-off distance and transverse speed are the major parameters. Mostly laboratory experiments are performed to investigate the potential of cutting rocks. In this section the jetting of laterals or holes are not considered.

The possibility of cutting rocks by water jets was tested by Harris and Mellor (1974). Samples of Berea sandstone, Indiana limestone and Barre granite were tested at nozzle pressures ranging from 6.9 to 413.7 MPa, traverse speeds ranging from 6.1×10^{-4} to 1.68 m/s, and nozzle diameters from 0.2 to 0.38 mm. In contrast to previous studies, the initial results relating penetration to nozzle pressure for sandstone gave no indication of a limiting 'threshold pressure' for cutting. The corresponding data for granite appear to contrast with those for sandstone and limestone, in that they suggest a pressure intercept of approximately 55.2 MPa. The authors correlate the penetration depth s to nozzle pressure p by a polynomial function. For penetration depth against traverse speed a log-log plot could be used to linearise data for a restricted range of values.

While equipment and technological developments have occurred, the understanding of the exact mechanisms of water jet erosion have been less well developed. Therefore, Summers and McGroarty (1982) investigated mechanism and some other parameters controlling the water jet cutting the rock. Until this study, uniaxial compressive strength of the target rock was assumed to be the major parameter of rock erosion resistance. Summers and McGroarty (1982) considered that the structural properties of the rock, and most particularly, the flaw density and heterogeneity of the rock are the dominant parameters. The flaw density is described as the inversely correlated to grain size and the surface energy of the rock.

Hood et al. (1990a) studied erosion mechanism of high pressure water jets. based on the results, the authors proposed a new model to analyse the kerf created by the jet. It was concluded that the jet power indicates the depth of the kerf. In addition, the a model for process understanding of the micromechanics of jet cutting was proposed. The model suggests that a cyclic process of formation and subsequent removal of narrow ledges in the water jet curve is responsible for the erosion.

In comparison to other studies which investigated the combination of mechanical rock cutting tools with water jets (Figure 3), Hagan (1992) investigated the sole use of water jets in cutting rock. The authors used laboratory equipment capable to deliver 4.7 l/min at pressures of up to 380 MPa. The water jet was formed by Sapphire nozzles with a conical outlet and nozzle diameters ranging from 0.15 to 0.36 mm. The rock samples were moved linearly with respect to a stationary water jet at velocities between 50 and



Version 10/31/2016	Project SURE - Grant-Number 654662	page 20 / 55
--------------------	------------------------------------	--------------

300 mm/s. Although rock properties such as compressive strength, fracture toughness, porosity, grain size and surface roughness were considered in the analysis, it was found that the influence of jet and operational variables is much more important for the cutting performance. The authors observed following relations: (1) At low water pressures, slot depth increases very little with nozzle diameter. With increasing pressure, the nozzle diameter tends to become more important. (2) There is evidence of an optimum nozzle diameter. (3) A minimum critical nozzle diameter required to damage the rock exists. (4) Slot depth increases linearly with water pressure. The slope of this curve increases directly with nozzle diameter and inversely with traverse speed. (5) A threshold water pressure exists, which appears to be little affected by nozzle traverse speed. (6) Multiple jet passes tend to increase the slot depth.

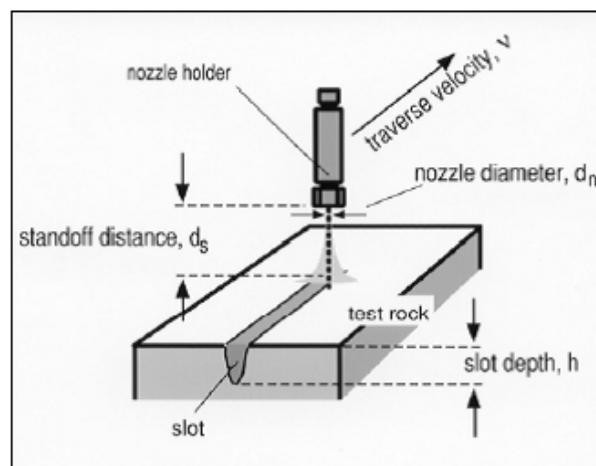

Figure 3: Main parameters in water jet cutting (Hagan, 1992).

Foldyna et al. (2005) investigated as well the cutting performance of water jets. The new approach was to use pulsations instead of continuous pressures in high-speed water jets. Cutting tests were performed at pressures of 30 MPa for basalt, sandstone and granite samples, and 50 MPa for basalt samples only. The nozzle diameter was 1.45 mm, the traversing speed 1 m/min. The stand-off distance was varied from 20 to 60 mm during the tests. An acoustic generator was used to generate pressure pulses at 20 kHz. Compared to a continuous jet, the depth of the cut was increased by a factor of 10 for basalt at 30 MPa, 123 for basalt at 50 MPa, 1.9 for sandstone and 1.6 for granodiorite. It was concluded that pulsing water jets has a good potential to create viable, efficient, and environment friendly technology for stone quarries.

Ozcelik and Engin (2012) develop a cut-ability chart for abrasive water jet cutting. For this purpose abrasive water jet cutting was performed at six different traverse velocities and six different pump pressures at a constant stand-off distance of 5 mm), an abrasive flow rate of 225 g/min and a nozzle diameter of 0.3 mm. Based on the statistical analysis for Usak Green and Beypazari Granite stone sample an optimum working point



for cutting could be identified. Applying the cut-ability charts, it is possible to determine cutting depths for different working conditions.

3.5 Perforation & Hydraulic Stimulation

Penetrating through the near wellbore damage zone has the potential to significantly improve the well performance Elshahawi et al. (2001). In addition to conventional technologies to overcome the near wellbore damage zone by perforating charges or hydraulic stimulation, water jetting technologies of are increasing interest. Abrasive water jets are not only used for milling a window into the casing (e.g. section 3.3) but also to penetrate the near wellbore region (few centimetres to meters). Therefore, the abrasive jetting technology for penetrating the near wellbore region was reviewed and compared to conventional technologies.

A high percentage of horizontal wells drilled in low permeability formations have failed to meet production goals without significant stimulation. McDaniel and Willett (2002) identified major challenges to be discussed in relation to the stimulating horizontal wells: low permeability itself, fracture placement and transverse vs. longitudinal fractures. Furthermore, the requirements for completion in order to allow for stimulating horizontal wells like open hole completion, perforated or slotted liner and blank liners with perforation are discussed. To position the fractures along the well, casing packers, partially cemented liners or cemented casings are used. In addition, the authors present the new technology of "hydrajet fracing". Here, a small cavity is jetted into the formation. After such a fracture initiation, fluid is pumped through the annulus to increase the wellbore pressure and extend the fracture. After re-positioning the tool, this process can be repeated. The fracture distribution therefore can be fully controlled. The presented technology allows for fracture placement in some completions without a cemented liner. The jetting tool is either conveyed by a drill string or CT. All the fluid needed to extend, prop or acidize the fracture is pumped down the tool and out into the jets.

Another well-known application is abrasive perforation on coiled tubing in vertical and horizontal wells. This technology was compared to conventional tubing conveyed perforation by Schultz et al. (2007). The objective of both technologies is to reduce near wellbore friction and therefore allow for a hydraulic fracture treatment at significantly lower pressures, justifying the additional costs for the operation. After explosive perforation a premature sand screen-out can cost more than the abrasive perforation due to cleanouts, re-perforation, lost time and lost production.

The technique of abrasive jetting can be applied in high-pressure and temperature environments with low permeability and high fracture gradient. It was observed that in such an environment, conventional perforating techniques are often not sufficient to breakdown the formation during fracturing. To overcome this limitation, Solares et al. (2009) tested a novel abrasive jetting tool designed to create large diameter, long cavities



in the formation in a field experiment field. The tool consists of an anchor, a multi-cycle incrementing stroking tool, and a jetting sub with multiple nozzles. The anchor is designed to prevent axial motion of the jetting head while jet cutting. It was observed that the required fracture initiation pressure after the jetting operation was reduced and the post-stimulation treatment resulted in an eight-fold increase of gas productivity. In field, the treatment took longer than expected. It was concluded that regular sand is recommended for cutting operations to reduce erosion on nozzles and tool.

An alternative concept to conventional stimulation (like hydraulic fracturing using proppants or acid) is presented by Freyer and Shaoul (2011). The so called "fishbone laterals" consist of typically 100-200 small diameter "needle" holes with a length of 12 m each that trunk-off a main horizontal well. These fishbone laterals can be drilled with significantly lower environmental impact and with significantly lower costs compared to conventional hydraulic stimulation. The formation can be jetted either with water or acid. Simulations have indicated that the productivity of a well can be increased by 20-30%. With 160 needles of 24 m length, a well produced at equivalent rates to 3 propped fractures. The authors identify potential applications of such needle multi-laterals as follows:

- Low permeability reservoirs
- Compartmentalized reservoirs
- Reservoirs which do not allow hydraulic fracturing
- Reservoirs with insufficient depth accuracy for sweet spot well placement
- Multilateral wells where the laterals can be stimulated
- Reservoirs with scaling potential
- Reservoirs with low vertical permeability

McAfee et al. (2014) has written a United States patent application on system and apparatus for a jet-fluid cutting nozzle. The application is related to the cutting of computer programmed shape and window profiles through a wellbore casing with a minimum inner diameter of three inch. The cutting nozzle assembly consist of a hose for receiving the abrasive jet cutting fluid, a helix spring rotatably attached inside the hose, and the nozzle connected to the hose. Rotation of the helix allows for increasing the abrasive jet pressure downhole.

The efficiency improvement as a result of abrasive jet perforation was investigated by Chernyshov et al. (2015) in oil wells in the Perm region. A technology to generate slotted channels was developed. Such deep slotted channels have a length of 0.25 m, a depth of 0.4 m and a width of 0.04 m. The abrasive jet perforation reduces the occurrence of high pressures observed for explosion based techniques. For explosive perforation, pressures of 100 MPa were observed 50 m above to 50 m below the perforation point. Abrasive jetting



does not damage the reservoir and the slotted channels provide the potential for directional hydraulic fracturing. The jetted channels reduce the stress in the near well bore area and increase the reservoir properties of the production layer. An increase of production by 50% was observed. Chernyshov et al. (2015) recommend to use this technology for: (a) thin layers at short distance to water-oil or gas-oil contact; (b) reservoir intervals with a high degree of wear of casing, critical state of cement, partial or no contact; (c) porous carbonates or siliclastics; (d) layers with contamination zone of up to 2m; and (e) layers which are located next to an aquifer.

3.6 Jet Assisted Drilling

This section refers to a hybrid technology of conventional mechanical rock destruction by rotary bit technology as well as water jetting. Although already mentioned in previous sections, the main developments for jet assisted drilling are reviewed here. For jet-assisted rotary drilling the bit contains jetting nozzles which will assist the mechanical breaking of the rock. By means of the jet-assisted drilling the penetration rate can be increased by a factor of 2-3.

In 1973 Maurer et al. (1973) extended conventional roller-cone bit technique to high pressure roller-cone bits containing nozzles and tested this assemble in the laboratory (Figure 4). At 3.44 MPa, the jet was not eroding the Berea sandstone but at 15.86 MPa the jet cut deep slots ahead of the bit. In case hard rock is encountered which cannot be eroded by the jet, the roller cone bit will drill through. The penetration rate at 3.44 MPa and 15.86 MPa was measured to be 1.52×10^{-3} and 3.22×10^{-3} m/s. Maurer et al. (1973) concluded that a certain threshold nozzle pressure must be exceeded before high-pressure bits will erode rock rapidly. Furthermore, high-pressure roller-cone bits operating at pressures of 68.9 to 103.4 MPa can drill most rocks two to three times faster than conventional roller cone bits.

The first paper on high-pressure drilling, published by Maurer et al. (1973), drew five conclusions. Deily (1977) re-examined the previous conclusions based on the experience gained during drilling five additional wells in sand-shale sequences with a cumulative depth of 7695 m. It was concluded that rock removal can be enhanced by improved cleaning at high jet nozzle pressure even if the threshold pressure is not exceeded. At depths greater than about 2100 m, improved cleaning, by the jet, contributed to a moderately increased rate of penetration (30%). The authors firstly mentioned that the rock removal mechanism is affected not only by rock type and depth of burial but by pressure differential into the formation. Although only one well out of the five reached the operation pressure of 68.9 MPa, penetration rates about twice compare to those of conventional bits were achieved. With operation pressures of about 41.4 MPa, an overall penetration rate increase of 55-60% could be achieved.

In order to make jetting applicable to all situations, Pols (1977a,b) investigated high-pressure penetration of isotropic rock and drilling of laminated formations. The author intended to show the potential of jet-drilling in hard, impermeable rock in comparison to



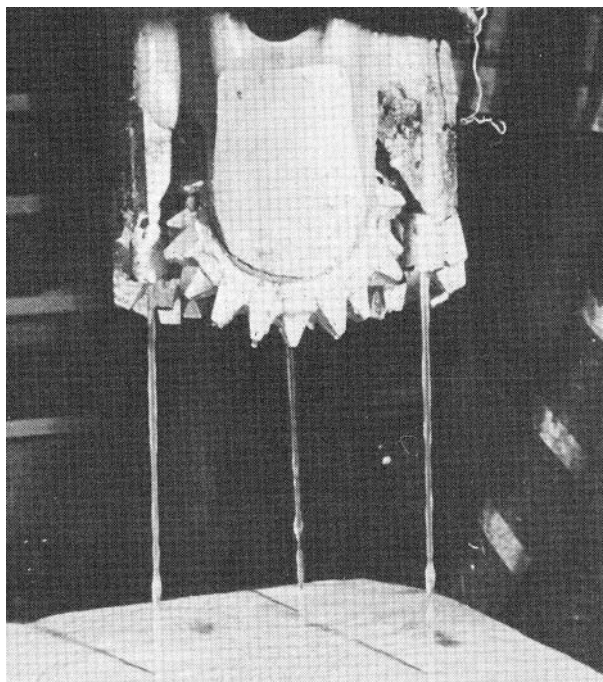
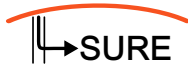

Figure 4: Jet assisted high pressure roller bit (Maurer et al., 1973).

permeable rock. For the tests, Solnhofen limestone, Belgian limestone, Carrara marble, Gres bleu, Quartzitic sandstone, and Martelange schist were used. A bit with a groove distance of three nozzle diameters was designed for the tests; the outward inclination of the nozzles increased from nearly 0° near the centre line to over 45° at the gauge. Maximum pump and ambient pressure was 100 and 400 MPa, respectively. He concluded as follows (Pols, 1977a,b): Hard, laminated rock cannot be jet-drilled satisfactorily without additional mechanical cutting aids. The higher the bit pressure drop, the higher the penetration rate. The increase in penetration rate with bit-pressure drop is much lower for impermeable rock than it is for permeable rock. Drilling mud can have either a positive or a negative effect on penetration rate. Hard, isotropic, sedimentary, impermeable rock can be drilled at higher rates using jets in comparison with conventional bits.

Hood et al. (1990b) review a number of publications on water-jet assisted drilling and concluded that jet-assisted drilling can significantly reduce the required tool force during mechanical rock breakage. In addition, the mechanical tool is effectively cooled, decreasing the thermal load and therefore increasing the bit life.

In 1991, Kolle et al. (1991) further investigated an ultra-high-pressure, jet-assisted drilling system. The two effects of jet-assisted drilling systems were identified to be cleaning and kerfing. To improved cleaning efficiency during drilling, hydraulic nozzles on the drill bits can be used to generate dynamic pressures that can overcome the hold-down forces and remove rock chips from the bottom rock surface. To determine the threshold pressure for kerfing, a series of tests was. If the jet pressure is sufficient to overcome



Report on Deliverable

Version 10/31/2016	Project SURE - Grant-Number 654662	page 25 / 55
--------------------	------------------------------------	--------------

the threshold pressure, it will erode the rock directly. Three rock types tested in laboratory experiments: Colton Sandstone, Bonne Terre Dolomite and Mancos Shale. It was observed that the permeable sandstone sample benefited most from jet assisted drilling. Drilling results were obtained by field experiments which have been divided into soft formations (consisting primarily of sandstones) between 185 and 335 m depth and harder carbonates between 365 and 520 m depth. The rotary speed during drilling was 60 rpm. The next series of drilling tests was carried out in West Texas Dollarhide Field to drill a 200 mm hole in dolomite and anhydrite between 900 and 1500 m. The third series of tests for jet-assisted drilling was performed in two wells drilled in the East Texas Carthage Field. For the field and laboratory tests Kollé et al. (1991) concluded: (1) Permeable formations may be kerfed with jets operating at pressures of 140 to 172 MPa, and these kerfs can improve significantly the ROP; (2) laboratory results indicate continuous increase in ROP enhancement as the jet assist pressure increases; (3) a 2.1 times improved ROP was observed in limestone with a threshold pressure of 241 MPa; (4) ROP improvement of 2.4 times averaged over a 1500 m interval was observed, with the greatest improvement occurring at the highest jet pressures; and (5) the jet-assisted ROP can be correlated to the formation shale content.

Veenhuizen et al. (1997) discussed the efficiency of jet assisted drilling for shale, limestone and sandstone based on laboratory and field data. In order to increase the rate of penetration, an ultra-high pressure (206.8 MPa) fluid jet was added to a conventional TCI roller cone drill bit. The jets cut a small kerf in the rock which enhances the mechanical drilling action. For the field experiments, the required pressures were generated by a downhole pump. The research was supported by laboratory experiments and a finite element model. The ROP increase suggested by the finite element method and laboratory experiments were 3 and 2 times, respectively. All in all, ultra-high pressure jet-assist (UHP) were found to increase the ROP and reduce the weight on bit. It was observed that the in-situ horizontal stress has no effect on the drilling performance but the vertical stresses may influence the drilling performance for impermeable rocks. To support the drilling, the jetted kerf must be deep enough and the required nozzle pressure must exceed a certain threshold pressure. The authors recommend to place the nozzles with a small stand-off distance and to use water instead of drilling mud to increase the jet-ability of the rock. Furthermore, the numbers of nozzles affects the efficiency of jet-assist. The enhancement factor in ROP obtained by laboratory experiments ranges from 1.1 to 2.75. This factor is highest for sandstone and decreases with increasing rock strength and decreasing permeability. The enhancement factors obtained in the field vary between 1.45 in shales, 2.0 in sandstone and 1.5 in granite.

A comparison of rotary diamond drilling with a downhole motor, ultra high-pressure water jet drilling (UHP), mechanical assisted UHP water jet drilling, abrasive water jet drilling and abrasive slurry jet drilling is provided by Kollé (1998, 1999). All approaches have the following common features: rapidly drilling small-diameter holes (25-50 mm), near-surface holes along a short-radius (30 m) arc, and drilling in a variety of hard rock



types. The drilling performance is compared based on the ratio of volumetric rate of rock removal and hydraulic or mechanical cutting power applied. It was observed that the abrasive-slurry jet system loses about half its power in the drill string due to pressure losses. Due to low flow rates used in UHP, well cleaning becomes a concern. For pure rotary mechanical drilling, the mechanical power at the bit is limited. Therefore, the drilling rate is slower compared to the jet-assisted drilling approaches. Mechanically assisted UHP water jet drilling provides slightly higher drilling rates, but elevated torque loads were observed. UHP water jet drilling is capable of rapidly drilling small-diameter holes in a wide range of erosion-resistant rock types and the system can be steered by non-rotating bent housing.

According to Maurer (2002), high pressure jet bits can drill many formations 2 to 3 times faster than conventional bits. In combination with coiled tubing it can significantly reduce drilling, completion and workover costs in many areas and is ideal for underbalanced drilling. The objective of the study by Maurer (2002) was to develop a high-pressure slimhole motor for use on CT to overcome the drill pipe tool joint leakage problems. Three types of downhole motors and two basic high-pressure CT systems were evaluated. A single-flow system was tested where high-pressure fluid at 68.9 MPa is pumped down a single CT string to power a motor and deliver high pressure fluid to the bit nozzles. Another dual flow system with two concentric strings was used to deliver fluid at 68.9 and 13.8 MPa for the jet nozzles and downhole motor, respectively. To cut large grooves at the gauge of the hole, it is required to place the high pressure nozzles on the edge of the roller-cone bits. In contrast, polycrystalline diamond compact (PDC) bits allow to distribute the nozzels across the entire hole bottom. The benefit of high-pressure CT drilling systems is that they can drill 2 to 4 times faster than conventional drills and reduce costs for rock excavation by up to 50 percent.

An analysis of high-pressure jet drilling and mechanically-assisted jet drilling was carried out to determine design specifications for a downhole intensifier and the bottom-hole assembly (Kolle and Theimer, 2005). During high-pressure mechanically-assisted jet drilling an intensifier would be run together with a conventional positive displacement motor. High-pressure jet drilling that uses a jet rotor tool to drill rock without any mechanical cutters is shorter and allows for drilling of short radius holes (Figure 5).

It was shown that flow rates and surface pressures are compatible with available coiled tubing drilling practices. Two-phase flow or clear water flow with sufficient flow rates was evaluated to provide the required cutting cleaning efficiency in both, the vertical and horizontal sections. A review of available jet drilling data shows that 70 MPa jets allow high-pressure jet drilling at economic rates in conventional, non-fractured, oil and gas producing formations. It was also shown, that the jet drilling bit is easier to steer than a mechanical drilling bits. Furthermore, this review provides detailed information on erosion specific performance as a function of pressure, relationship between rock matrix permeability and threshold pressure as well as differential pressure and predicted rate of penetration.



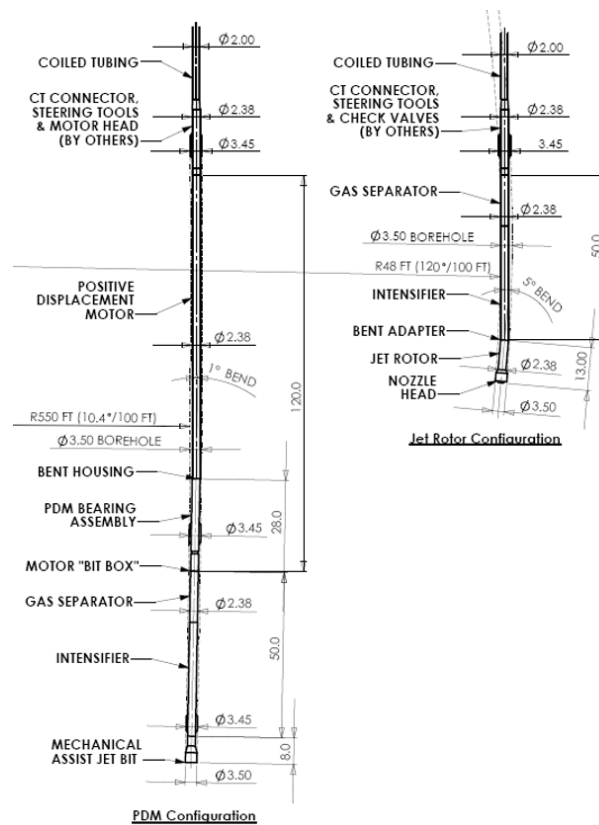

Figure 5: Bottom hole assembly configurations for high-pressure jet drilling (Kolle and Theimer, 2005).

Version 10/31/2016	Project SURE - Grant-Number 654662	page 28 / 55
--------------------	------------------------------------	--------------

Kolle et al. (2008) stated that rotary jet drilling can increase the rate of penetration with reduced weight on bit. In order to use conventional pumping equipment and coiled tubing for rotary jet drilling, a pressure intensifier and a gas separator was developed. The conventional pumps generated operation pressures of 28 MPa. A 2.5:1 intensifier allows for jetting at 70 MPa which is provided to the nozzles. During two-phase operation, separated gas can be used to power the intensifier. The BHA can be used for milling the casing as well, but the rate of penetration is much lower than for a motor and mill. Therefore, an application is a 28.6 to 92.1 mm diameter lateral with an ultra-short radius.

A jet assisted PDC was designed to operate for geothermal or other high temperature well applications by Kolle (2009). A feasibility study on turbine motor and several jet-assisted drill bits for geothermal applications was conducted. Several experiments on basalt, granite and cement were conducted. It was found that the cutter life of the jet-assisted PDC was below the objectives it was concluded that thermally-stabilized diamond cutters are required and low vibration bit designs were recommended to extend the cutter life. It was demonstrated that ultra-high-rotary speed, jet assisted turbodrill can penetrate granite at high speed with low weight on bit and torque. Jet nozzles are capable of providing significantly better jet erosion and cooling performance. For enhances geothermal systems, Kolle (2009) stated that laterals required a minimum depth of around 100 m to obtain required well conductivity.

Rotating mechanical drilling in hard rock (uniaxial compressive strength more than 100 MPa) requires a more efficient drilling technique. Therefore, a hard rock mechanical drilling technique with the abrasive water jet assistance was developed by Lu et al. (2013). For this system, the abrasive water will erode the "boss" for a "pilot hole" (Figure 6). The newly generated free surface acts as a guide for cracks to the subsequent rock breaking and promote the cutting edges to overcome the rock strength. The designed and manufactured drilling bit was tested during laboratory experiments. The results indicate that drilling bits with the assistance of abrasive water jets can increase the drilling depth by 63% and reduce the thrust force and torque by 15% and 20%, respectively. Furthermore, the integrity of the cutting edges will be maintained which extends the life of the bit.

The lessons learned and best practices of jet-in and drill-ahead operations were presented by Maniam et al. (2014). 22 jet-in and drill-ahead BHA runs for deepwater drilling in Malaysia were reviewed. The objective of a jet-in and drill-ahead operation is to set the surface casing and drill the following well section without changing the BHA. For such kind of operations, the bit size, jet-in procedure, jetting speed, bit extension, assembly type, flow rate, formation and survey procedures were evaluated. It was found that jet-in and drill-ahead techniques are faster than conventional methods. Typically a 0.914 m size conductor casing will be jetted using a BHA consisting of a mud motor and a directional measurement while drilling assembly. If the desired depth is reached a soaking period is required. After this period the BHA will be released from the drill-ahead tool and drill to section total depth.



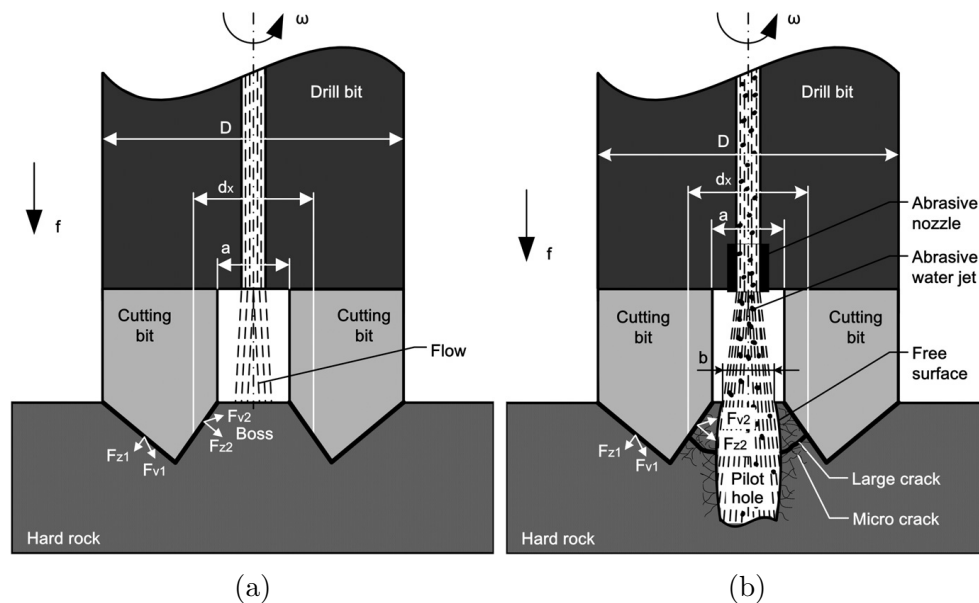

Figure 6: Drilling principle schematic diagram of (a) common rotary bit with flow and (b) hard rock breaking technique with abrasive water jet assistance (Lu et al., 2013).

Based on theoretical analysis and laboratory experiments a mechanical-specific-energy (MSE) model for pulsed-jet assisted rotary drilling was established (Minghui et al., 2016). This model indicates that the major influence of pulsed water jets on the ROP are a changing breaking strengths of the rock as well as an improved cutting cleaning efficiency downhole. The MSE values for pulsed water jets are 20% to 70% less than those for conventional drilling. According to the authors, based on the MSE model, downhole conditions can be evaluated and abnormal conditions can be detected in real time.

3.7 Horizontal Radial Drilling and Ultrashort-Radius Radial System (URRS)

First papers on radial water jet drilling (RJD) were published in 2001. Before 2001 several publications on horizontal radial drilling were published which are similar to the RJD technology but differ in detail. For example the quick radial system can be used to drill from a vertical to horizontal well with a 6 to 15 m radius. The ultrashort radius radial system is capable of deflecting from vertical to horizontal with a 30 cm radius using a whipstock assembly. This technology is close to RJD which uses a deflector shoe. Precursors to the RJD technology are reviewed in this section.

The goal of the work by Dickinson and Dickinson (1985) was to drill multiple horizontal wellbores, called "radials", from an existing well and to concurrently place a metal tube into these holes. From the project, the following objectives evolved: (1) Drill mul-



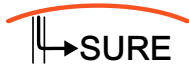

Report on Deliverable

Version 10/31/2016	Project SURE - Grant-Number 654662	page 30 / 55
--------------------	------------------------------------	--------------

multiple horizontal radials (101.6 mm diameter) of predetermined direction, 30.5 to 61 m in length from a single existing oil well even in unconsolidated formations. (2) Complete the radial with a 31.75 mm production tube while drilling is in progress. (3) Cut off the production tube downhole. (4) Log the geometry of individual radials/production tubes. (6) Provide the possibility for perforation and sand control. For the system as designed above, a 254 to 304.8 mm radius turn from the vertical to the horizontal is required. Depth and direction are determined by a whipstock assembly. Jet drilling was performed with a non-rotating nozzle applying a pressure of 55.2 to 68.9 MPa, corresponding to a nozzle velocity of approximately 300 m/s. While drilling, the production tubing was progressively placed within the radials. The drilling velocity was regulated between 3.05×10^{-2} and 6.10×10^{-1} m/s. Flexible logging and electronic packing systems were developed and applied to log the jetted trajectory. In addition, new procedures for gravel packing and flexible lining of the production tubing were developed and tested in field applications.

Dickinson et al. (1989) reviewed the progress of URRS development. Starting initially with multiple horizontal laterals from a single level, multiple horizontal radials were also placed on multiple levels. Horizontal completions were successfully applied, including 100%-filling gravel packing, in-situ electrolytic perforation and cutting as well as flexible sand barriers. Field tests were limited to unconsolidated formations. The following ten capabilities were demonstrated in field applications (Dickinson et al., 1989): (1) ultrashort radius radials (vertical to horizontal turn on 30 cm radius); (2) multiple radials on the same level or multiple levels; (3) rapid penetration with conical jets; (4) case while drilling; (5) control while drilling; (6) 3D radius of curvature survey; (7) 100%-fill bidirectional gravel packing; (8) electrochemical cutting and perforating; (9) flexible sand barriers; and (10) horizontal completions. The percentage improvement for two specific wells in unconsolidated formations was measured to be 50 and 365%, respectively. The limitations of these technique are the requirement for real-time control of the drill string trajectory when it extended beyond the 10 m zone of whipstock influence on the trajectory. Systems to actively influence the geometry of the trajectory were in test.

Based on the promising results, Dickinson et al. (1990) focused on data acquisition, analysis and control while drilling with jet drilling systems. The two jet drilling systems are: The Ultrashort Radius Radial System (URRS) and the Remotely Piloted System (RPS). URRS is an extended completion or re-completion system built around 32 mm coiled tubing and designed to provide 30 to 60 m radials on one or several levels within a single vertical well. RPS can be used to provide multiple radials at trajectories of up to many kilometres in length. The URRS Control While Drilling has demonstrated the capability in the field to control the drill string trajectory to within 1.1 to 1.5 m vertical for a 30 m drill holes. Rate of penetration can be controlled from 6 m/min down to 0.15 m/min. The horizontal trajectory is not controlled. The RPS control system was designed and tested to drill as a true remotely piloted system. The objective is to achieve a highly accurate, controlled trajectory of the 114 mm drill string for many kilometres.

One of the first reviews on long and ultrashort turning radius of horizontal wells



was performed by Toma et al. (1991). The authors summarized the potential of production enhancement by ultrashort radius radial systems including; jet drilling with aqueous solutions; drilling of multiple branches; 3D positional survey; radial completion-flexible sand barrier and horizontal gravel packing; low productivity reservoirs. Ultrashort radius technology was found to have potential to increase the oil production rate two- to ten-fold. It was demonstrated that horizontal wells include a large drainage area, accesses vertical fractures, and reduces the adverse effects of water and gas coning. URRS can typically be used for horizontal drilling for thin reservoirs to extend the reservoir areas to the well while considerably reducing the near-wellbore pressure drop. Furthermore, horizontal wells enhance heat transfer due to increased contact between cold reservoir and hot injected fluids and improved fluid communication within the reservoir. Toma et al. (1991) mentioned some application for enhanced oil recovery in thin heavy oil reservoirs which are not listed here. But the authors remarked that the knowledge about the permeability distribution and skin factors allow to predict the enhanced production performance.

Two different systems of placement of multiple extended completion radials using water jet drilling with a coiled tubing drill string were described by Dickinson et al. (1992a) - the Ultrashort Radius Radial System (URRS) and the Quick Radial System (QRS), see Figure 7. In the QRS, the coiled tubing drill string enters the formation by abrasively penetrating the casing so that no section milling nor under-reaming of a downhole cavity is required. For both systems, side thruster water jets can be used to control the trajectory of the radials. In contrast to URRS, QRS allows for multiple radials, completed back to the surface. QRS was designed to provide substantially lower cost than the URRS. Whereas URRS is capable to perform a vertical to horizontal turn with a 30 cm radius, QRS can be applied with a short radius, 6 to 15 m, a medium radius, 30 to 90 m or even a long radius, 300 to 1500 m. Both systems can increase production by generally two to ten times as compared to offset vertical wells for both light and heavy oil.

A similar study was performed by Dickinson et al. (1992b) focusing on the thermal recovery of heavy oil. The authors report that multiple radials (up to 20 per layer) and multiple layers (up to 5 layers) have been successfully drilled. During the field tests, water coning, natural fracturing, hard-soft inclusion, shale partition, faulting, and other reservoir heterogeneities was encountered. The following conclusion were repeated and extended: (1) horizontal radials increase the effective wellbore diameter by many times and effectively penetrate the near well bore damage zone; (2) radials probably change the pressure gradient within the reservoir; (3) radials can access areas containing oil that is otherwise immobile; (4) cyclic thermal application enhance the productivity; (5) radials favourably affect reservoir temperature to their furthest extend; and (6) radials are eliminating the negative effect of steam override conditions.

Dickinson et al. (1993) investigated the capabilities of URRS with special focus on the skin factor. The skin factor includes any effect of restriction to flow into a wellbore. The authors present field results, theory, and practice radials placed by coiled tubing water-jet drilling. Another focus of this study was the completion for the radial drain holes which depend on specific client requirements: open hole, electrolytically perforated



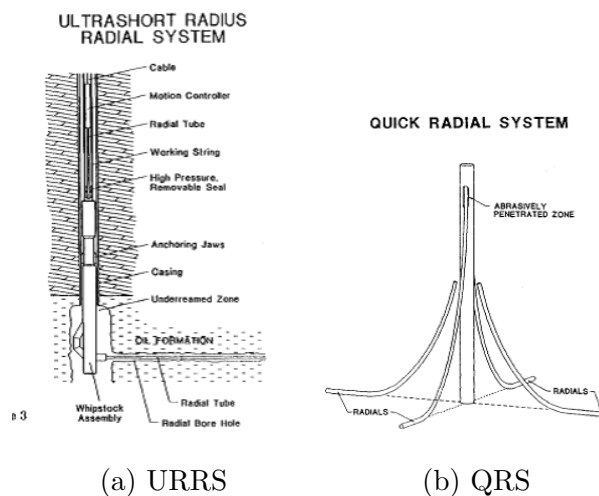

Figure 7: (a) The Ultrashort Radius Radial System (URRS) and (b) the Quick Radial System (QRS) (Dickinson et al., 1992a)

coiled tubing, flexible permeable casing (Flexible Sand Barrier), and horizontal gravel packing. For most applications, the radial drain hole can be completed as an open hole (consolidated rock) or gravel packed (unconsolidated rock). According to Dickinson et al. (1993), field data associated with the application of multiple radials of 8 to 30 m indicate: (1) improvement in productivity factors of two to four in undamaged reservoirs; (2) for wellbore damage (skin), created by the infiltration of drilling fluids or fines migration, the enhancement effect can be calculated to be five to ten; (3) the production enhancement effect is generally further enhanced in thinner reservoirs with radials (8 m as compared to 30 m); and (4) Multiple layers of radials are relatively more effective in the thicker reservoirs.

Wellbores with multiple forked branches and laterals which reduce overall costs, increase production and improve reservoir drainage were reviewed by Bosworth et al. (1998). Besides the determination if multilateral technology is applicable, a good overview of multilateral well configuration, classification of multilateral wells, window milling, the progress of drilling multilateral wells and completion is provided. It was concluded that multilateral wells can reduce overall drilling and completion costs, increase productivity by more efficient drainage of the reservoir, and make reservoir management more efficient. Bosworth et al. (1998) state that multilaterals are required for reservoirs with several stacked layers that may not communicate, single layer with critical anisotropy in permeability or geological compartments which do not communicate with each other.

An application of ultrashort radius radial well drilling and completion technique was performed in Jin Well#04-19 and Jin Well#38-303 of Liaohe Oilfield. Li et al. (2000) describes the three key parts of this high pressure jet flow technique: big diameter underreaming technique; design principle of diverting system; and option of well com-

pletion. The technical process is defined as follows: Mill-cut 58 m of production casing as required; ream the mill-cut hole to 660 mm; run the whipstock assembly and jet drill laterally. Thereby the reaming can be performed by pure mechanical reaming, hydraulic power plus quartz sand reaming or hydraulic and mechanical combination reaming. After anchoring the whipstock, the high pressure jet tube is bent and drills a hole with a diameter not smaller than 70 mm. Four completion techniques were discussed: open hole completion, flexible screen pipe completion, flexible screen pipe plus gravel package completion, and hydraulic fracturing and gravel packing completion. It was concluded that this technique can greatly increase the production rate and that high pressure jet flow ultrashort radius radial wells are still at the development stage.

One of the key features in ultra-short radius radial drilling is the jet bit. Guo et al. (2009) designed a jet bit which breaks rock, removes cuttings, enlarges the drill-holes, and produces sufficient pulling force. The backward nozzles (thrusters) produces a steady low pressure zone in the annulus which can enhance the rate of penetration. At the jet bit, a pressure drop occurs which is the main factor in producing the pulling force. The introduced pressure coefficient which is defined as the ratio of pressure difference and flow rate depends on the flow rate as well as the hole diameter. This pressure coefficient increases linearly with the flow rate. For small hole diameters, the rate of increase of flow rate is higher. Pulling forces of about 8.000 N at flow rates of 2 l/s could be observed experimentally.

A review of URRS was performed by Marbun et al. (2011). The authors summarize that the curvature alteration from vertical to horizontal turns in 30 cm and that laterals of up to 100 m length with diameter of approximately 5.08 cm can be achieved. The required equipment to perform URRS can be summarized as follows: (1) workover rig; (2) fracturing system tool; (3) data acquisition tool; (4) anchor system; (5) cutting, milling or perforation BHA; (6) jet drilling; (7) wireline logging system; and (8) underreaming tool. After finishing the jetting process the completion e.g. open hole; flexible screen pipe with or without gravel pack or hydraulic fracturing with gravel pack is performed. Prior to the jetting process the geologic condition, the reservoir properties, the well configuration and the production have to be considered. Furthermore, it was concluded that hole cleaning is one of the important parameters in URRS operations to achieve success.

Dongjun et al. (2012) established a model of calculating the circulating pressure loss in coiled tubing ultra-short radius radial drilling. It was concluded that the pressure losses in spiral parts are greater than that in the straight parts considering that coiled tubing length and diameter are identical. Assuming a constant flow rate, the pressure losses in a 2.54 cm coiled tubing are 8 to 10 times higher than in a 3.81 cm coiled tubing. In this study, the pressure loss in the high pressure hose are 86% of the total pressure loss in the circulation system. Adding drag reducer to the fresh water can reduce the pressure loss by 50%.



4 Radial Water Jet Drilling

Within this section, the development of the radial water jet drilling (RJD) technology is described. The technology is based on the development of the water jetting technology described in section 3. First, the historical development is reviewed. Afterwards, the current industry state-of-the-art (Section 4.3) is presented, together with a short evaluation of the economics (Section 4.4), the environmental impact of an RJD operation (Section 4.5) and a site application (Section 4.6).

4.1 Development of RJD technology

An overview about the different studies on RJD is provided in Table 1. Relevant publications describing RJD are reviewed in this section.

In 2001, a study by Buset et al. (2001) describes a new coiled tubing conveyed drilling technique suitable for both existing and new field developments. The main objectives were, to penetrate the damaged skin zone, and connecting to possible hydrocarbon pockets left behind to the mother well. The bottom hole assembly was designed to jet-drill several laterals (50 m long, and 25-50 mm diameter), all in one coiled tubing run. The tool was designed for operation in wells with an inner diameter of 114.3 mm or larger. Environmental conditions with temperature and pressure of 120°C and 690 bar were considered. The assembly consists of two main parts; a casing drilling machine and a high-pressure hose and jet-nozzle. This technique was designed to be a substitute or supplement to acid and proppant fracturing. The tool operation has the following steps (Buset et al., 2001):

- lower the assembly down to the reservoir target depth
- attach the tool to the casing wall by an anchor
- drill a hole in the casing
- stroke out the telescopic joint to position the nozzle head
- jet a lateral into the formation
- retract the telescopic joint
- reposition the tool
- repeat the procedure, and pull out

Besides reservoir permeability, skin effect, ratio between the vertical and horizontal permeability and oil viscosity, the self-induced nozzle pull force was considered (Figure 8). The self-propelled nozzle also provides the required forward force to pull the high-pressure hose into the lateral.



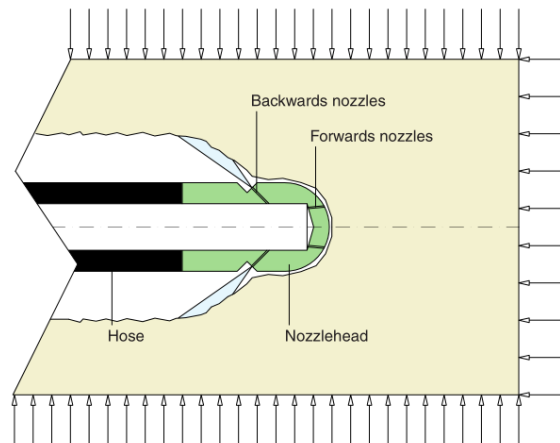

Figure 8: Sketch of the nozzle (Buset et al., 2001).

Buset et al. (2001) concluded as follows: The benefit of laterals increases with decreasing reservoir permeability and is most profound in reservoirs with high kK_v/k_h ratios; penetrating the skin zones has big impact on total productivity; and best change in productivity is seen in high viscosity reservoirs. A productivity increase between 2 and 4.6 could be achieved by numerical simulations for 1 and 6 laterals, respectively.

An evaluation of radial drilling was performed by pilot tests in 22 different shallow and deep oil field in Argentina (Bruni et al., 2007). The technology applied involves drilling lateral horizontal bores of small diameter. First, the casing was perforated with a 19.1 mm mill. Afterwards, the lateral extension was performed by high pressure water jetting. From an operational point of view the jobs were successfully performed. But a high uncertainty about the orientation of the perforation exists. Furthermore, the productions increase was not as high as expected. Experience shows that detailed knowledge of the petrophysics, rock mechanics and pressure response are required. Tubing string testing (TST) and build up tests, however, demonstrate that the laterals passed the damage zone in the near wellbore area and reached better permeability conditions.

Radial perforation technology with hydraulic jets and coiled tubing was performed by Repsol YPF Bolivia (Cirigliano and Talavera Blacutt, 2007) in three deep wells with complex geometry. The existing technology had to be adapted to be tested in the directional wells with a depth ranging from 3500 to 3900 m. After the deflector shoe was positioned and oriented in the desired depth and direction, the casing was perforated using a bottom hole assembly with a 19.05 mm milling bit, a flexible joint and a 43 mm down hole motor (PDM). The BHA was run by a 12.7 mm OD coiled tubing. After perforating the casing, the BHA for radial jetting with a 12.7 mm jetting bit and a 100 m flexible hose was run by a 12.7 mm CT (Figure 9). The jetting nozzle was equipped with backward and forward directed nozzles generating the pull and erosion effect, respectively. Due to

operational problems 602 out of 800 m were successfully drilled in well 'one'. In well 'two' it was impossible to perforate the casing. In well 'three' 81 out of 600 m were drilled. Although problems and limitations exist, it was shown that radial perforation is possible in this type of rock.

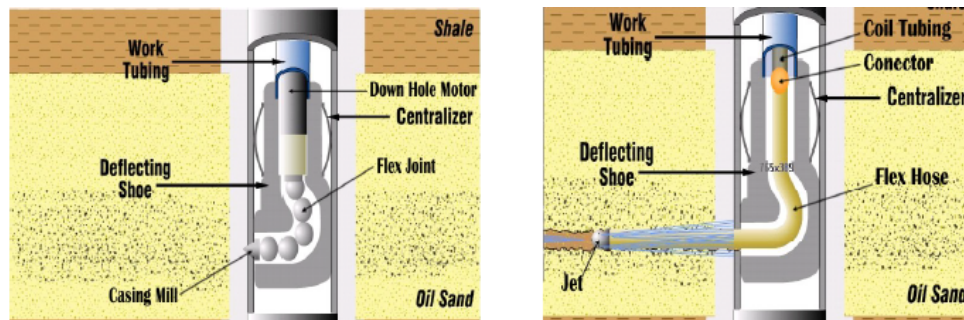

Figure 9: BHA for casing perforation (left) and radial jetting (right) (Cirigliano and Talavera Blacutt, 2007).

The same method as described by Cirigliano and Talavera Blacutt (2007) was applied by Rohöl-Aufsuchungs AG (RAG). It was used as a stimulation and exploration method (Seywald and Marschall, 2009). A flat spring of the centralizer is placed on the back side of the deflector shoe to press it towards the casing. The same standard jetting procedure was applied. It was reported that if the nozzle respectively the hose is getting stuck, it is possible to shear off the hose at the deflector shoe. Laterals with a diameter of 50 mm and a length of maximum 100 m could be drilled.

The success of radial water jet drilling was investigated by Abdel-Ghany et al. (2011) by use of numerical simulation and field tests. In a field experiment, 50-100 m long horizontal laterals with a diameter ranging from 30-50 mm were drilled from an existing well. By numerical simulation an increase of productivity between 200 and 300% was estimated for 1 to 4 radials, respectively. In the field, the radial drilling process was performed in three wells with 4, 6 and 7 laterals. The maximum achieved increase of productivity was 173%. Besides these results the advantages and limitations of radial jetting technology were presented:

Advantages:

- By-passing a damaged zone.
- Extending drainage area
- Improving drainage from low permeability, heterogeneous and layered reservoirs.
- Connecting fractures to the wellbore

The service provider used for the experiments reported by Abdel-Ghany et al. (2011) reported the following limitations for radial jetting operations:



Version 10/31/2016	Project SURE - Grant-Number 654662	page 37 / 55
--------------------	------------------------------------	--------------

- Porosity should be higher than 3-4%.
- Maximum working depth about 3000 m.
- Maximum Pressure rating of the CT 690 MPa
- Maximum wellbore inclination 30 degrees (15 degrees at the target zone)
- less than 120°C wellbore temperature

A technology status assessment and a research outline is presented by Balch (2011). The jetting procedure discussed is similar to previous studies: (1) a casing-drilling machine will drill a hole through casing and (2) several slim laterals will be jet-drilled using a coiled-tubing. By the outlined research the production enhancement from marginal wells by radial water jet drilling will be demonstrated. The results will be validated by numerical simulation.

Elliott (2011) reported about radial water jet drilling performed in five wells, to improve oil production from depleted reservoirs. 4 radials of 50-mm diameter up to 100 m length were drilled at one level (at right angles to one another). To improve jet-ability in carbonate rocks, the laterals were jetted with 10-15% hydrochloric acid during drilling. In all wells, a significant increase of production could be achieved. However, the increase was not sustainable for some of these laterals. The non-sustainability of the production increase was explained by an overall decline in reservoir pressure.

In the Donelson West field, located in Cowley County, Kansas, the porosity varies between 15 to 20%, while permeability varies between 1 to 10 and the net pay thickness is typically between 1.8 and 3 m (Cinelli and Kamel, 2013b). In this field two new wells were drilled and completed with RJD laterals and subsequently fractured with acid and nitrogen. In addition, eight older wells were treated similarly. The applied RJD procedure was as follows: (1) removing the production equipment and rig up the CT unit; (2) work-over tubing with a 90-degree deflector shoe is lowered down until the deflector shoe reaches the target formation; (3) the milling BHA is run on the CT to perforate the casing and cement; (4) a high pressure hose with a jet nozzle is connected to CT; (5) drilling fluid exits the nozzle at high speeds, erodes the reservoir and drills the laterals. One of the old wells failed to produce oil after the treatment the other old wells indicate a two fold increase in production. Furthermore, it was shown that RJD can be effective for completing both new and old wells with radials up to 100 m due to its low environmental impact, economical enhancement, suitability, enhanced effectiveness of subsequent well stimulation treatments, and the speed of drilling (Cinelli and Kamel, 2013a).

The coiled tubing hydra-jet sidetracking of radial micro-borehole technology was verified by yard tests (Figure 10) and field tests by Gang et al. (2013). During the experiment, the pressure loss in the high pressure hose increases linearly with the increase of flow rate. The self-propelled force of the jet bit is large for borehole diameters ranging





Figure 10: Yard test on porous concrete blocks (Huanpeng et al., 2013)

from 30 to 50 mm and increases with increasing flow rate. Furthermore, the self-propelled force increases when the forward and backward flow ratio of the jet nozzle decreases. During the yard test, the casing opening time was about 15 min. A horizontal drill hole of 20.6 m length and 50 mm diameter was completed in 97 min which corresponds to a penetration rate of 0.21 m/min. During a field test, 4 radial horizontal laterals were drilled in the Jin 17-1 well. The length and rate of penetration was 20 m to 50 m and 0.2 m/min, respectively.

A pressure loss model of the radial drilling system and the pulling force model of flexible hose connecting with the jet nozzle was developed by Huanpeng et al. (2013). The method to calculate the maximum length of the lateral was verified by yard tests (Gang et al., 2013). By means of the model a sensitivity study including the effect of flow rate, pump pressure, ratio between the flow rate of the forward and backward orifices of the jet nozzle, well roughness, mother-well depth, and well diameter was carried out. Model results were validated using data from on-ground yard tests. It can be concluded that an optimum flow rate ratio of the forward and backward orifices of the jet nozzle exists, which is 1.0. The maximum length of the lateral is most sensitive to pump pressure, flow rate, well roughness and flow rate ratio.

An increase of productivity in an Egyptian oil field using radial drilling technique was shown by Ragab (2013). The productivity of three wells with depths between 2699 and 2739 m was improved by radial drilling technique. In each well 4 to 7 laterals with length of 50 to 90 m and an angular separation of 90° were drilled. The gross rate increased by 14 to 73% and the net oil rate increased by 15 to 47%. Ragab (2013) report that the results indicate that: (1) holes were drilled successfully; (2) the well which has the deepest lateral hole length show a significant increase in production rate; (3) this technique works not well in un-consolidated formations; (4) multiple horizontal radials can be drilled at the same level in a single well; (5) an increased oil recovery and oil production rate can be achieved; (6) rock mechanics must be considered and research and testing of the jet nozzle penetration mechanism are required; (7) radial drilling is easy to be apply and less expensive; (8) that it is necessary to have petrophysical studies before the drilling; (9) completion improvement such as gravel packing or using slim tubes is needed. Furthermore, benefits

Version 10/31/2016	Project SURE - Grant-Number 654662	page 39 / 55
--------------------	------------------------------------	--------------

and limitation of radial drilling method are mentioned which are similar to Abdel-Ghany et al. (2011). In a second publication reporting about the increase in well production in the same oil field in Egypt (Ragab and Kamel, 2013), similar conclusion were drawn. The conclusions were extended by the following points: (10) the higher the hole number, the higher the production rate; (11) key issue is sustainability of the productivity increase.

In the 40 year old Donelson West field, radial water jet drilling was effectively used to re-complete several mature wells (Kamel, 2014). An increase of oil production indicated a success of RJD and performed acid treatments. It is uncertain, however, which particular mechanism caused the production increase. The simplest explanation is that laterals increase the amount of rock to be accessed. Furthermore, laterals can change the flow regime from radial flow to more linear flow. In limestone, laterals can open vugularity, natural fractures can be connected to the mother well and laterals aid fracture propagation. The use of acid as the jetting fluid and subsequent acid fracturing, however, may be a contributing factor as well. Kamel (2014) suggest that it is probable that a combination of these factors caused the increase of production.

Kohar (2014) performed a short review on the radial drilling technique for improving recovery from existing oil fields. The review field cases are the RJD technique applied in Belayim land oil field in Egypt by Petrobel Company and the RJD in Kalol VIII reservoir, Ahmedabad, Gujarat done by Selan Exploration Technology Limited. It is concluded that marginal & brown fields will find new ways to survive by use of RJD. Furthermore, new field developing operations can include RJD techniques in their field development strategy.

Radial water jet drilling was performed as a case study to revitalize an aging field in Tarim (China) (Teng et al., 2014). This paper outlines the completion and production history, summarises the workover effort and the change of production. The results indicate that a production increase of almost 300% could be obtained. Therefore, RJD can improve productivity of shallow reservoirs that still have oil in place. Furthermore, it was stated that radial water jet drilling is a low-cost and environmental-friendly method. The field test equipment can be summarized as follows: coiled tubing unit equipped with a 4500 m CT, Downhole motor (PDM) (outer diameter 46 mm, max work temperature 120 °C), Milling assembly (max diameter 27 mm), high pressure hose (max. 40 MPa, max temperature 120 °C), outer diameter 12.7 mm), jetting nozzle (diameter 12 mm, length 14 mm, 3 frontward and backward orifices).

A report on radial drilling (Peters et al., 2015) shows the potential of RJD for Dutch geothermal applications. In this report, the findings, simulation results, conclusions and recommendations for geothermal applications are documented. It was summarized that radial water jet drilling does not require large volumes of water and its application is more controlled than for example hydraulic fracturing, resulting in lower costs and less risk. The formation rock need to have a minimum porosity of about 3-4% to be jet-able. It is required for the main well to have a minimum inner diameter of about 4 inch and



a maximum measured length of about 5 km. Currently, no major risks to the well nor to the environment have been identified. For the well, the main risk appears to be sand production from the open-hole completion. Peters et al. (2015) report on simulation of representative cases that show a potential performance increase by a factor of up to 3 if 8 laterals of 100 meter are successfully jetted and geological conditions are favourable. But major uncertainties in the production estimates are the long-term (>1 year) stability of the jetted laterals.

Peters (2015) investigated the production performance of radial water jet drilled laterals in tight gas reservoirs in the Netherlands. A numerical reservoir simulator was used to compare the production performance of a low permeable (0.1 mD) homogeneous reservoir based on three development options: a conventional vertical well, a vertical well with radial water jet drilled laterals and a vertical well stimulated through hydraulic fracturing. The data shows a recovery improvement for reservoirs with permeabilities lower than 10 mD if the well is stimulated with radial water jet drilled laterals. Peters (2015) state that laterals appear to be most effective in low permeable (0.1 mD) reservoirs with a recovery improvement factor of 2-3.5 compared to a vertical well. Furthermore, the lateral length is the well design parameter that has the most profound impact on the recovery factor.

The pressure loss, ejector force, and extending resistance of an RJD system was measured at different flow rates at a full-scaled RJD experimental facility by Bin et al. (2016). Furthermore, a pressure-loss and lateral-extending-force model was established to optimize the hydraulics of a RJD system. In addition field case of a well stimulated with six radial laterals in four different layers was studied by using the hydraulics-calculation model and optimization design method. It could be shown that the hydraulics calculation model corresponds well with the field data and the model error was within 8%. The pressure losses in the high pressure hose and the drill bit were 41.2% and 55.8%, respectively. The results indicate that the flow rate should be optimized for different well configurations. The study may serve as a guide for the development of safer and more effective RJD practise.

4.2 Numerical Simulation Related to Radial Water Jet Drilling

This section summarizes research publications on the jetting technology based solitary on numerical simulation. Especially the nozzle design and the nozzle's ability to self-propel can be investigated and optimized by numerical simulations. Another area of application for numerical simulation is the prediction of production performance from various kinds of reservoirs. These simulations consider the design (amount, length, diameter, etc.) of the laterals in combination with the reservoir characteristics.

The impact of micro-hole arrays on the production performance of enhanced geothermal systems was investigated by numerical simulation by Finsterle et al. (2013). The synthetic reservoir represents the EGS test site at Soultz-sous-Forêts; France. The reservoir



is simulated by using a dual-porosity approach and the wells and micro-holes are super-imposed in the domain. Although there are some limitations with inserting micro-holes under EGS conditions the authors considered between 27 and 40 potential micro-holes to be drilled. The diameter and length of these micro-holes are 0.064 and 1300 m, respectively. The kick-off angle of the micro-holes is 45° from the axis of the main well at depths ranging from 3.8 to 4.1 km. The simulation indicates, that EGS based on micro-hole arrays could significantly increase production rates and their sustainability by: (1) increase the probability of intersecting flowing fractures; (2) reduce the risk of early thermal breakthrough; (3) increase the preheating of the working fluid in the reservoir; and (4) provide for self-regulated distributions of injection rates.

Diagnostics of radial-jet well stimulation for enhanced oil recovery was performed by Balch (2014). Based on a successful characterisation of the west Millman field (located in the New Mexico Permian Basin) the potential efficiency of radial jetted laterals was evaluated. The characterisation was performed with the assistance of well-logs and core observation. Afterwards a 3D-Blackoil full-field simulation model was constructed and validated through history matching. With the validated model the design of laterals was tested. The result indicate that four emplaced laterals gave an efficiency for enhancing oil production which varies between 28.5% and 33.3%.

Chi et al. (2015) present a mathematical model to calculate the maximum drill-able length of radial horizontal micro-holes with high-pressure water jets. The model was derived from combining theoretical approaches with experimental methods. The model takes into account pressure loss of the circulation system, the pressure and flow rate of the pump, and the self-propulsion effect of the multiple-jet nozzle. The results indicate that the flow rate is the dominant factor in the radial horizontal jet drilling process. The main factor limiting the length of the laterals is the friction of the high pressure hose moving in the diverter and micro-hole. The model for calculating the maximum drill-able length using a self-propelled multiple-jet nozzle was successful validated by a field case and can therefore applied to predict the maximum drill-able length for other field cases.

A semi-analytical tool for evaluating the performance of a well stimulated by radial jetting was developed by Egberts and Peters (2015). Radial jetting is an alternative to conventional hydraulic fracturing. Egberts and Peters (2015) state that 10-20 laterals can be jetted from a single sub-vertical well. Each lateral with a length between 100 and 200 m. Typically 4 laterals are jetted from a single level. The developed tool can compute the productivity performance of such an enhanced system. The results were compared to numerical simulation for three separate reservoirs having permeabilities between 1 and 5 mD and 4 slightly inclined laterals. For the reservoir with 5 mD an increase in cumulative gas production of 10% could be shown. For a reservoir with 1 mD permeability the increase in cumulative gas production is 50% to 70%. The semi-analytical model can straightforwardly be applied for oil reservoirs and even other configuration such as fishbone wells can be considered.



A multi-orifice nozzle (Figure 11) is typically applied for radial water jet drilling purposes. Backwards directed nozzles generate a force to self-propel the nozzle towards the rock surface. Li et al. (2015) studied the ability of the nozzle to self-propel. The developed model can calculate the self-propelled force and defines a factor to represent the self-propelled ability of the nozzle. The results were compared to experiments and to numerical simulations. For the study, the number, angle, and diameter of the orifices on its self-propelled ability was evaluated. The following results were obtained: (a) the number of forward orifices decreases the self-propelled ability; (b) the angle of the forward orifices have positive effect; (c) at an optimal angle, the backward orifices primarily generate the self-propelled force; (d) the orifice diameter can improve the performance but is limited due to flow rate and jet pressure. This study can be used to define an optimum nozzle design.

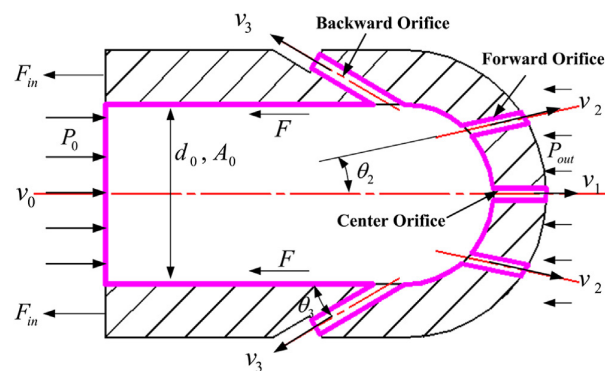

Figure 11: Model of the self-propelled force (Li et al., 2015).

Zhang et al. (2015) investigated nozzle design for high pressure water jetting by numerical simulation. Based on the simulation of three kinds of nozzles typically used in industrial production, a structure optimization focusing on the jetting performance was performed. The study shows that a helix nozzle displays the best jetting performance.

4.3 State of the Art

This section describes the current industry state of the art for RJD using a $\frac{1}{2}$ " CT. In order to get the best results of the RJD operation, a proper petrophysical analysis has to be performed before the operation to determine if a formation would benefit from jetting laterals.

To perform a RJD operation, a deflector shoe connected to a work-over tubing and installed in an existing well using a work-over rig or a crane. The depth and orientation of the deflector shoe determines the position where the lateral exits the main well. The orientation of the deflector shoe is determined using a wireline logging tool. Once the shoe is placed and oriented, the CT is run into the work-over tubing to mill a hole through the casing. The required milling BHA consists of:



Version 10/31/2016	Project SURE - Grant-Number 654662	page 43 / 55
--------------------	------------------------------------	--------------

- CT connector
- Down-hole motor (PDM)
- Flexible cardan shaft
- Milling bit

Once the hole through the casing is milled, the milling BHA is pulled out of hole and exchanged with the jetting BHA. This jetting BHA consists of:

- CT connector
- 100 m high pressure hose
- Jetting nozzle

The jetting BHA is run hole and exists the casing through the previously milled hole. To jet drill a lateral into the formation, fluid is pumped through the CT at high pressure. After jetting a lateral, the jetting BHA is pulled out of hole and the deflector shoe is repositioned. The sequence of milling and jetting is repeated until the desired number of laterals is drilled. The laterals can be up to a 100 m long with an internal diameter ranging from 25 to 50 mm.

The current development considers the application of a rotating nozzles to create a sweeping area and pulsating effect for tough sandstones. Abrasives are considered, but due to material selection, size restrictions and limited flow-rates it is difficult to apply abrasives in field operations.

The current operation limitations are a maximum working depth of 5000 m and a minimum casing outer diameter of 4-1/2". Recent developments have made it possible to apply RJD even in horizontal well sections. Although, the high pressure hose used for radial water jet drilling is not designed to be "pushed" through horizontal well section, results from an internal study at Well Services Group support the feasibility of a technological solution to overcome this limitation.

4.4 Economics

The evaluation of performance increase in the hydrocarbon industry is usually different from evaluating a performance increase in geothermal wells. For oil/gas fields the increase is usually evaluated in terms of cumulative hydrocarbon production or recovery. This depends on the size of the reservoir, permeability, water cut, etc.. For geothermal wells, usually the increase in flow rate is evaluated. Productivity increase is mostly dependent on well geometry. For homogeneous reservoirs, relative productivity increase due to laterals drilled using RJD does not depend on the permeability of the reservoir, whereas cumulative production increase due to laterals does depend on it.

As stated in section 4.1, several authors report on the performance improvement following a RJD stimulation for hydrocarbon wells. Abdel-Ghany et al. (2011) report on





Version 10/31/2016	Project SURE - Grant-Number 654662	page 44 / 55
--------------------	------------------------------------	--------------

an increased productivity after RJD stimulation of up to 173%. Although on average much lower, Elliott (2011) show data indicating a performance increase of up to 500% the production of oil from a single well. Cinelli and Kamel (2013b) evaluate the oil production from old wells. Data indicates an up to two-fold increase in performance (oil production) after the stimulation. Ragab (2013) report on a 14-73% increased flow rate and a 15-47% increase oil production rate after RJD. For an oilfield in Tarim, Teng et al. (2014) observed a 300% increase in oil production.

MND (2014) has published a report on the results from their RJD trial. The overall investment costs of the RJD operations conducted at Uhrice 62a well were recovered in approx. 44 days. Interim production results suggest that RJD may be an optimal solution for the revival of wells which simulation models have shown to be virtually depleted. The price of the operation is much less compared to other stimulation techniques.

From the data presented above, it can be concluded that an RJD operation can greatly improve the performance of hydrocarbon wells. In addition, an increased productivity was observed for several wells, indicating a potential added value for geothermal wells as well. Especially, if the geometry is optimized in heterogeneous reservoirs. Up to now, only hydrocarbon wells were analysed in literature. The added value for geothermal wells remains to be proven in field applications.

The presentation given by Well Services Group (WSG) (personal communication, van den Berg and Wesemann (2016)) demonstrates how WSG is developing a tool to eliminate the need of a work-over rig for the installation of the deflector shoe. Instead of running the deflector shoe connected to a tubing, it can be installed using slickline. The sequence of milling a hole into the casing and jetting into the formation remains the same procedure. This reduce the costs needed for the rig and make to technique more attractive to operators.

4.5 Environmental Impact

The environmental impact is considered to be small. The currently deployed technology has low foot-print of the operations and a low risk for the environment.

Foot-Print For the RJD operation a work-over rig or a crane is needed to pull the completion and to lower the deflector shoe into the well. The size of the required rig can therefore be much smaller than the rig needed for drilling the main well. In addition, the equipment needed by the service provider can be fitted on one 40 ft trailer, thereby reducing the carbon footprint of the transport compared to conventional hydraulic stimulation treatments. Typically, only a small portion of the well pad from drilling the well is required. In addition, the specially designed deflector assembly from van den Berg and Wesemann (2016) eliminates the need for a workover rig. The deflector shoe can be installed with slickline. The CT unit WSG uses has a built-in slickline drum, eliminating the need to mobilize a second unit. This leads to an even smaller foot-print and lower costs. The equipment that is used is all built in a sound-proof containers. The noise from this operation is therefore very limited and complying with regulations.



Environmental Risk The fluid volume for jetting one lateral is approximately 1 m^3 . The type of fluid needed for jetting can be freely chosen depending on the type of formation and availability. Ranging from fresh water, specially designed salt solution, formation water or acid. Due to the limited amount of water needed for jetting and the fact that high pressure is only applied at the rock face, no pressure is put on the formation. Induced seismicity can therefore be not expected. In addition, the risk for fluid spill on the surface during the operation is very limited.

4.6 Site Application - Klaipeda

4.6.1 Background

Cooperating with experts from the Petroleum Geology Investigators and the Danish Environmental Protection Agency and with funding from the Danish Kingdom the Baltic geothermal energy project was conducted. The objective of the project was to assess the possibility of geothermal energy provision in Lithuania, i.e. to use highly mineralized, low temperature geothermal fluid ($35\text{-}40^\circ\text{C}$) for space heating. Based on favourable results, the city of Klaipeda was chosen for the demonstration of geothermal energy provision in Lithuania. Hence, a demonstration plant was planned and constructed. The city of Klaipeda is located at the coast of the Baltic sea. It is the third largest city in Lithuania and the capital of Klaipeda County. The geothermal demonstration plant was built in the western part of Klaipeda city. Geologically Klaipedas area is part of the Baltic Basin, occupying the major Baltic Sea as well as the Estonian, Latvian and Lithuanian land areas. The Baltic Basin is bounded by the Fennoscandian Shield in the north and west and by the Tornquist-Tesseyre main tectonic zone in the south. Towards the east the Baltic Basin appears separated from the major Russian Platform area by a series of north-south trending elevated basement features, sometimes referred to as the Latvian-Lithuanian saddle. The main objective of geothermal installations comprises the Lower Devonian D1km (Kemeris) geological section from 963 m MSL to 1100 m MSL formation, also referred to as the aquifer zone". From the end of 1997 to the end of 1998, four wells were drilled. Two production wells (2P: $55^\circ 41'03.85''$ North $21^\circ 12'07.95''$ East and 3P: $55^\circ 40'58.30''$ North $21^\circ 12'12.40''$ East) and two injection wells (1I: $55^\circ 40'24.65''$ North $21^\circ 13'18.19''$ East and 4I: $55^\circ 39'41.46''$ North $21^\circ 13'18.70''$ East). The Klaipeda geothermal demonstration plant was finished in December 2001. After initial problems arising from gypsum precipitation in the thermal water loop, the plant was commissioned for the first time in 2004 by the JSC GEOTERMA. The production and injection after commissioning was about 450 m³/h of geothermal brine.

Since the beginning, JSC GEOTERMA was faced with a significant reduction of injectivity. To analyse the reason for the reduction, several geothermal water analysis were conducted. Based on the results, it was decided to treat the injection wells with hydrochloric acid. Consequently, several acid stimulation treatments were performed. In 2009, a side track (1I(A2)) with an inclination of 3° to 5° was drilled from the injection well 1I. The main well 1I was plugged and abandoned. Despite all these efforts, sustainable injection rates could not be maintained. In 2014 JSC GEOTERMA decided to perform



Version 10/31/2016	Project SURE - Grant-Number 654662	page 46 / 55
--------------------	------------------------------------	--------------

an RJD treatment to increase the injectivity of their geothermal wells. It was the first RJD stimulation performed in a geothermal well in Europe.

4.6.2 RJD Application

For a RJD treatment in the injection wells in Klaipeda, it was calculated that the injection surface after RJD was supposed to double or even triple the existing injection surface. The newly created injection surface, therefore, should enable to significantly increase the injectivity at the site. Based on the wells history, the injection well 1I(A2) was chosen to be the best candidate for the treatment. The main objective of RJD project was to create the highly conductive laterals perpendicular to the well 1I(a2). The duration of the project on site was planned for five working days. The channels were created in the middle of the most productive reservoir intervals in three different productive layers.

- 1st layer (1037.5 - 1040.0 m) start depth: 1039.0 ± 0.5 m
- 2nd layer (1095.0 - 1097.5 m) start depth: 1096.5 ± 0.5 m
- 3rd layer (1104.0 - 1107.5 m) start depth: 1106.0 ± 0.5 m

For each layer four lateral with a length of 40 ± 0.5 m and a separation of 45° - 50° were planned.

4.6.3 RJD Results

From the 12 laterals, nine were drilled with a length of 40.0 m, two laterals reached 35.0 m and one 28.0 m (Figure 12).

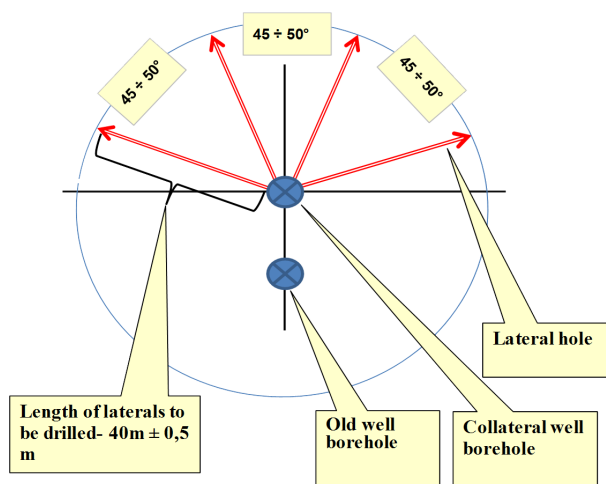

Figure 12: Scheme of laterals drilled at the Klaipeda site.

To analyse the benefit from the RJD stimulation, injection rates from before and after the operation were compared, allowing to evaluate the economic effect of the operation. The following results were obtained:





Report on Deliverable

Version 10/31/2016	Project SURE - Grant-Number 654662	page 47 / 55
--------------------	------------------------------------	--------------

- Injection rate in 2014 November-December (before shu-in): 43.1 m³/h
- Injection rate in 2015 February-March (after RJD): 49.2 m³/h
- Injection rate increase: 6.1 m³/h (14.2%)
- Provision of additional thermal energy per month: 138.0 MWh_{th}

4.6.4 Discussion

Compared to the initial assumptions, the RJD operation could not show to provide the expected significant increase in injectivity, although it is assumed that the surface area for injection was greatly increased. In an attempt to analyse reasons for this, possible processes influencing the injectivity were identified:

- Migration of micro particles;
- Hydration of clay minerals (clay swelling) was suspected initially but can be excluded based on recent core analysis;
- Clogging of laterals with micro particles generated by RJD;
- Clogging of laterals with clay minerals (reacted with minerals dissolved in the geothermal brine) deconsolidated and washed out during RJD from intersecting reservoir intervals;
- Clogging of laterals with particles from deconsolidated sand or failure of laterals in the ambient stress field;
- Clogging of laterals with precipitations;
- Geometry of laterals is different than assumed (not perpendicular to the main well for 40 m);
- The complex interplay of all above named factors.



Version 10/31/2016	Project SURE - Grant-Number 654662	page 48 / 55
--------------------	------------------------------------	--------------

5 References

References

- Abdel-Ghany, M., Siso, S., Hassan, A., Pierpaolo, P., and Roberto, C. (2011). New technology application, radial drilling petrobel, first well in egypt. In *Offshore Mediterranean Conference and Exhibition, 23-25 March, Ravenna, Italy*, number OMC-2011-163, pages –. Offshore Mediterranean Conference.
- Balch, R. (2011). Technology status assessment of field testing and diagnostics of radial-jet well- stimulation for enhanced oil recovery from marginal reserves. RPSEA Project Report.
- Balch, R. (2011-2015). Field testing and diagnostics of radial-jet well-stimulation for enhanced oil recovery from marginal reserves. Project Website.
- Balch, R. (2014). Simulation report - field testing and diagnostics of radial-jet well-stimulation for enhanced oil recovery from marginal reserves. RPSEA Project Report.
- Beckham, R. E., Shuchart, C. E., and Buechler, S. R. (2015). Impact of acid jetting on carbonate stimulation. In *International Petroleum Technology Conference, 6-9 December, Doha, Qatar*, number IPTC-18360-MS, pages –. International Petroleum Technology Conference.
- Bi, G., Li, G., Shen, Z., Huang, Z., and Yang, R. (2014). Design and rock breaking characteristic analysis of multi-jet bit on radial horizontal drilling. *UDC*.
- Bin, W., Gensheng, L., Zhongwei, H., Jingbin, L., Dongbo, Z., and Hao, L. (2016). Hydraulics calculations and field application of radial jet drilling. *SPE Drilling & Completion*, (SPE-179729-PA):–.
- Bochum, H. (2014). Geotechnical downhole high pressure abrasive drilling (geojetting). Technical report, Hochschule Bochum, Bochum. Abschlussbericht BMBF Projekt.
- Bosworth, S., El-Sayed, H. S., Ismail, G., Ohmer, H., Stracke, M., West, C., and Retnanto, A. (1998). Key issues in multilateral technology. *Oilfield Review*, 10(4):14–28.
- Brook, N. and Summers, D. (1969). The penetration of rock by high-speed water jets. *International Journal of Rock Mechanics and Mining Sciences & Geomechanics Abstracts*, 6(3):249 – 258.
- Bruni, M. A., Biasotti, J. H., and Salomone, G. D. (2007). Radial drilling in argentina. In *Latin American & Caribbean Petroleum Engineering Conference, 15-18 April, Buenos Aires, Argentina*, number SPE-107382-MS, pages –. Society of Petroleum Engineers.



Version 10/31/2016	Project SURE - Grant-Number 654662	page 49 / 55
--------------------	------------------------------------	--------------

- Buset, P., Riiber, M., and Eek, A. (2001). Jet drilling tool: Cost-effective lateral drilling technology for enhanced oil recovery. In *SPE/ICoTA Coiled Tubing Roundtable, 7-8 March, Houston, Texas*, number SPE-68504-MS, pages –. Society of Petroleum Engineers.
- Chernyshov, S. E., Galkin, S. V., Krisin, N. I., Turbakov, M. S., and Riabokon, E. P. (2015). Efficiency improvement of abrasive jet perforation. In *SPE Annual Caspian Technical Conference & Exhibition, 4-6 November, Baku, Azerbaijan*, number SPE-177375-MS, pages –. Society of Petroleum Engineers.
- Chi, H., Li, G., Huang, Z., Tian, S., and Song, X. (2015). Maximum drillable length of the radial horizontal micro-hole drilled with multiple high-pressure water jets. *Journal of Natural Gas Science and Engineering*, 26:1042 – 1049.
- Cinelli, S. D. and Kamel, A. H. (2013a). Low-cost radial jet drilling helps revitalize 40-year-old oilfield. online. (accessed April 7th, 2016).
- Cinelli, S. D. and Kamel, A. H. (2013b). Novel technique to drill horizontal laterals revitalizes aging field. In *SPE/IADC Drilling Conference, 5-7 March, Amsterdam, The Netherlands*, number SPE-163405-MS, pages –. Society of Petroleum Engineers.
- Cirigliano, R. A. and Talavera Blacutt, J. F. (2007). First experience in the application of radial perforation technology in deep wells. In *Latin American & Caribbean Petroleum Engineering Conference, 15-18 April, Buenos Aires, Argentina*, number SPE-107182-MS, pages –. Society of Petroleum Engineers.
- Dehkhoda, S. (2011). *Experimental and Numerical Study of Rock breakage by Pulsed Water Jets*. PhD thesis, University of Queensland.
- Dehkhoda, S. (2014a). Experimental study of rock breakage with pulsed water-jet. In Shimizu, Kaneko, and Kodama, editors, *Rock Mechanics for Global Issues*, pages 1469–1475. Japanese Committee for Rock Mechanics. 8th Asian Rock Mechanics Symposium.
- Dehkhoda, S. (2014b). Experimental study of rock breakage with pulsed water-jet. SUMMARY of a thesis submitted for the degree of Doctor of Philosophy at The University of Queensland in December 2011 Cooperative Research Centre for Mining (CRCMining); Nominated for ISRM Rocha Medal 2014.
- Dehkhoda, S. and Hood, M. (2013). An experimental study of surface and sub-surface damage in pulsed water-jet breakage of rocks. *International Journal of Rock Mechanics and Mining Sciences*, 63:138 – 147.
- Dehkhoda, S. and Hood, M. (2014). The internal failure of rock samples subjected to pulsed water jet impacts. *International Journal of Rock Mechanics and Mining Sciences*, 66:91 – 96.
- Deily, F. (1977). Five wells test high-pressure drilling. *Oil and Gas Journal*.





Version 10/31/2016	Project SURE - Grant-Number 654662	page 50 / 55
--------------------	------------------------------------	--------------

- Dickinson, W., Anderson, R., and Dickinson, R. (1989). The ultrashort-radius radial system. *SPE Drilling Engineering*, 4(03):-. SPE-14804-PA.
- Dickinson, W. and Dickinson, R. (1985). Horizontal radial drilling system. In *SPE California Regional Meeting, 27-29 March, Bakersfield, California*, number SPE-13949-MS.
- Dickinson, W., Dickinson, R., Herrera, A., Dykstra, H., and Nees, J. (1992a). Slim hole multiple radials drilled with coiled tubing. In *SPE Latin America Petroleum Engineering Conference, 8-11 March, Caracas, Venezuela*, number SPE-23639-MS, pages -. Society of Petroleum Engineers.
- Dickinson, W., Dykstra, H., Nees, J., and Dickinson, E. (1992b). The ultrashort radius radial system applied to thermal recovery of heavy oil. In *SPE Western Regional Meeting, 30 March-1 April, Bakersfield, California*, number SPE-24087-MS, pages -. Society of Petroleum Engineers.
- Dickinson, W., Dykstra, H., Nordlund, R., and Dickinson, W. (1993). Coiled-tubing radials placed by water-jet drilling: Field results, theory, and practice. In *SPE Annual Technical Conference and Exhibition, 3-6 October, Houston, Texas*, number SPE-26348-MS, pages -. Society of Petroleum Engineers.
- Dickinson, W., Pesavento, M. J., and Dickinson, W. R. (1990). Data acquisition, analysis, and control while drilling with horizontal water jet drilling systems. In *CIM/SPE International Technical Meeting, 10-13 June, Calgary, Alberta, Canada*, number SPE-21602-MS, page 10. Society of Petroleum Engineers.
- Dongjun, M., Gensheng, L., Zhongwei, H., Jilei, N., Cheng, H., Mingjuan, L., and Jingbin, L. (2012). A model of calculating the circulating pressure loss in coiled tubing ultrashort radius radial drilling. *Petroleum Exploration and Development*, 39(4):528 – 533.
- Dongjun, M., Gensheng, L., Zhongwei, H., Jilei, N., and Xianzhi, S. (2011). An auto-switched chaos system design and experimental study of pulsed cavitating multihole nozzle. *Procedia Engineering*, 24:454 – 458. International Conference on Advances in Engineering 2011.
- Egberts, P. J. P. and Peters, E. (2015). A fast simulation tool for evaluation of novel well stimulation techniques for tight gas reservoirs. In *EUROPEC 2015, 1-4 June, Madrid, Spain*, number SPE-174289-MS, pages -. Society of Petroleum Engineers.
- Elliott, S. (2011). Coiled-tubing method drills radial laterals to improve oil production from a depleted reservoir. *World Oil Magazine*.
- Elshahawi, H., Siso, S., Samir, M., and Safwat, M. (2001). Production enhancement in the belayim fields: Case histories. In *SPE Asia Pacific Oil and Gas Conference and Exhibition, 17-19 April, Jakarta, Indonesia*, number SPE-68688-MS, pages -. Society of Petroleum Engineers.



Version 10/31/2016	Project SURE - Grant-Number 654662	page 51 / 55
--------------------	------------------------------------	--------------

- Farmer, I. and Attewell, P. (1965). Rock penetration by high velocity water jet: A review of the general problem and an experimental study. *International Journal of Rock Mechanics and Mining Sciences & Geomechanics Abstracts*, 2(2):135 – 153.
- Feng, Y., Jianming, W., and Feihong, L. (2011). Numerical simulation of single particle acceleration process by sph coupled fem for abrasive waterjet cutting. *The International Journal of Advanced Manufacturing Technology*, 59(1):193–200.
- Finsterle, S., Zhang, Y., Pan, L., Dobson, P., and Oglesby, K. (2013). Microhole arrays for improved heat mining from enhanced geothermal systems. *Geothermics*, 47:104 – 115.
- Foldyna, J., Sitek, L., Martinec, P., Scucka, J., Jekl, P., and Mlynarczuk, M. (2005). Rock cutting by pulsing water jets. In *ISRM International Symposium - EUROCK 2005, 18-20 May, Brno, Czech Republic*, number ISRM-EUROCK-2005-021, pages –. International Society for Rock Mechanics.
- Freyer, R. and Shaoul, J. R. (2011). Laterals stimulation method. In *Brasil Offshore, 14-17 June, Maca, Brazil*, number SPE-143381-MS, pages –. Society of Petroleum Engineers.
- Gang, B., Gensheng, L., Zhonghou, S., Zhongwei, H., Dongjun, M., and Liangbin, D. (2013). Experimental research on the technology of hydra-jet sidetracking of radial micro-borehole. *Journal of Engineering Science and Technology Review*, 6(5):137–142.
- Guo, R., Li, G., Huang, Z., Tian, S., Zhang, X., and Wu, W. (2009). Theoretical and experimental study of the pulling force of jet bits in radial drilling technology. *Petroleum Science*, 6(4):395–399.
- Gupta, A. (2012). Performance optimization of abrasive fluid jet for completion and stimulation of oil and gas wells. *Journal of Energy Resources Technology*, 134(2):021001–021001.
- Hagan, P. (1992). The cuttability of rock using a high pressure water jet. In *Western Australian Conference on Mining Geomechanics*.
- Harris, H. and Mellor, M. (1974). Cutting rock with water jets. *International Journal of Rock Mechanics and Mining Sciences & Geomechanics Abstracts*, 11(9):343 – 358.
- Hood, M., Nordlund, R., and Thimons, E. (1990a). A study of rock erosion using high-pressure water jets. *International Journal of Rock Mechanics and Mining Sciences & Geomechanics Abstracts*, 27(2):77 – 86.
- Hood, M., Thimons, E. D., and Knight, G. C. (1990b). *A review of water-jet-assisted rock cutting*. Information circular / Bureau of Mines ;9273. U.S. Dept. of the Interior, Bureau of Mines, Washington, D.C. (2401 E St., N.W., Washington 20241).



Version 10/31/2016	Project SURE - Grant-Number 654662	page 52 / 55
--------------------	------------------------------------	--------------

- Huanpeng, C., Gensheng, L., Zhongwei, H., Shouceng, T., and Fei, D. (2013). Extending ability of micro-hole radial horizontal well. In *Waterjet Technology Association and Industrial & Municipal Cleaning Association*.
- Ivakhnenko, A., Seitova, N., and Dzhafarov, T. (2013). Classification of mechanical heterogeneity of petroleum reservoir rocks optimal for radial drilling technology. In *Geophysical Research Abstracts*, volume 15 of *EGU General Assembly 2013*.
- Kamel, A. H. (2014). Rjd revitalizes mature kansas oilfield. *Oil and Gas Journal*.
- Khorshidian, H., Butt, S. D., and Arvani, F. (2014). Influence of high velocity jet on drilling performance of pdc bit under pressurized condition. In *48th U.S. Rock Mechanics/Geomechanics Symposium, 1-4 June, Minneapolis, Minnesota*, number ARMA-2014-7465, pages -. American Rock Mechanics Association.
- Kohar, J. P. (2014). Radial drilling technique for improving recovery from existing oil fields. *International Journal of Scientific & Technology Research*, 3(11):159–161.
- Kolle, J. (1999). A comparison of water jet, abrasive jet and rotary diamond drilling in hard rock. Technical report, Tempres Technologies Inc.
- Kolle, J. (2009). Jet turbodrill for enhanced geothermal system development. Technical Report TR-153, Tempres.
- Kolle, J. and Theimer, K. (2005). Mechanically-assisted jet drilling system configuration and integration. Technical report, Tempres Technologies Inc.
- Kolle, J. J. (1998). Water and abrasive jetting, and mechanical techniques expedite hard rock drilling. *Oil and Gas Journal*.
- Kolle, J. J., Otta, R., and Stang, D. (1991). Laboratory and field testing of an ultra-high-pressure, jet-assisted drilling system. In *SPE/IADC Drilling Conference, 11-14 March, Amsterdam, Netherlands*, number SPE-22000-MS, pages -. Society of Petroleum Engineers.
- Kolle, J. J., Theimer, K., Theimer, T., Cox, R., and Scherschel, S. R. (2008). Coiled tubing jet drilling with a downhole pressure intensifier. In *SPE/ICoTA Coiled Tubing and Well Intervention Conference and Exhibition, 1-2 April, The Woodlands, Texas, USA*, number SPE-113725-MS, pages -. Society of Petroleum Engineers.
- Li, J., Li, G., Huang, Z., Song, X., Yang, R., and Peng, K. (2015). The self-propelled force model of a multi-orifice nozzle for radial jet drilling. *Journal of Natural Gas Science and Engineering*, 24:441 – 448.
- Li, Y., Wang, C., Shi, L., and Guo, W. (2000). Application and development of drilling and completion of the ultrashort-radius radial well by high pressure jet flow techniques. In *International Oil and Gas Conference and Exhibition in China, 7-10 November, Beijing, China*, number SPE-64756-MS, pages -. Society of Petroleum Engineers.



Version 10/31/2016	Project SURE - Grant-Number 654662	page 53 / 55
--------------------	------------------------------------	--------------

- Li, Z. (2014). Criteria for jet cavitation and cavitation jet drilling. *International Journal of Rock Mechanics and Mining Sciences*, 71:204 – 207.
- Liao, H., Li, G., Yi, C., and Niu, J. (2012). Experimental study on the effects of hydraulic confining pressure on impacting characteristics of jets. *Atomization and Sprays*, 22(3):227–238.
- Liu, S., Li, G., Shi, H., Tian, S., and Zhao, X. (2015). Application of hydraulic pulsed jet generator for rop enhancement in shale gas well. In *Offshore Mediterranean Conference and Exhibition, 25-27 March, Ravenna, Italy*, number OMC-2015-394, pages –. Offshore Mediterranean Conference.
- Lu, Y., Huang, F., Liu, X., and Ao, X. (2015). On the failure pattern of sandstone impacted by high-velocity water jet. *International Journal of Impact Engineering*, 76:67 – 74.
- Lu, Y., Tang, J., Ge, Z., Xia, B., and Liu, Y. (2013). Hard rock drilling technique with abrasive water jet assistance. *International Journal of Rock Mechanics and Mining Sciences*, 60:47–56.
- Maniam, T., Kien Ming, L., and Punniamoorthy, S. (2014). Experience and lessons learned from the jet-in and drill-ahead operation during malaysia deepwater drilling operations. In *Offshore Technology Conference-Asia, 25-28 March, Kuala Lumpur, Malaysia*, number OTC-24743-MS, pages –. Offshore Technology Conference.
- Marbun, B. T. H., Zulkhifly, S., Arliyando, L., and Putra, S. K. (2011). Review of ultrashort-radius radial system (urrs). In *International Petroleum Technology Conference, 15-17 November, Bangkok, Thailand*, number IPTC-14823-MS, pages –. International Petroleum Technology Conference.
- Maurer, W. C. (2002). Coiled-tubing high-pressure jet drilling system.
- Maurer, W. C. and Heilhecker, J. K. (1969). Hydraulic jet drilling. In *Drilling and Rock Mechanics Symposium, 14-15 January, Austin, Texas*, number SPE-2434-MS, pages –. Society of Petroleum Engineers.
- Maurer, W. C., Heilhecker, J. K., and Love, W. W. (1973). High-pressure drilling. *Journal of Petroleum Technology*, (SPE-3988-PA):–.
- McAfee, W. M., Montgomery, T. U., and Mark Franklin Alley, Nashville, T. U. (2014). System, apparatus and method for abrasive jet fluid cutting.
- McDaniel, B. and Willett, R. (2002). Stimulation techniques for low-permeability reservoirs with horizontal completions that do not have cemented casing. In *SPE Gas Technology Symposium, 30 April-2 May, Calgary, Alberta, Canada*, number SPE-75688-MS, pages –. Society of Petroleum Engineers.



Version 10/31/2016	Project SURE - Grant-Number 654662	page 54 / 55
--------------------	------------------------------------	--------------

- Minghui, W., Gensheng, L., Huaizhong, S., Shuaishuai, S., Zhaokun, L., and Yi, Z. (2016). Theories and applications of pulsed-jet drilling with mechanical specific energy. *SPE Journal*, (SPE-174550-PA):-.
- MND (2014). Mnd group employment newsletter.
- Ni, H., Wang, R., and Du, Y. (2011). Numerical simulation and experimental study on rock breaking under pulse water jet. *The Electronic Journal of Geotechnical Engineering*, 16(H):797–806.
- Ozcelik, Y. and Engin, I. C. (2012). Development of cuttability chart in abrasive water jet cutting. In *ISRM International Symposium - EUROCK 2012, 28-30 May, Stockholm, Sweden*, number ISRM-EUROCK-2012-043, pages -. International Society for Rock Mechanics.
- Peters, E., Veldkamp, J., Pluymaekers, M., and Wilschut, F. (2015). Radial drilling for dutch geothermal applications. Technical report, TNO Netherlands.
- Peters, S. (2015). Production performance of radial jet drilled laterals in tight gas reservoirs in the netherlands. Master's thesis, TU Delft.
- Pols, A. (1977a). Hard-rock jetting - 1: Tests show jet-drilling hard-rock potential. *Oil and Gas Journal*.
- Pols, A. (1977b). Hard-rock jetting conclusion: Rock-type decided jetting economics. *Oil and Gas Journal*.
- Ragab, S. A. M. (2013). Improving well productivity in an egyptian oil field using radial drilling technique. *Journal of Petroleum and Gas Engineering*, 4(5):103–117.
- Ragab, S. A. M. and Kamel, A. M. (2013). Radial drilling technique for improving well productivity in petrobel -egypt. In *North Africa Technical Conference and Exhibition, 15-17 April, Cairo, Egypt*, number SPE-164773-MS, pages -. Society of Petroleum Engineers.
- Sakaguchi, K., Y, Y., and Kizaki, A. (2003). *Numerical simulation of the water jet excavation of soft rock saturated with water*, chapter 73, pages 479–484. CRC Press.
- Sakaguchi, K., Yumoto, Y., and Kizaki, A. (2012). Numerical simulation of water jet excavation of rock using smoothed particle hydrodynamics. In *2012 ARMS7 - 7th Asian Rock Mechanics Symposium, Seoul, South Korea, October 15.19, 2012*.
- Schultz, D., Thompson, D., and Whitney, D. L. (2007). Abrasive perforating via coiled tubing revisited. In *SPE/ICoTA Coiled Tubing and Well Intervention Conference and Exhibition, 20-21 March, The Woodlands, Texas, U.S.A.*, number SPE-107050-MS, pages -. Society of Petroleum Engineers.



Version 10/31/2016	Project SURE - Grant-Number 654662	page 55 / 55
--------------------	------------------------------------	--------------

- Seywald, M. and Marschall, C. (2009). Usage of radial drilling by rag. *OIL GAS European Magazine*, 3:114–116.
- Solares, J. R., Amorocho, R., Bartko, K. M., Leising, L., Erkol, Z., Kelkar, S. K., Ramanathan, V., and Saldeev, R. (2009). Successful field trial of a novel abrasive jetting tool designed to create large diameter long cavities in the formation to enhance stimulation treatments. In *SPE/ICoTA Coiled Tubing & Well Intervention Conference and Exhibition, 31 March-1 April, The Woodlands, Texas*, number SPE-121794-MS, pages –. Society of Petroleum Engineers.
- Srikanth, D. and SreenivasaRao, M. (2014). Metal removal and kerf analysis in abrasive jet drilling of glass sheets. *Procedia Materials Science*, 6:1303–1311.
- Summers, D. A. and McGroarty, S. (1982). The mechanism, and some parameters controlling, the water jet cutting of rock. In *The 23rd U.S Symposium on Rock Mechanics (USRMS), 25-27 August, Berkeley, California*, pages –. American Rock Mechanics Association.
- Teale, R. (1965). The concept of specific energy in rock drilling. *International Journal of Rock Mechanics and Mining Sciences & Geomechanics Abstracts*, 2(1):57 – 73.
- Teng, X., Lu, Y., Li, N., Zhou, X., Wang, X., Zhang, F., Yang, P., Yang, C., Zhou, B., Jin, Y., Zhang, T., and Li, J. (2014). Radial drilling revitalizes aging field in tarim: A case study. In *SPE/ICoTA Coiled Tubing and Well Intervention Conference and Exhibition, 25-26 March, The Woodlands, Texas, USA*, number SPE-168282-MS, pages –. Society of Petroleum Engineers.
- Toma, P., Reitman, V., Coffin, P., and Dickinson, W. (1991). [9]2 long and ultrashort turning radius of horizontal wells predictions of future production based on todays experience. In *13th World Petroleum Congress, 20-25 October, Buenos Aires, Argentina*, number WPC-24148, pages –. World Petroleum Congress.
- van den Berg, S. and Wesemann, M. (2016). Radial jetting through tubing.
- Veenhuizen, S. D., Kollé, J. J., Rice, C. C., apos, and Hanlon, T. A. (1997). Ultra-high pressure jet assist of mechanical drilling. In *SPE/IADC Drilling Conference, 4-6 March, Amsterdam, Netherlands*, number SPE-37579-MS, pages –. Society of Petroleum Engineers.
- Vestavik, O., Fidtje, T., and Faure, A. (1995). Casing window milling with abrasive fluid jet. In *SPE Annual Technical Conference and Exhibition, 22-25 October, Dallas, Texas*, number SPE-30453-MS, pages –. Society of Petroleum Engineers.
- Zhang, S., Tao, X., Lu, J., Wang, X., and Zeng, Z. (2015). Structure optimization and numerical simulation of nozzle for high pressure water jetting. *Advances in Materials Science and Engineering*, 2015:8.

