



Originally published as:

Lienen, T., Kleyböcker, A., Verstraete, W., Würdemann, H. (2014): Moderate temperature increase leads to disintegration of floating sludge and lower abundance of the filamentous bacterium *Microthrix parvicella* in anaerobic digesters. - *Water Research*, 65, pp. 203—212.

DOI: <http://doi.org/10.1016/j.watres.2014.07.019>

**Moderate temperature increase leads to disintegration of floating sludge and lower abundance of the filamentous bacterium *Microthrix parvicella* in anaerobic digesters**

T. Lienen<sup>a</sup>, A. Kleyböcker<sup>a</sup>, W. Verstraete<sup>b</sup>, H. Würdemann<sup>a\*</sup>

<sup>a</sup>GFZ German Research Centre for Geosciences, Section 4.5 Geomicrobiology, 14473 Potsdam, Germany

Tobias.Lienen@gfz-potsdam.de, Anne.Kleyboecker@gfz-potsdam.de

<sup>b</sup>LabMET, Ghent University, Coupure Links 653, B-9000 Gent, Belgium

Willy.Verstraete@UGent.be

\*Corresponding author:

Hilke.Wuerdemann@gfz-potsdam.de

Phone: (0049) 331 288 1516

Fax: (0049) 331 2300662

## **Abstract**

Filamentous bacteria such as *Microthrix parvicella* can cause serious foaming and floating sludge problems in anaerobic digesters fed with sewage sludge. The sewage sludge and oil co-fermenting laboratory-scale biogas digesters in this study were fed with substrates from a foaming-prone full-scale biogas plant containing the filamentous bacterium *M. parvicella*. At 37 °C, in both pneumatically mixed digesters a highly viscous and approximately 3 cm thick floating sludge was observed. A gradual increase of the temperature from 37 °C to 56 °C led to a significant decrease in the floating sludge thickness, which correlated with a strong decrease in the abundance of *M. parvicella* in the digestate. Furthermore, the stepwise temperature increase allowed for an adaption of the microbial community and prevented process failure. The study indicates that already a moderate temperature increase from 37 °C to 41 °C might help to control the *M. parvicella* abundance in full-scale biogas plants.

## **Keywords**

Biogas digester, floating sludge, *Microthrix parvicella*, temperature increase, DGGE, qPCR

## **List of abbreviations**

DGGE, denaturing gradient gel electrophoresis; Early warning indicator; EWI; FOG, fat, oil and grease; GPR, gas production rate; PCR, polymerase chain reaction; qPCR, quantitative polymerase chain reaction; LCFA, long chain fatty acid; TS, total solids; VFA, volatile fatty acid; VS, volatile solids; WWTP, wastewater treatment plant

## 1. Introduction

The growth of filamentous bacteria in activated sludge from wastewater treatment plants (WWTPs) and the subsequent usage of the sludge as a substrate for anaerobic digestion can cause serious foaming and floating sludge problems (Westlund et al., 1998a) with enormous consequential costs (Barber, 2005). Several studies on activated sludge treatment systems have described microorganisms that affected foaming. In particular, the filamentous bacterium Candidatus *Microthrix parvicella* (Blackall et al., 1996) was found to be involved in foaming and bulking (Eikelboom, 1975, Blackbeard et al., 1986; Martins et al., 2004). *M. parvicella* was characterized as a microaerophilic bacterium with the capability to store lipids as carbon and energy source as well as to reduce exclusively nitrate to nitrite and no further (Slijkhuis et al., 1988; Tandoi et al., 1998; Nielsen et al., 2002; Muller et al., 2012). In contrast, another study has reported that *M. parvicella* was capable of performing complete denitrification (Wanner and Grau, 1988). Several countermeasures against the growth of *M. parvicella* have been tested in WWTPs whereas their use was not sufficiently evaluated in anaerobic digesters. The usage of polyaluminum chloride in activated sludge (Nielsen et al., 2005) was shown to inhibit the lipase activity and therefore the substrate uptake of *M. parvicella* was blocked. Additionally, a slight increase in the sludge loading rate (Schade and Lemmer, 2002) seemed to reduce the growth of *M. parvicella* in activated sludge. Furthermore, Schade and Lemmer (2002) recommended limiting the introduction of long-chain fatty acids (LCFAs) to reduce the advantage of *M. parvicella* due to its storage capacity for LCFA under anaerobic conditions. As a pre-treatment of the activated sludge prior to entering the anaerobic digesters, filamentous structures were successfully reduced by heating the sewage sludge to 121 °C for 60 min in an autoclave; on the other hand, enzymatic pre-treatment with the enzyme carbohydrase and a mechanical pre-treatment with a high-pressure homogenizer did not succeed in reducing the filamentous structures (Barjenbruch et al., 2003). Furthermore, the relationship between temperature and the abundance of *M. parvicella* in WWTPs has been demonstrated in a number of publications. Kumari et al. (2009) observed an increase in *M. parvicella* population in activated sludge systems during the winter and spring seasons and smaller populations in the summer. Knoop and Kunst (1998) demonstrated the elimination of *M. parvicella* filaments in activated sludge by increasing the temperature from 12 °C to 20 °C. With regard to anaerobic digestion, in a previous study we showed decreases in *M. parvicella* abundance in a full-

scale biogas plant during the summer months, whereas the high foaming potential during the winter was related to a higher abundance of *M. parvicella* as well as the introduction of fat, oil and grease (FOG) as co-substrates (Lienen et al., 2014). Furthermore, Marneri et al. (2009) observed higher destruction of the filamentous structures in anaerobic digesters under thermophilic conditions (55 °C) compared to mesophilic conditions (35 °C).

Studies in laboratory-scale experiments with anaerobically operated digesters mostly address over-acidification and the degradation of LCFAs (Sousa et al., 2008; Kleyböcker et al., 2012; Baserba et al., 2012). However, due to the difficulties to simulate exactly the conditions present in full-scale biogas plants laboratory studies concerning foaming and floating sludge in biogas digesters are still limited.

The goal of the current study was to mimic the failure of a full-scale biogas plant and to study the effect of temperature on *M. parvicella* using quantitative PCR (qPCR). The objective was to test whether an increase in temperature is an effective countermeasure against floating sludge formation in sewage sludge and oil co-fermenting biogas digesters. Microbial diversity shifts and the abundance of *M. parvicella* were related to the increase in temperature and process performance. Furthermore, an early warning indicator (EWI) representing the ratio of the concentrations of volatile fatty acids (VFA) and calcium (Ca) in the digestate, which was developed in former studies by Kleyböcker et al. (2012) to prevent overacidifications, was tested to evaluate the process performance.

## **2. Material and methods**

### **2.1 Laboratory-scale biogas digesters**

Two laboratory-scale digesters D1 and D2 (Figure 1 modified to Kleyböcker et al., 2012) operated in parallel were each charged with 23 L of digested sludge of a foaming-prone full-scale biogas plant rich in *Microthrix parvicella* (Genbank accession number KF356040), which was fed sewage sludge and fat, oil and grease (FOG) separator waste and which was formerly affected by *M. parvicella* promoted foam formation (for a detailed description, see Lienen et al., 2014). The sludge in D1 and D2 was mixed pneumatically using biogas with a flow of 150 L h<sup>-1</sup> each day for 15 min after the substrates were introduced. For biogas recirculation, a KNF N86KTE membrane pump was used. Sewage sludge (1.4 – 1.8 kg VS m<sup>-3</sup> d<sup>-1</sup>) and sunflower oil (0.9 kg VS m<sup>-3</sup> d<sup>-1</sup>) were chosen as substrates in D1 and D2. The

sewage sludge was characterized by a pH of 5 and volatile fatty acid (VFA) concentrations of 3300 mg L<sup>-1</sup> to 6500 mg L<sup>-1</sup>. The total solids (TS) values fluctuated between 38 g kg<sup>-1</sup> and 56 g kg<sup>-1</sup> and the volatile solids (VS) values varied between 32 g kg<sup>-1</sup> and 40 g kg<sup>-1</sup>. The sewage sludge was stored at 4 °C in the refrigerator until use and was heated in the microwave for approximately 5 min at 800 watt until a value of 37 °C was reached before being added. The temperature of the added sewage sludge was kept at 37 °C during the temperature increase to avoid a possible influence of excessive microwave radiation on the abundance of *M. parvicella*. Sunflower oil was chosen as the co-substrate because of its degradability to LCFAs. The digesters were heated by an electric heater around the digesters. The adaptation phase from the digester start-up until biogas formation was stable of the two digesters lasted approximately seven months. However, due to a longer adaptation phase needed for stable process performance after the start-up of the reactor D2, the operation of D2 started 6 weeks later than in D1 and it was firstly fed by oil on day 20.

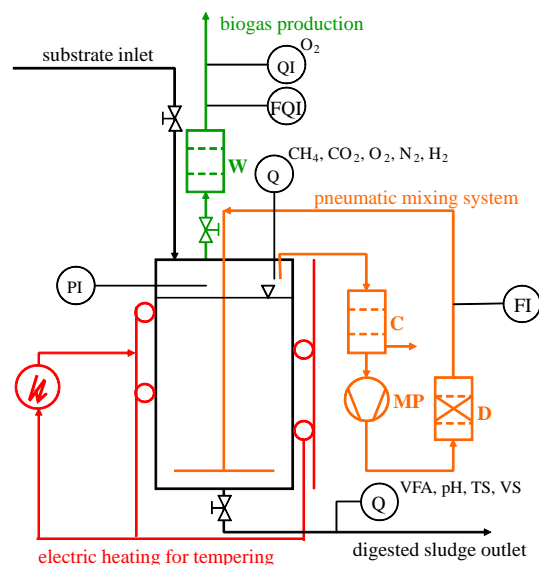

**Figure 1: Laboratory-scale reactor scheme: condensate collector (C), membrane pump (MP), drying tower (D), wash bottle (W), quality (Q, if leading letter), quantity (Q, if non-leading letter), indicating (I), flow (F), pressure (P) (modified to Kleyböcker et al., 2012).**

Floating sludge appeared in D1 and D2 at 37 °C. To avoid the growth of aerobic floating sludge forming filamentous bacteria caused by oxygen introduction, D1 and D2 were only opened at the beginning and at the end of the experiment to measure the floating sludge thickness. The oxygen levels in the biogas were

controlled by gas chromatography, and no oxygenation was detected over the experimental time. The effect of temperature on the floating sludge consistence was investigated by increasing the temperature gradually every week by 1 °C from 37 °C to 56 °C over 137 days in D1 and from 37 °C to 47 °C over 87 days in D2. Due to a technical defect, the experiment in D2 was stopped at a temperature of 47 °C. The retention time of the digested sludge was approximately 23 days.

From each digester, 1,000 mL of sludge were sampled every day from the lower outlet of the digester. For the analysis of TS and VS, the samples were dried at 105 °C for 24 h in a Memmert drying chamber and then ashed at 550 °C (Nabertherm Controller B170). The weight of the samples was determined using a Sartorius CP220S-OCE balance (scale  $\pm$  0.01 g). The TS and VS were analyzed according to the German guideline DIN 38409-1. For the VFA, calcium (Ca) and DNA extraction, the samples were centrifuged 10 min at 10,000 rpm to pellet the solid substances. The pellets were transferred into 1.5 mL tubes and stored at -20 °C until DNA extraction. The supernatant was centrifuged again for 10 min at 10,000 rpm. The VFA and Ca concentrations were quantified photometrically (Dr. Lange LCK 365 and LCK327, Hach-Lange DR2800) from the second supernatant. Furthermore, an early warning indicator (EWI) was determined in the digestates of D1 and D2 and in the floating layer of D2. The EWI is defined by the ratio of the concentration of VFA and the Ca concentration. The produced biogas volume was measured using a Ritter gas meter (TG05/5). Gas samples were taken at a bypass of the biogas pipes and analyzed by gas chromatography (SRI 8610C; SRI Instruments). The gas chromatograph was equipped with a thermal conductivity detector, a silica gel column and a 13x mol sieve column (SRI, USA). The carrier gas was argon and the analyzed gas components were hydrogen, oxygen, nitrogen, methane and carbondioxide.

## **2.2 DNA extraction**

Genomic deoxyribonucleic acid (DNA) was extracted from 350 mg of digestate from D1 and D2 using a commercial DNA isolation kit according to the manufacturer's guidelines (MP Fast DNA Spin Kit for Soil).

### 2.3 PCR-DGGE analysis

To investigate the microbial diversity during the temperature experiments three different samples from D1 of day 0 (37 °C), day 89 (47 °C) and day 137 (56 °C) were analyzed. Partial 16S rRNA genes from bacteria and methanogenic archaea were amplified by polymerase chain reaction (PCR) using the primer pair 341F-GC/907R (Muyzer et al., 1993; Amann et al., 1992) for bacteria (94 °C for 2:45 min, followed by 40 cycles of 94 °C for 0:45 min, 56 °C for 0:45 min, and 72 °C for 0:50 min, followed by 72 °C for 30 min) and the primer pair 348F-GC/786R (Sawayama et al., 2004) for the methanogenic archaea (94 °C for 2:45 min, followed by 40 cycles of 94 °C for 0:45 min, 56 °C for 0:45 min, and 72 °C for 0:50 min, followed by 72 °C for 10 min). PCR was performed in 50 µL reactions containing 5 µL of 10x buffer (Genecraft), 6 µL of dNTPs (10 mM, Fermentas), 3 µL of MgCl<sub>2</sub> (50 mM, Genecraft), 3 µL of forward primer (10 mM), 3 µL of reverse primer (10 mM), 0.4 µL of BSA (20 mg/mL, Fermentas), 0.3 µL of Taq polymerase (5 u/µL, Genecraft), 28.3 µL of RNA/DNA-free water (Fermentas) and 1 µL of 1:10 diluted template DNA. Amplicons were subsequently purified (Fermentas GeneJET PCR Purification Kit). Denaturing gradient gel electrophoresis (DGGE) was performed using equal concentrations of amplicons and a gradient of 35 % to 65 % urea and 6 % to 9 % acrylamide was used for the bacterial samples and a gradient of 40 % to 75 % urea and 6 % to 9 % acrylamide was used for the methanogenic archaea samples using the Biorad DCode System.

The DGGE gels were run for 17 hours at 110 V and 60 °C. The gel bands were excised and reamplified using the primer pairs mentioned above (94 °C for 1:30 min, followed by 30 cycles of 94 °C for 0:30 min, 56 °C for 0:30 min, 72 °C for 0:30 min, followed by 72 °C for 10 min). The PCR products were purified using the Fermentas GeneJET PCR Purification Kit. The concentrations of the amplicons were measured fluorimetrically (BMG Labtech FLUOstar OPTIMA) by labeling the DNA with Quant-iT PicoGreen (Invitrogen). The PCR products were sequenced by GATC Biotech AG. Sequence homologies were checked using BLAST (Basic Local Alignment Search Tool). Based on the DGGE profiles, a graphical representation of the bacterial community evenness was prepared using Pareto–Lorenz (PL) distribution curves as previously described by Wittebolle et al. (2008). The GelQuant.NET software, provided by biochemlabsolutions.com, was used to determine the band intensities. The band intensities for every DGGE lane were ranked from high to low, and the cumulative band intensities were used as the y-axis



values. The cumulative normalized number of bands was used as the x-axis values. Evaluation of the curves was conducted by comparing the samples to a vertical 20 % x-axis line. The theoretical perfect evenness line was set as the 45° diagonal.

## 2.4 Quantitative real-time PCR

The abundance of *M. parvicella* was determined by quantitative real-time PCR (qPCR) using the primer set S-S-M.par-0828-S-21/S-S-M.par-1018-A-17 (Kaetzke et al., 2005) for the *M. parvicella* 16S rRNA gene (95 °C for 10 min, followed by 95 °C for 15 sec, 53 °C for 20 sec, and 72 °C for 20 sec), and SYBR Green (Applied Biosystems Power SYBR Green) was used as a fluorescent dye. The amplicon length (160 bp) was checked by gel electrophoresis, and the PCR products were sequenced to confirm their identity. The amplification was carried out in 20 µL reactions containing 1 µL of 1:100 diluted extracted DNA, 10 µL of SYBR-Green (Applied Biosystems PowerSYBRGreen), 0.5 µL of forward primer (10 mM), 0.5 µL of reverse primer (10 mM), 0.5 µL of BSA (20 mg/mL Fermentas) and 7.5 µL of RNA/DNA-free water (Fermentas). Reactions were performed in triplicate. The specificity of the primer pair was checked by sequencing analysis. A standard curve using dilutions of *M. parvicella* PCR products ( $10^{-3}$  to  $10^{-9}$ ) was created for absolute quantification. Gene copy numbers of *M. parvicella* 16S rRNA were calculated relative to the standard curve and DNA concentrations using the following equation:  $\text{gene copies}/\mu\text{L} = x \text{ g}/\mu\text{L} / [160 \times 660] \times 6.022 \times 10^{23}$ . Melting curve (72 °C to 95 °C) analysis was conducted to check the specificity of the amplification. The amplification efficiency of the specific qPCR primer set was 98 % with an  $R^2$  value of 0.998. The melting curve analyses showed one specific peak at 83 °C. The number of 16S rRNA gene copies was related to g of digestate and it is further called gene copies.

## 3. Results

### *Floating sludge thickness and chemical analyses*

At 37 °C, the floating sludge in both pneumatically mixed digesters was highly viscous and approximately 3 cm thick. After increasing the temperature to 56 °C in D1, the floating sludge had completely vanished, and the thickness was below 1 mm. In D2, the thickness of the floating sludge at

47 °C was approximately 0.7 mm, which corresponded to a 75 % reduction in thickness.

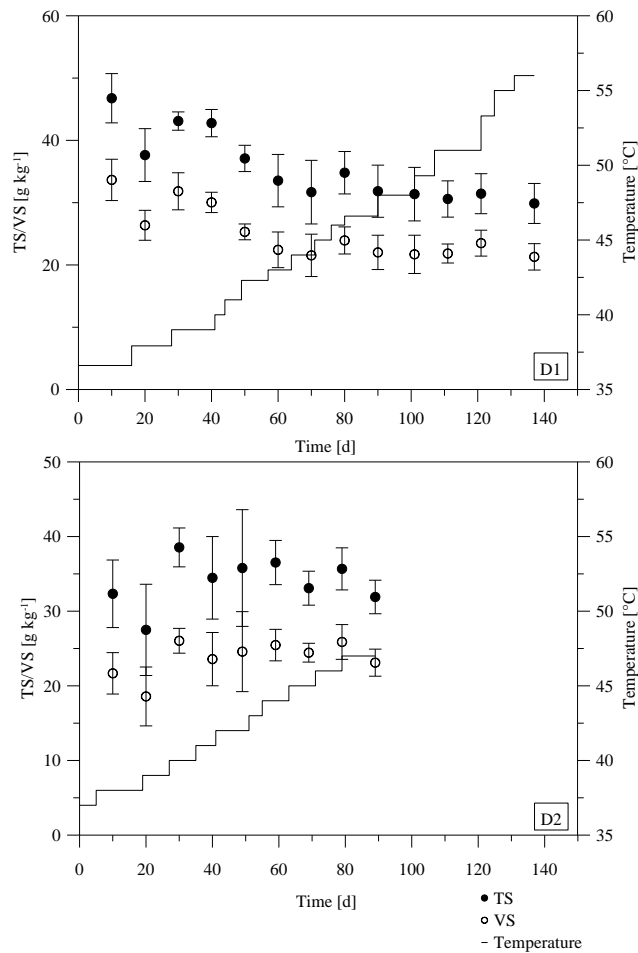

**Figure 2: Total solids (TS) and volatile solids (VS) in relation to the temperature increase over time in digesters D1 and D2. Each data point represents the average of 10 days. Decrease in TS and VS values in relation to the increase in temperature during the first 60 days in D1 and constant values afterward. TS and VS values in D2 increased after daily oil addition from day 20 on.**

The digestates of D1 were characterized by average TS values of 47 g kg<sup>-1</sup> and VS values of 34 g kg<sup>-1</sup> at 37 °C (Figure 2). After a temperature increase to 56 °C, both values decreased by 40 %. The TS and VS values of digester D2 increased after the first addition of oil from day 20 on, reaching concentrations of 38 g kg<sup>-1</sup> TS and 26 g kg<sup>-1</sup> VS (Figure 2). From 40 °C to 47 °C, TS and VS remained at 35 g kg<sup>-1</sup> and 25 g kg<sup>-1</sup>, respectively. The gas production rate (GPR) of D1 ranged from 1.7 to 2.9 L h<sup>-1</sup> during the experiment, while the GPR of D2 maintained an average of 1.0 L h<sup>-1</sup> until day 20 and it doubled after the

start of co-digestion by the daily addition of oil (Figure 3). During a slow temperature rise from 38 °C to 43 °C within 7 weeks, the VFA concentrations in D1 decreased from 1,000 mg L<sup>-1</sup> by a factor of two (Figure 3). A further temperature increase from 43 °C to 47 °C within almost 4 weeks led to an increase in VFA concentration to 800 mg L<sup>-1</sup>, ending at a concentration of 1,000 mg L<sup>-1</sup> at 56 °C. The VFA concentrations in D2 showed the same trend as D1, but the values were lower (Figure 3).

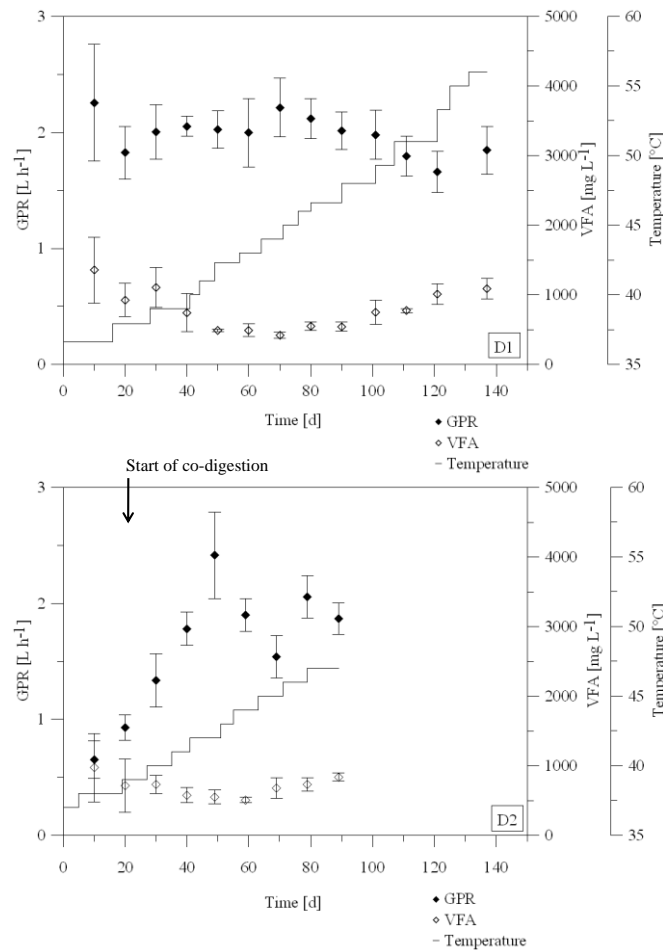

**Figure 3: Volatile fatty acids (VFA) and gas production rate (GPR) in relation to the increase in temperature in digesters D1 and D2. Each data point represents the average of 10 days. GPR in D2 increased after daily oil addition from day 20 on.**

In digester D1 at 37 °C and 38 °C, the EWI, representing the ratio of VFA and Ca concentrations, showed values up to 60 (Figure 4). While the temperature was increased from 39 °C to 49 °C, the EWI decreased by a factor of 4 and remained between 10 and 20. Above a temperature of 49 °C, the EWI

increased constantly to a final value of 60 at 56 °C. In digester D2, the EWI mainly remained in the range between 10 and 20 during the temperature increase from 37 °C to 47 °C and increased only slightly over 20 during three times. However, the EWI in the floating sludge in digester D2 was more than 10 times higher than in the digestate.

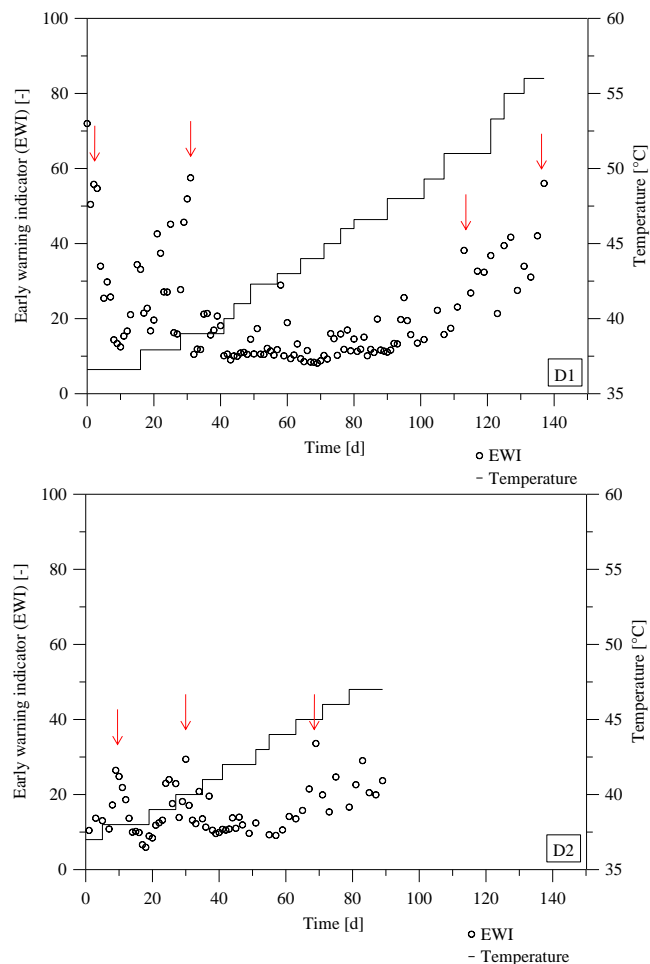

**Figure 4: Early warning indicator (EWI) during temperature increase: in digester D1, the EWI showed high values during the first 30 days and increased again starting on day 110. In digester D2, the EWI remained at a low level. Warning of the indicator is illustrated by red arrows.**

#### *Microbial community composition during the temperature increase*

Genetic fingerprinting analysis revealed differences in the DGGE band patterns but similar taxonomic bacterial groups during the temperature increase from 37 °C to 56 °C in D1 (Figure 5a). The results of sequencing of the dominant bands are summarized in table 1. The reamplification and identification of the

other bands of interest failed. Most of the detected bacterial sequences were assigned to the class *Clostridia*, belonging to the phylum *Firmicutes*. Phylogenetic affiliation of the bacterial partial 16S rRNA gene sequences showed members of the family *Syntrophomonadaceae* at 47 °C and 56 °C. A microorganism of the family *Thermotogaceae* was detected at 47 °C and 56 °C with increasing band intensity at 56 °C.

**Table 1: Sequencing of partial 16S rRNA genes retrieved from DGGE fingerprints. Taxonomic assignment was performed using NCBI's BLAST tool. n.d., not determined.**

Band ID	Closest relatives	Phylum	Genbank accession number	Similarity
1	Uncultured bacterium (KC747796.1)	n.d.	KJ561285	99%
2	Uncultured <i>Bacteroidetes</i> bacterium (AB603834.1)	<i>Bacteroidetes</i>	KJ561286	99%
3	Uncultured <i>Clostridium</i> sp. (AY330125.1)	<i>Firmicutes</i>	KJ561287	95%
4	<i>Ruminococcaceae</i> bacterium (JN656278.1)	<i>Firmicutes</i>	KJ561288	91%
5	Uncultured <i>Syntrophomonas</i> sp. (KC502886.1)	<i>Firmicutes</i>	KJ561289	96%
6	Uncultured <i>Clostridia</i> bacterium (AB669236.1)	<i>Firmicutes</i>	KJ561290	92%
7	Uncultured <i>Bacillus</i> sp. (HQ183761.1)	<i>Firmicutes</i>	KJ561291	98%
8	Uncultured bacterium (HQ453299.1)	n.d.	KJ561292	91%
9	<i>Thermotogaceae</i> bacterium (FR850164.1)	<i>Thermotogae</i>	KJ561293	99%
10	Uncultured <i>Syntrophomonadaceae</i> bacterium (JN173140.1)	<i>Firmicutes</i>	KJ561294	91%
11	<i>Coprothermobacter</i> sp. (AB630185.1)	<i>Firmicutes</i>	KJ561295	100%
12	<i>Anaerobaculum mobile</i> (CP003198.1)	<i>Synergistetes</i>	KJ561296	99%
13, 14	Uncultured <i>Methanosarcinales</i> archaeon (AB721088.1)	<i>Euryarchaeota</i>	KJ561297, KJ561298	92-93%
15	<i>Methanosarcina thermophila</i> (KC203046.1)	<i>Euryarchaeota</i>	KJ561299	96%
16, 19	<i>Methanoculleus bourgensis</i> (JN413087.1)	<i>Euryarchaeota</i>	KJ561300, KJ561303	95-99%
17	<i>Methanoculleus receptaculi</i> (NR_043961.1)	<i>Euryarchaeota</i>	KJ561301	98%
18	<i>Methanospirillum</i> sp. (AJ133792.1)	<i>Euryarchaeota</i>	KJ561302	98%
20, 21	<i>Methanosaeta concilii</i> (AB679168.1)	<i>Euryarchaeota</i>	KJ561304, KJ561305	98%

Sequences assigned to the genera *Bacillus* and *Coprothermobacter* were found at all temperatures, whereas, *Anaerobaculum mobile* was detected exclusively at 56 °C. The Pareto-Lorenz distribution pattern at the three temperatures showed similar patterns for 37 °C and 47 °C (Figure 6). The microbial community was dominated by only a few microorganisms, which accounted for more than 50 % of the community's band intensity. The distribution pattern at 56 °C showed slight differences compared to the other temperatures, indicating a more even microbial community with 40 % dominant bacteria.

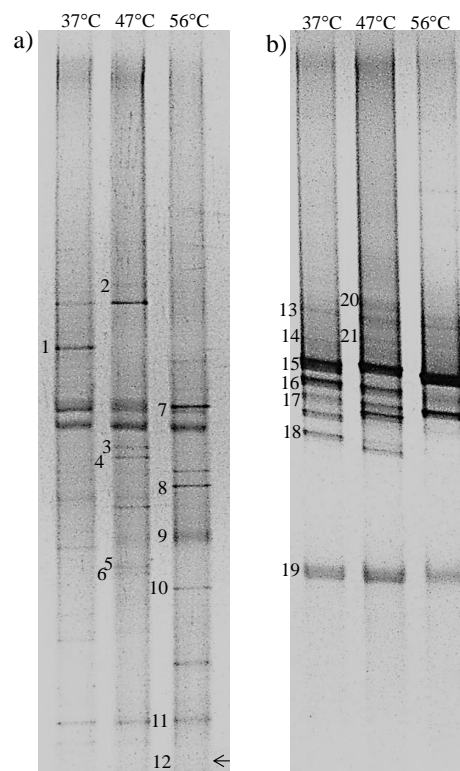

**Figure 5: D1: DGGE profiles of bacteria (a) and methanogenic archaea (b): alterations in the band pattern during the increase in temperature. Sequenced bands are labeled with numbers. The taxonomic affiliation is shown in table 1. Weak band number 12 is labeled by black arrow.**

Changes in the methanogenic community were observed exclusively at 56 °C (Figure 5b). At all temperatures, partial 16S rRNA gene sequences from acetoclastic and hydrogenotrophic methanogens were detected. The methanogens were affiliated with the acetoclastic genus *Methanosaeta*, the facultative acetoclastic genus *Methanosarcina* and the hydrogenotrophic methanogenic genera *Methanoculleus* and *Methanospirillum*. The band intensity of a *Methanoculleus bourgensis* affiliated organism became weaker

at 56 °C. Furthermore, a *Methanospirillum*-like organism was not detected at temperatures above 47 °C.

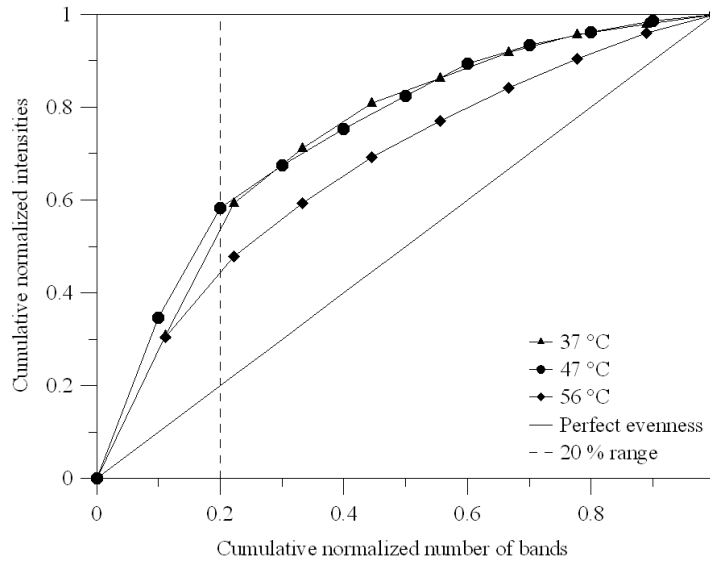

**Figure 6: D1: Pareto-Lorenz distribution curves based on bacterial DGGE profiles at 37 °C, 47 °C and 56 °C. Perfect evenness is illustrated as a straight line. The dashed vertical line was plotted to evaluate the range of the Pareto value. Similar patterns for 37 °C and 47 °C were detected, while the Pareto-Lorenz distribution showed a more even bacterial community at 56 °C.**

#### *Abundance of the filamentous M. parvicella during the temperature increase*

The absolute quantification of the filamentous bacterium *M. parvicella* by qPCR revealed significant decreases in *M. parvicella* abundance in D1 and D2 after the temperature was increased (Figure 7). In D1, the 16S rRNA gene copies amounted to approximately  $6 \times 10^5$  until the temperature was increased to 39 °C; subsequently, the gene copies decreased to half of their former level. When the temperature was increased further to 43 °C, the *M. parvicella* abundance decreased to approximately  $1 \times 10^5$  gene copies and remained at this low level till the temperature was increased onward to 56 °C. Similar to the results of D1, the *M. parvicella* 16S rRNA gene copies in D2 also strongly decreased with increasing temperatures (Figure 7). In this digester, the gene copies amounted to  $3 \times 10^6$  at day 11. After increasing the temperature to 41°C, the gene copies dropped by 80 % and remained at a level of approximately  $7 \times 10^5$  until day 87 at 47 °C.

Strong variations in *M. parvicella* abundance were detected in the fed sewage sludge, with values varying

between  $3 \times 10^5$  and  $4 \times 10^6$  16S rRNA gene copies (data not shown). The gene copies in the floating sludge of both digesters collected before the temperature increase yielded in average values of  $2 \times 10^7$  (data not shown).

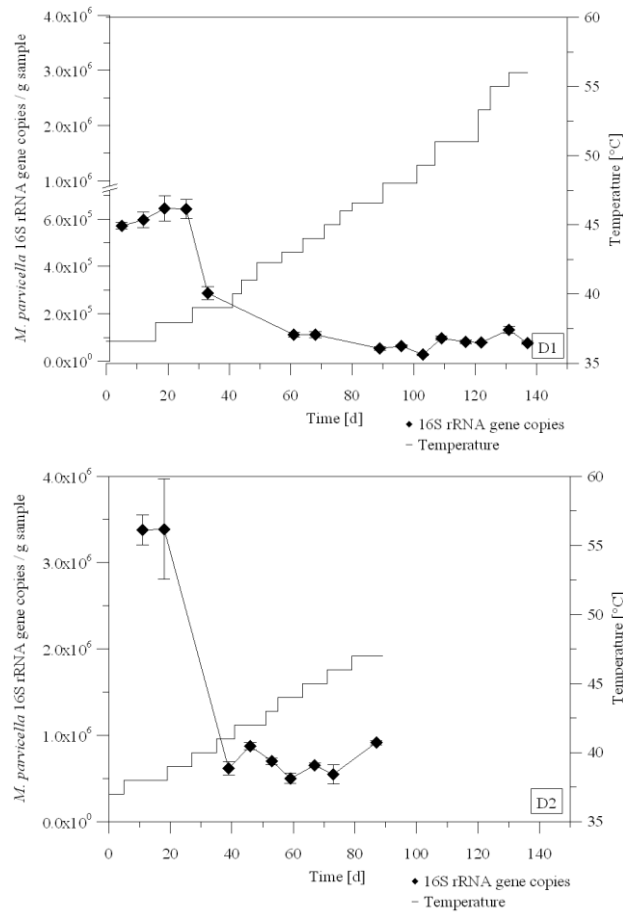

**Figure 7: Quantification of *M. parvicella* in D1 and D2 in relation to the increase in temperature. 16S rRNA gene copy number per g of digestate decreased with increasing temperatures. In D1, a 6-fold decrease was detected at 43 °C. In D2, a decrease of about 10-fold was observed once the temperature was increased to 41 °C.**

#### 4. Discussion

##### *Process performance during increase in temperature*

The effects of temperature increase on floating sludge formations were studied in laboratory-scale experiments performed over a period of 140 days in two co-fermenting biogas digesters. While D1



showed a 40 % decrease in TS and VS concentrations when the temperature increased, this was not observed in D2. The differences in the TS and VS values in both digesters were attributed to changes in the TS and VS contents in the fed sewage sludge (data not shown). The operation of D1 started six weeks before D2 was started and the TS and VS values in the fed sewage sludge were higher at this time, leading to higher concentrations in the digester. However, both digesters showed similar trends in VFA concentrations. At the beginning of the experiment, the VFA contents were high and decreased with rising temperature. Subsequently, the VFA increased again while the biogas yield was still unaffected. Most likely due to the temperature increase from mesophilic to thermophilic conditions, some of the VFA degrading microorganisms needed to adapt to the new conditions; therefore less organic acids were consumed, and the VFA concentrations increased slightly but without causing an over-acidification and breakdown of the biogas production. Moreover, the 4-fold higher values of the EWI at the beginning of the experiment in D1 indicated an imbalance in the process of biogas formation. However, from day 30 on at a temperature of 39 °C, the EWI remained at a low level indicating a stable process, even though the temperature was further increased. When the temperature exceeded 49 °C, the EWI also increased and indicated the beginning of a process imbalance. Yet, the GPR did not decrease, and the process did not fail until the end of the experiment. In experiment D2, the EWI showed only slight imbalances in the process of biogas formation, which lasted only one to three days, indicating that the process remained stable. In contrast, the value for the EWI in the floating layer was 10 times higher than in the digestate of both digesters. Since the EWI has been used up to now only to detect over-acidifications in the digestate (Kleyböcker et al., 2012), this time, it also indicated a disturbance in the floating sludge in which the VFA concentration and the calcium concentration were by a factor 4 higher and a factor 3 lower than in the digestate, respectively. Because the floating layer was on the top of the digestate, it did not interact with the digestate and the process did not cease at all. However, the high VFA content in the floating sludge was a hint that a part of the sunflower oil was held back by the floating sludge and thus was not converted to biogas efficiently.

#### *Temperature influence on changes of the microbial community*

The Pareto-Lorenz distribution pattern indicated only slight differences in the microbial community

composition at temperatures between 37 °C and 56 °C. Especially at 56 °C, a more even community structure and less dominant species were observed. In particular, members of the *Firmicutes* phylum belonging to the *Clostridiaceae* and *Syntrophomonaceae* families were detected. The high availability of oil might have promoted their presence in this study. Accordingly, Baserba et al. (2012) observed a dominance of *Firmicutes* bacteria in anaerobic digestion processes with high contents of long chain fatty acids. In addition, members of *Clostridiaceae* and *Syntrophomonaceae* were shown to be involved in the degradation of long chain fatty acids (Sousa et al., 2008). In the present study, *Coprothermobacter* and *Bacillus* were detected during the complete temperature range from 37 °C to 56 °C. In accordance, *Coprothermobacter* was shown to grow between 35 °C and 65 °C (Etchebehere et al., 1998), and the genus *Bacillus* was characterized by a temperature range from 31 °C to 76 °C (Warth, 1978). Corresponding to the findings of Menes and Muxi (2002) that determined an optimal growth temperature of 55 °C to 60 °C, an *Anaerobaculum mobile* affiliated organism was only detected at 56 °C. The dominance of *Firmicutes* bacteria is also in accordance with the results from our investigation at a full-scale biogas plant, as the digestate of this plant was used to start-up the laboratory-scale digesters studied here. Besides the phylum *Firmicutes*, the phyla *Proteobacteria* and *Actinobacteria* were additionally detected at the full-scale biogas plant (Lienen et al., 2014). Although the laboratory-scale experiments were operated with the same sludge and temperature as the full-scale biogas plant, differences between the microbial communities developed. Most likely the microbial community adapted to the different feeding and mixing conditions in the laboratory-scale digesters in the seven month period before the temperature experiment started, thus leading to the altered genetic fingerprinting pattern compared to the full-scale biogas plant. While the full-scale biogas plant was mixed using an eccentric screw pump, the laboratory-scale digester was mixed pneumatically, and different mixing conditions may have an influence on the microbial community composition. Accordingly, in another study, we observed that the microbial communities of two previous equally operated biogas reactors differed significantly after the stirring was completely disrupted in one reactor and the other reactor was only partly stirred (Lienen et al., 2013).

The methanogenic community only varied slightly over the temperature range from 37 °C to 56 °C. Moreover, the stable GPR indicated constant methanogenic activity over the temperature increase.

Apparently, the identified methanogenic members of the genera *Methanosarcina*, *Methanosaeta* and *Methanoculleus* adapted to the smooth temperature increase, while methanogens of the genus *Methanospirillum* were no longer detected at 56 °C. However, Bourque et al. (2008) observed growth of *Methanospirillum* at thermophilic temperatures. It can be speculated that in the present study the other methanogens outcompeted *Methanospirillum* at 56 °C. Furthermore, the band intensity of the *Methanoculleus bourgensis* affiliated organism decreased at 56 °C. This corresponds to the observed temperature range for optimum growth of *Methanoculleus bourgensis* between 37 °C and 45 °C (Asakawa and Nagaoka, 2003).

#### *Temperature influence on the abundance of M. parvicella*

The *M. parvicella* abundance was amounted to  $5 \times 10^5$  to  $3 \times 10^6$  gene copies by qPCR indicating a 10-100-fold lower abundance than in our previous study at the full-scale biogas plant (Lienen et al., 2014). One reason for the initially lower abundance in the laboratory-scale experiment may be the storage of the sewage sludge for one to two weeks prior to the experiment. Another reason could be that *M. parvicella* accumulated in the floating sludge, as indicated by the 10-fold higher 16S rRNA gene copy numbers. The accumulation most likely occurred because of the smooth mixing in the digester using a pneumatic device, and therefore the filamentous bacterium *M. parvicella* was enriched at the surface of the sludge, promoting the formation of floating sludge. Increasing the temperature led to a decrease of *M. parvicella*, and this correlated with a reduced floating layer. Remarkably, the presence of *M. parvicella* was already strongly repressed after a temperature increase from 37 °C to 39 °C in D1 or after an increase from 37 °C to 41 °C in D2. Our recent study in a full-scale biogas plant (Lienen et al., 2014) has shown that temperature has a significant influence on the distribution of *M. parvicella* showing a higher abundance in the winter. In pure culture studies, Slijkhuis (1983) determined an optimum temperature for *M. parvicella* of 25 °C. Another study on activated sludge systems demonstrated growth in long filaments at temperatures  $\leq 12$  °C to 15 °C, and they observed fragmentation of the *M. parvicella* filaments from a length of 300  $\mu\text{m}$  at 12 °C to a length of 30-80  $\mu\text{m}$  at 20 °C. It was assumed that, compared to the long filaments, the short filaments do not influence the sludge settleability negatively (Knoop and Kunst, 1998). However, the anaerobic system investigated here was affected by floating sludge although the

temperature was maintained at 37 °C. Obviously, the *M. parvicella* filaments were still long at this temperature, and they were only fragmented after the temperature increased further to 39 °C in D1 and to 41 °C in D2. The present study indicates that anaerobic digesters being operated at temperatures above 40 °C repress the abundance of *M. parvicella*. This is in accordance with Marneri et al. (2009) who demonstrated also the destruction of *M. parvicella* filaments under thermophilic conditions at 55 °C. Westlund et al. (1998a, 1998b), as well as Barjenbruch and Kopplow (2003), suggested heating the incoming sewage sludge for 5 min at 70 °C or 60 min at 121 °C, respectively, to prevent foaming in anaerobic digesters. Dohanyos et al. (2004) postulated that thermophilic digestion at 55 °C was more resistant to foam formation than mesophilically operated digesters. However, running the anaerobic digester thermophilically is less efficient in terms of energy consumption, whereas running the biogas plant at a constant temperature of approximately 41 °C might be more efficient.

#### *Mesophilic vs. thermophilic operation in anaerobic digesters*

The results revealed that mesophilically and thermophilically operated reactors cannot be clearly differentiated concerning the organic matter degrading microbial community. In contrast to the work of Donoso-Bravo et al. (2009), which showed that a temperature increase from 37 °C to 40 °C negatively affected acidogenesis and subsequent methanogenesis, our results indicate that a smooth transition from mesophilic operation at 37 °C to thermophilic operation at 55 °C enables a stable biogas production. Reasons might be a diverse microbial community composition with a methanogenic community that is characterized by a high temperature range. Accordingly, a gradual transition from 37 °C to 55 °C, in which only minor instabilities in volatile fatty acid accumulation were detected, was also shown in anaerobic digestion experiments with high palm oil mill effluent loading rates (Choorit and Wisarnwan, 2007). Furthermore, Boušková et al. (2005) also performed a successful stepwise transition from mesophilic (37 °C) to thermophilic (55 °C) operation in an anaerobic digester treating sewage sludge.

## **5. Conclusions**

Increasing the temperature moderately from 37 °C to 41 °C was an appropriate countermeasure against the formation of floating sludge in pneumatically mixed sewage sludge and oil co-fermenting biogas

digesters. The filamentous bacterium *Microthrix parvicella* causing foam and bulking was negatively influenced by a temperature increase of about 4 K, which resulted in a decrease in the floating sludge layer. Taken into account that most biogas plants produce excess heat when the biogas is converted into electricity, a moderate temperature increase in mesophilically operated digesters might be a promising option to prevent foam and floating sludge formation.

### **Acknowledgements**

The Authors wish to thank the German “Federal Ministry for the Environment, Nature and Nuclear Safety” for funding the project “Optgas” (FK 03KB018) and the Microbial GeoEngineering group at the GFZ in Potsdam for their valuable help in the analytical work. Willy Verstraete was supported by the MRP Biotechnology for a sustainable economy (01 MRA 510W).

### **References**

- Amann, R., Stromley, J., Devereux, R., Key, R., Stahl, D.A., 1992. Molecular and microscopic identification of sulfate-reducing bacteria in multispecies biofilms. *Applied and Environmental Microbiology* 58, 614–623.
- Asakawa, S., Nagaoka, K., 2003. *Methanoculleus bourgensis*, *Methanoculleus olentangyi* and *Methanoculleus oldenburgensis* are subjective synonyms. *International Journal of Systematic and Evolutionary Microbiology* 53 (5), 1551-1552.
- Barjenbruch, M., Kopplow, O., 2003. Enzymatic, mechanical and thermal pre-treatment of surplus sludge. *Advances in Environmental Research* 7, 715–720.
- Baserba, M.G., Angelidaki, I., Karakashev, D., 2012. Effect of continuous oleate addition on microbial communities involved in anaerobic digestion process. *Bioresource Technology* 106, 74-81.
- Blackall, L.L., Stratton, H., Bradford, D., Del Dot, T., Sjorup, C., Seviour, E.M. and Seviour, R.J., 1996. “*Candidatus Microthrix parvicella*”, a filamentous bacterium from activated sludge sewage treatment plants. *International Journal of Systematic Bacteriology* 45, 186–187.
- Blackbeard, J.R., Ekama, G.A., Marais, G.V.R., 1986. A survey of filamentous bulking and foaming in activated sludge plants in South Africa. *Water SA* 14 (1), 29–34.

- Bourque, J.S., Guiot, S.R., Tartakovsky, B., 2008. Methane Production in an UASB Reactor Operated Under Periodic Mesophilic–Thermophilic Conditions. *Biotechnology and Bioengineering* 100 (6), 1115-1121.
- Boušková, A., Dohányos, M., Schmidt, J.E., Angelidaki, I., 2005. Strategies for changing temperature from mesophilic to thermophilic conditions in anaerobic CSTR reactors treating sewage sludge. *Water Research* 39, 1481–1488.
- Choorit, W., Wisarnwan, P., 2007. Effect of temperature on the anaerobic digestion of palm oil mill effluent. *Electronic Journal of Biotechnology* 10 (3), 376-385.
- Dohanyos, M., Zabranska, J., Kutil, J., Jenicek, P., 2004. Improvement of anaerobic digestion of sludge. *Water Science and Technology* 49 (10), 89-96.
- Donoso-Bravo, A., Retamal, C., Carballa, M., Ruiz-Filippi, G., Chamy, R., 2009. Influence of temperature on the hydrolysis, acidogenesis and methanogenesis in mesophilic anaerobic digestion: parameter identification and modeling application. *Water Science and Technology* 60 (1), 9-17.
- Eikelboom, D.H., 1975. Filamentous organisms observed in activated sludge. *Water Res.* 9, 365-388.
- Etchebehere, C., Pavan, M. E., Zorzopulos, J., Soubes, M., Muxi, L., 1998. *Coprothermobacter platensis* Spm now, a new anaerobic proteolytic thermophilic bacterium isolated from an anaerobic mesophilic sludge. *International Journal of Systematic Bacteriology* 48, 1297-1304.
- Kaetzke, A., Jentsch, D., Eschrich, K., 2005. Quantification of *Microthrix parvicella* in activated sludge bacterial communities by real-time PCR. *Letters in Applied Microbiology* 40 (3), 207–211.
- Kleyböcker, A., Liebrich, M., Verstraete, W., Kraume, M., Würdemann, H., 2012. Early warning indicators for process failure due to organic overloading by rape seed oil in one-stage continuously stirred tank reactor, sewage sludge and waste digesters. *Bioresource Technology* 123, 534-541.
- Knoop, S., Kunst, S., 1998. Influence of temperature and sludge loading on activated sludge settling, especially on *Microthrix parvicella*. *Water Science and Technology* 37 (4-5), 27-35.
- Kumari, S.K.S., Marrengane, Z., Bux, F., 2009. Application of quantitative RT-PCR to determine the distribution of *Microthrix parvicella* in full-scale activated sludge treatment systems. *Applied Microbiology and Biotechnology* 83, 1135-1141.
- Lienen, T., Kleyböcker, A., Brehmer, M., Kraume, M., Moeller, L., Görsch, K., Würdemann, H., 2013.

- Floating layer formation, foaming and microbial community structure change in full-scale biogas plant due to disruption of mixing and substrate overloading. *Energy Sustainability and Society* 3, 20.
- Lienen, T., Kleyböcker, A., Verstraete, W., Würdemann, H., 2014. Foam formation in a downstream digester of a cascade running full-scale biogas plant: Influence of FOG addition and abundance of the filamentous bacterium *Microthrix parvicella*. *Bioresource Technology* 153, 1–7.
- Marneri, M., Mamais, D., Koutsouki, E., 2009. *Microthrix parvicella* and *Gordona amarae* in mesophilic and thermophilic anaerobic digestion systems. *Environ. Technol.* 30 (5), 437-444.
- Martins, A., Pagilla, K., Heijnen, J., van Loosdrecht, M., 2004. Filamentous bulking sludge-a critical review. *Water Research* 38 (4), 793–817.
- Menes, R.J., Muxi, L., 2002. *Anaerobaculum mobile* sp. nov., a novel anaerobic, moderately thermophilic, peptidefermenting bacterium that uses crotonate as an electron acceptor, and emended description of the genus *Anaerobaculum*. *International Journal of Systematic and Evolutionary Microbiology* 52, 157–164.
- Muller, E.E., Pinel, N., Gillece, J.D., Schupp, J.M., Price, L.B., Engelthaler, D.M., Levantesi, C., Tandoi, V., Luong, K., Baliga, N.S., Korlach, J., Keim, P.S., Wilmes, P., 2012. Genome sequence of "Candidatus *Microthrix parvicella*" Bio17-1, a long-chain-fatty-acid-accumulating filamentous actinobacterium from a biological wastewater treatment plant. *Journal of Bacteriology* 194 (23), 6670-6671.
- Muyzer, G., de Waal, E.C., Uitterlinden, A.G., 1993. Profiling of complex microbial populations by denaturing gradient gel electrophoresis analysis of polymerase chain reaction-amplified genes coding for 16S rRNA. *Applied and Environmental Microbiology* 59, 695–700.
- Nielsen, P.H., Roslev, P., Dueholm, T., Nielsen, J.L., 2002. *Microthrix parvicella*, a specialized lipid consumer in anaerobic and aerobic activated sludge plants. *Water Science and Technology* 46, 73–80.
- Nielsen, P.H., Kragelund, C., Nielsen, J.L., Tiro, S., Lebek, M., Rosenwinkel, K.H., Gessesse, A., 2005. Control of *Microthrix parvicella* in Activated Sludge Plants by Dosage of Polyaluminium Salts: Possible Mechanisms. *Acta hydrochimica et hydrobiologica* 33 (2005) 3, 255–261.
- Sawayama, S., Tada, C., Tsukahara, K., Yagishita, T., 2004. Effect of ammonium addition on methanogenic community in a fluidized bed anaerobic digestion. *Journal of Bioscience and*

- Bioengineering 97 (1), 65-70.
- Schade, M., Lemmer, H., 2002. Charakterisierung von Fadenbakterien zur Bekämpfung von Schaum in Belebungsbecken. Materialien Nr. 104, Bayrisches Landesamt für Wasserwirtschaft, München.
- Slijkhuis, H., 1983. *Microthrix parvicella*, a Filamentous Bacterium Isolated from Activated Sludge: Cultivation in a Chemically Defined Medium. *Applied and Environmental Microbiology* 46, 832-839.
- Slijkhuis, H., Deinema, M.H., 1988. Effect of environmental conditions on the occurrence of *Microthrix parvicella* in activated sludge. *Water Research* 22, 825–828.
- Sousa, D.Z., Pereira, M.A., Alves, J.I., Smidt, H., Stams, A.J.M., Alves, M.M., 2008. Anaerobic microbial LCFA degradation in bioreactors. *Water Science and Technology* 57 (3), 439-444.
- Tandoi, V., Rossetti, S., Blackall, L.L., Majone, M., 1998. Some physiological properties of an Italian isolate of “*Microthrix parvicella*”. *Water Science and Technology* 37, 1–8.
- Wanner, J., Grau, P., 1988. Filamentous bulking in nutrient removal activated sludge system. *Water Science and Technology* 20 (4-5), 1-8.
- Warth, A.D., 1978. Relationship between the Heat Resistance of Spores and the Optimum and Maximum Growth Temperatures of Bacillus Species. *Journal of Bacteriology* 134 (3), 699-705.
- Westlund, A.B., Hagland, E., Rothman, M., 1998a. Operational aspects on foaming in digesters caused by *Microthrix parvicella*. *Water Science and Technology* 38 (8-9), 29-34.
- Westlund, A.B., Hagland, E., Rothman, M., 1998b. Foaming in anaerobic digesters caused by *Microthrix parvicella*. *Water Science and Technology* 37 (4-5), 51-55.
- Wittebolle, L., Vervaeren, H., Verstraete, W., Boon, N., 2008. Quantifying community dynamics of nitrifiers in functionally stable reactors. *Applied and Environmental Microbiology* 74 (1), 286-293.