

KTB REPORT 95-1

**International Conference on Continental Scientific Drilling,
GFZ Potsdam, Aug. 30. – Sept. 1. 1993**
(Report of the Technical Working Group)



Compiled by
the Project Management of the Continental Deep Drilling
Programme of the Federal Republic of Germany
in the Geological Survey of Lower Saxony

J. K. Draxler, P. Kehrer, H. Rischmüller †

Compilers: Dipl. Ing. J.K. Draxler
Dr. P. Kehrer
Prof. Dr.hc. H. Rischmüller †
(† 20. April 1994)

Printed by: Wittmann & Wäsch, D-30989 Gehrden

Distribution: E. Schweitzerbart'sche Verlagsbuchhandlung

Orders: E. Schweitzerbart'sche Verlagsbuchhandlung
Johannesstr. 3A
D-70176 Stuttgart

Front Cover: Used drilling bits at the KTB location during winter
1992/93 (sizes 17 1/2", 14 3/4" and 12 1/4").
Photo by Dipl. Ing. J.K. Draxler

The compilers cannot be held responsible for the opinions given and
statements made in the articles published, the responsibility is
resting with the authors.

© Niedersächsisches Landesamt für Bodenforschung,
Hannover 1994

Reprinting, copying and translations, broadcasting, reproduction by
photomechanical or other ways as well as storage in databases -
even in parts - are subject to prior permission.

All rights are reserved.

Compilers' address:
Niedersächsisches Landesamt für Bodenforschung, P.O.B. 51 01 53
D-30631 Hannover, Germany
Phone: xx49-511-643 2675

ISSN 0939-8732
ISBN 3-928559-14-1

Foreword

Several countries have been engaged and favour basic research in geosciences with national programmes. As earth sciences and the study of the lithosphere are of global interest international cooperation and coordination of the research efforts are required. The Deep Sea Drilling Programme (DSP), ventured at the beginning of the seventies, and the Ocean Drilling Programme (ODP), started in 1983, are outstanding examples of fruitful international scientific research.

From August 30th to September 1st, 1993, approximately 250 leading scientists from 28 countries met in Potsdam, Germany, to prepare the ground for the establishment of an International Continental Deep Drilling Programme (ICDP). Taking the successful DSP/ODP as examples, the scientists agreed on the fact that geoscientific research can not be limited to drilling in the oceans, but must be complimented by activities on the continents. Emphasis was directed to efforts on international basis.

The meeting itself covered subjects of general interest on the first day and was split up in twelve groups to discuss specific themes on the basis of workshops. The conclusions drawn from each individual working group were presented to the forum on the third day.

Contributions and reports presented at the meeting and the conclusions from the groups working on geoscientific subjects have been published by the Scientific Planning Committee under the title "Scientific Rationale for Establishment on an International Program of Continental Scientific Drilling".

The reports presented and discussed during the workshop by the group dealing with drilling and in situ measurement technology have intentionally not been included in the above mentioned publication. The idea was, to make them available to the audience in form of a KTB-Report.

Unfortunately the issue of this KTB-Report has been delayed.

While working on the compilation of the report the chairman of the group Heinrich Rischmüller became ill and died on April 20th 1994.

Drilling problems, the final work for the termination of the deep borehole and the delivery with the up-dating of some of the contributions caused further delays.

To avoid further postponement or even cancellation of the KTB-Report, we have waived to edit the individual reports and present them as a compiled edition. For the reader of this report the up-dated versions of the contributions will bring additional information from the final stages of the drilling process in the KTB deep borehole, not available at the time of the meeting.

Peter Kehrer
Co-Chairman of
Working Group

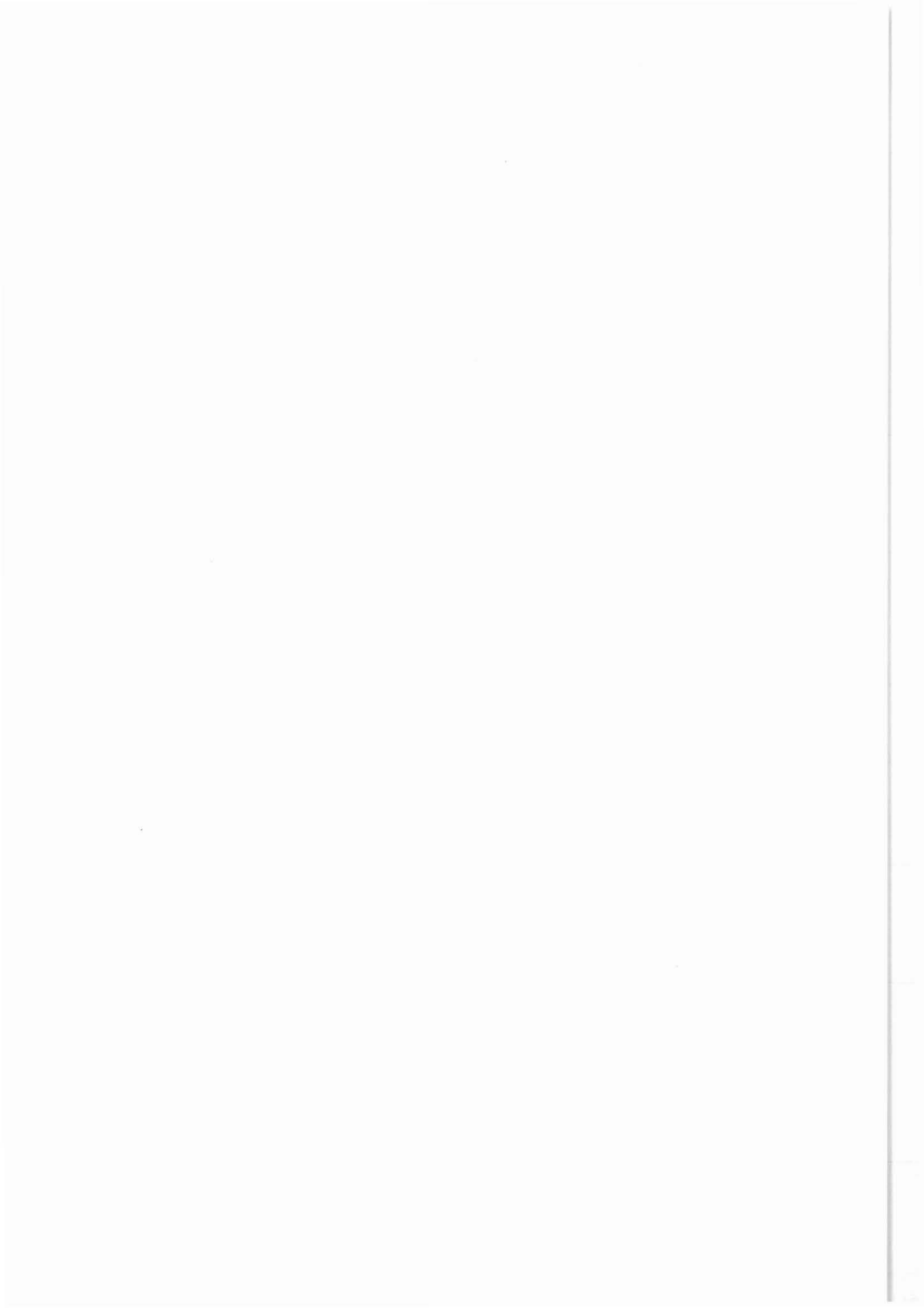

CONTENTS

	Page
Drilling, coring and sampling technology	1
H. Rischmüller, KTB, Germany Technical limits for scientific drilling and downhole measurements	5
M.A. Storms, ODP, USA Science/industry cooperation in the research & development of ODP drilling/coring technology	19
B.N. Khakhaev, NEDRA, CIS Technological problems while drilling superdeep wells	51
V.S. Basovitch, NEDRA - Kola, CIS Requirements for borehole verticality in superdeep drilling	69
S. Saito, JM&CC, Japan High temperature experiences and developments in geothermal drilling in Kakkonda, Japan	77
Liu Guangzhi, Ministry of Geology, China The strategy and concept of the proposed pilot hole drilling in China	99
A.J. Beswick, Kenting Drilling Service Ltd, UK High quality coring for scientific purposes on hard rock to 2000 m	121
Summary of deep slimhole wireline drilling in South Africa	127
J.F. Holtrop, s'Gravenhage, Netherlands Some remarks to mud technology and wellbore stability	133
J.C. Rowley, Los Alamos, USA Drilling and coring technologies for CSD products	137

H. Gloth, TU Bergakademie Freiberg, Germany Scientific drilling, sampling and testing up to 5000 m depth	151
R. Jürgens, Baker Hughes INTEQ, Germany Slim hole and horizontal drilling, - Potential for geoscientific research -	177
F. Young et al., UTB, Germany UTB: Rig layout and rig operation for ultradeep scientific drilling	187
Downhole Measurement Technology	205
C. Boyeldieu, Schlumberger, France Logging While Drilling and other new logging techno- logies, - Their potential for lithosphere research -	209
P. Kehrer, et al., KTB, Germany Subsurface data acquisition for science by downhole measurements	241
P. Lysne, Sandia NL, USA Evolution of downhole measurement systems	253
J.K. Draxler, et al., KTB, Germany Measurement systems for in situ data acquisition in normal, superdeep, slim and tough boreholes Availability of tools from industry and third parties today	263

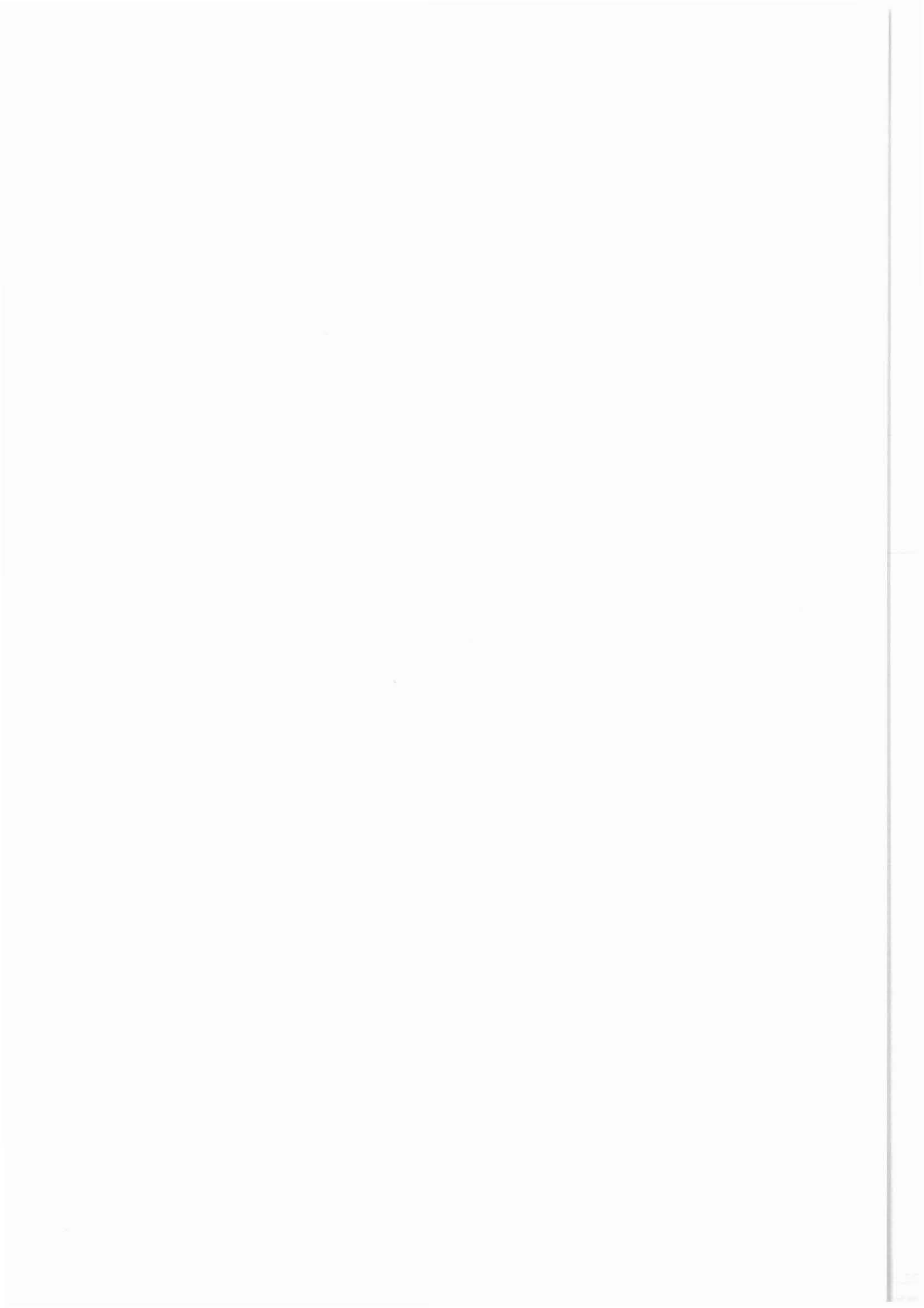

**DRILLING, CORING AND SAMPLING
TECHNOLOGY**



**Technical limits for scientific drilling and
downhole measurements**

H. Rischmüller

Geological Survey of Lower Saxony
KTB-Project Management
Stilleweg 2
30669 Hannover / Germany

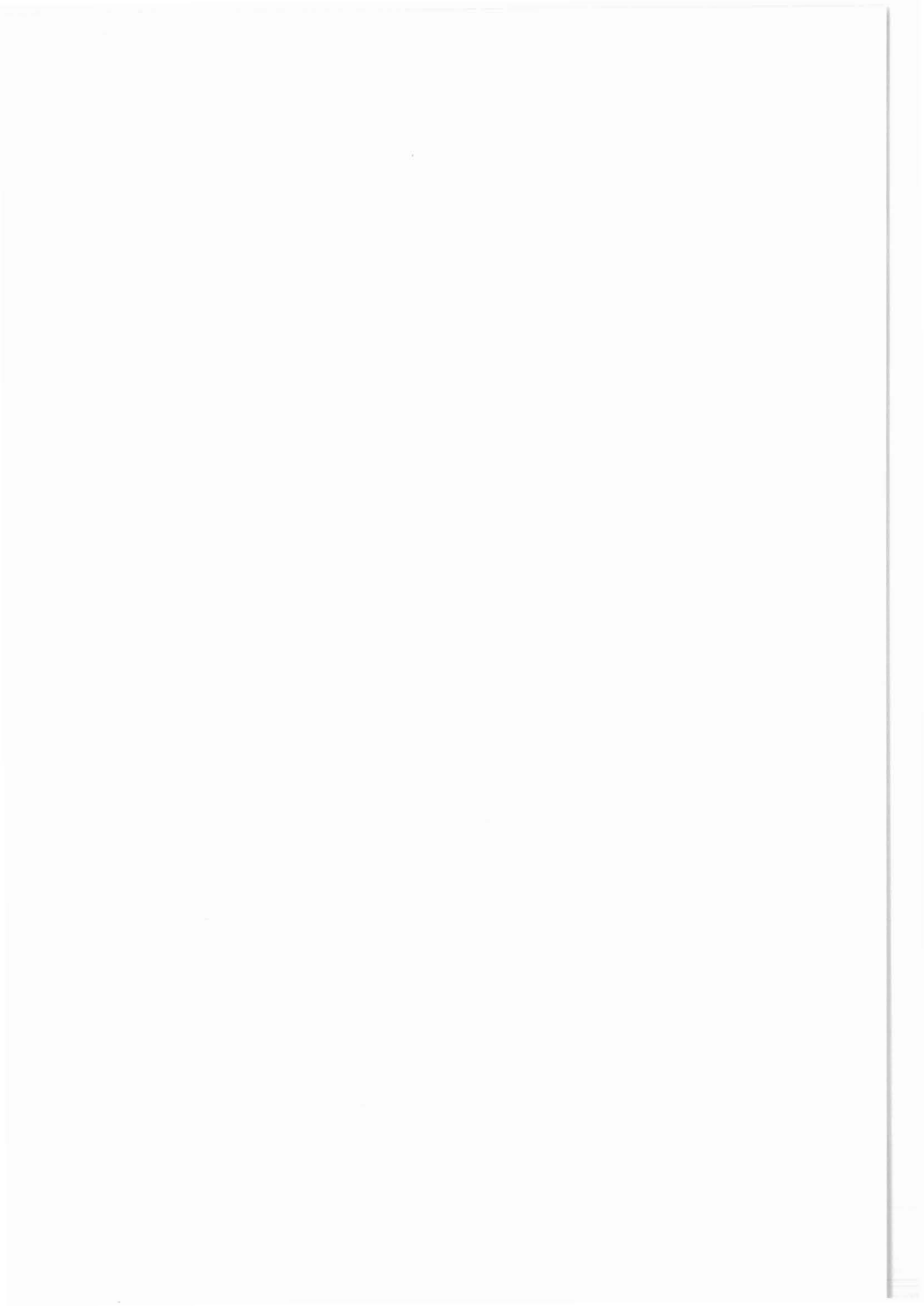

Technological limits for scientific drilling and downhole measurements

Report on the "International Conference on Continental Scientific Drilling"
(ISSD), GFZ Potsdam, Aug. 30 - Sept. 1, 1993
by
Heinrich Rischmüller

1. Introduction

Aims and objectives of ISSD-Potsdam were

- the establishment of an International Scientific Continental Drilling Program (similar to the Ocean Drilling Program),
- to define geoscientific problems to be addressed by drilling,
- to classify possible projects according to overall scientific benefits, world-wide or national interests, geographic and technological limitations and chances of operational realisation.

The conference was organized by the Coordinating Committee on Continental Drilling (CC-4), acting on behalf of the International Lithosphere Program, Chairman of the conference: Dr. K. Burke, President of ILP, Scientific Coordinator: Dr. M. Zoback, Chairman of CC-4, Sponsors: GFZ, DFG, NSF, DOE, USGS, BRGM, UNESCO, CEC, University Potsdam, Ministry of Economics Brandenburg.

Main Topics:

After the opening and several plenary presentations the conference split up into 12 working groups to discuss for 1 1/2 days the main topics. In each working group the international experts assembled to discuss the specific subjects in open sessions:

- Basin Evolution,
- Calibration of Crustal Geophysics,
- Ocean-Continent Margins and Continental Accretion,
- Earth History and Climate,
- Dynamics and Deformation of the Lithosphere,
- Volcanic Systems and Thermal Regimes,
- Crust/Mantle Transition,
- Convergent Plate Boundaries and Collision Zones,
- Fluids in the Crust of the Earth,
- Origin of Mineral Deposits,
- Impact Structures and Mass Extinctions,
- Current Drilling, Coring and Sampling Technology.

230 experts from 25 nations followed the invitation. Representatives from Australia, Austria, Belgium, Canada, China, Czeck. Rep., Denmark, Finland, France, Germany, Greece, Italy, Japan, Mexico, Netherlands, New Zealand, Russia, Slovenia, Spain,

Sweden, Switzerland, Turkey, Ukrainian Rep., United Kingdom and the United States offered their expertise during the meeting.

Final Presentations and Conclusions:

The conveners of the 12 working groups presented the results and introduced possible projects. It was stressed, that drilling is an extremely important way for obtaining in situ data from sub-surface. Shallow, intermediate, deep or super-deep projects should be drilled, if the scientific output justifies the investment. During a Managers Meeting at the KTB-location in the Oberpfalz, chaired by William S. Fyfe, IUGS, the conclusions of the conference were formulated.

The creation of an International Scientific Continental Drilling Program is strongly supported by all participants. The establishment of a working group for the development of an action plan is recommended. Scientific continental boreholes are absolutely necessary for the evolution of earth sciences. The international scientific community needs boreholes to answer fundamental scientific questions of high social and economic relevance, like:

- **Investigation of the mechanism which lead to earthquakes or volcanic eruptions,**
- **Climatic history and reasons for climatic changes on earth,**
- **Careful and economic use of potable water, minerals and energy resources,**
- **Environmental protection and safe disposal of waste,**
- **Nature of the deep biosphere.**

The comprehensive realisation of these tasks will require an all-out international program. The questions to be solved have global character and are of essential importance to the human society. The international geoscientific community needs boreholes of all different depth ranges to apply the complete array of geoscientific disciplines to solve the relevant questions. **The time is ripe to initiate an INTERNATIONAL PROGRAM.** The importance of scientific boreholes is internationally recognised. Major development projects in the world can be supported and the integration of third world countries into scientific programs facilitated.

The delegates recommend to create a planning group which can draw on support from IUGS, IUGG, and GFZ, Potsdam. The group should develop a working program, find potential sponsors and evaluate the feasibility of possible projects.

The following persons have been nominated as members of the planning group:

Rolf Emmermann	Germany
Mark Zoback	USA
Kazuo Hamada	Japan
Roye Rutland	Australia
Pierre Valla	France
Ian McGregor	USA

plus one representative each from China, Mexico and Russia. Ex-officio, one member from IUGG, IUGS, ILP and KTB. The group can be enlarged if necessary.

The main objectives of the group are

- General structure of the program management,
- Financing of the program,
- Management structure for different project levels (cost control, duration, geographic situation etc.),
- Development of program structure,
- Selection criteria for the evaluation of proposals,
- Action catalogue to promote international cooperation,
- Find ways to utilize the best technology to optimize the results,
- Establish liaison to other scientific programs like ODP, IGBP, ICL etc.

2. Technological Considerations

Historical Overview

Drilling supplies indispensable information for understanding the processes in the earth, derived from cuttings, cores, exhumed fluids, downhole geophysical measurements, surface-to-hole and hole-to-hole geophysical measurements, mud logging, geochemical analysis, hydrologic testing and hydraulic fracturing. Moreover, instrumentation such as seismometers and pressure sensors can be left in boreholes for long-term monitoring of the earth's crust. The need to continually improve the performance and the efficiency of drilling and coring operations at depth and continued improvements in measurement and instrumentation capabilities provides ongoing challenges to engineers and scientists alike.

Over the past 20 years scientists (and the funding agencies providing the research funding) have become increasingly aware of the fact that specialized drilling, coring and downhole measurement technologies are usually required for nearly any scientific drilling project. To date, there are more than 50 publications to technical topics in the ILP-CC4-conferences in Tarrytown 1984, Seeheim 1985, Mora 1987, Yaroslavl 1988, Regensburg 1990 and Paris 1992. Further efforts to be mentioned are the "Engineering Foundation Conference" 1986 in Sky Valley Resort, Georgia, some conferences and briefings organized by DOSECC and a "Deep Drilling Workshop" 1990 on behalf of ODP in College Station. A large number of reports have been published on downhole measurements, new logging tools and log evaluation in ODP- and KTB-Reports and in scientific and technical professional journals.

The major contributions to the state of the art in scientific drilling are shown in the following overview:

1. ILP - CC4 - Conferences with technological contributions

Place	Time	Number
Tarrytown	May 20 - 25, 1984	2
Seeheim	Oct. 3 - 6, 1985	9
Mora	Sept. 7 - 10, 1987	11
Yaroslavl	Aug. 23 - 29, 1988	20
Regensburg	Sept. 8 - 11, 1990	7
Paris	Apr. 7 - 10, 1992	4

2. Engineering Foundation Conference "Coring and Drilling for Ultra-Deep Scientific Targets - An Engineering Challenge", Sky Valley Resort, Dillard, Georgia, Apr. 20-25, 1986. Report compiled by Frank J. Schuh and John C. Rowley
3. Briefing Session of the NSF in Washington, Jan. 13, 1987: "Engineering Technology Requirements for Deep Scientific Drilling", Contributions from DOSECC, Terra Tek and others (KTB)
4. Survey of Robert S. Andrews, JOI, June 1990, "Recent Developments in International Scientific Drilling Programs"
5. ODP - Workshop on Deep Drilling, College Station, Sept. 26, 1990, Report from J.H. Natland, Minutes of 9th TEDCOM
6. ICCD Potsdam Aug.30 - Sept.1, 1993, WG Current technological limits for drilling, coring and downhole measurements, 16 presentations

Additionally a number of thematic workshops, national and international have been performed. These efforts must be continued, to find out the constraints, but also the challenges of technology for hopefully ongoing scientific drilling.

Drilling and Measurement Technologies

The depth ranges in scientific continental drilling may be subdivided as follows

1. Shallow drilling < 2000 m
2. Intermediate deep drilling 2000 - 5000 m
3. Deep Drilling 5000 - 8000 m
4. Ultra deep drilling 8000 - 14000 m

An overview of available drilling rig capacities shows, that in the conventional depth range down to 8,000 m a feasible arrangement of rigs is commercially available. Mining rigs and hybrid rigs are cheaper than rigs for the oil industry and are preferred for continuous coring to shallow and intermediate depth. Rigs for ultradeep targets require special design and are as a singularity very expensive. For example, for the daily operating cost of the KTB ultradeep drilling rig is equivalent to 4.3 "mining type" coring rigs with 5,000 m capacity.

Range of drilling and rigs

Dayrate

	\$	DM
Land drilling		
Rig 2,000 HP, depth range 5,000-7,000 m	13,500	(22,275)
Rig 1,500 HP, depth range 3,000-5,000 m	12,800	(21,120)
Rig 1,000 HP, maximum depth 3,000 m	11,200	(18,480)

Mining drilling

Wireline coring rig (Germany), max depth 2,000 m	(9,455)	15,600
Rig of KTB pilot hole, depth range 4,000-5,000 m	(9,286)	15,322
Ultra deep continental drilling		
UTB 1 for KTB main hole	(40,867)	67,431
Offshore drilling		
Standard and heavy duty jackups & semisubmersibles	25,000 - 60,000	(41,250 - 99,000)
ODP - Joides Resolution, former SEDCO/BP 471	57,534	(94,931)

Table 1: Dayrates of available drilling rigs

Due to the overall decline in the petroleum industry the number of drilling contractors and service companies has decreased significantly. Despite this there is still a competitive market for drilling and services, including contractors for shallow, intermediate and deep drilling and a wide range of downhole services such as:

- Directional drilling etc.
- Coring and sampling and
- Wireline logging and evaluation,
- Measurement while drilling (MWD) and logging while drilling (LWD)
- Mud logging
- Cementing, fracturing and well treatments
- Well completion and testing

For the hostile environments or great depth, four major questions have to be addressed

1. Availability of recommended technology
2. R&D needed for improvement of conventional operation (optimization)
3. R&D demand to perform a special task
4. The need for very new drilling technologies like coiled-tubing and slim hole drilling

The major components and equipment for the majority of scientific drilling projects exist and are available commercially and further development is only necessary for improvement and special applications. In many of scientific drilling projects under discussion, special attention is drawn to the need for new technologies to achieve the desired scientific objectives.

The state of the art of current drilling technologies is shown in table 2:

Drilling technique	Rotary Downhole motor Wireline coring	Slim hole drilling Horizontal drilling Coiled tubing drilling
Drilling rig	Rotary, hook load 100 - 8,000 kN Mining rigs	Hybrid rigs
Drillpipe and casing	Sizes and programs Tool joints and connections Material and handling	
Downhole motors	Positive displacement motors Turbines with or without reduction gear	
Directional drilling with MWD	Horizontal drilling Vertical drilling	Side tracking Closed loop and geosteering
Drilling fluids	Water based Oil based	Air
Drill bits and core bits	Roller cone Diamonds, PCD	Anti whirl
Coring technology	Continuous and discontinuous Wireline, counterflush	KTB and ODP coring systems Side wall coring
Downhole measurement and sampling	Logging Fluid sampling Hydraulic fracturing, microfracs	Completion Tests
Safety	Blowout prevention, lost circulation, inflow, overpressure, environment protection, disposal (Cuttings, mud etc.)	

Table 2: Current technologies, state of the art

The key issue is to choose the most feasible and economic technical concept and drilling option for each individual scientific drilling project. This means to describe and qualify the scientific targets and all the related data as qualified as possible (forecast of geology), to establish alternative technical design options including judging the risk and at the end of the procedure to come an interdisciplinary decision for the best option. After that the project can start with detailed engineering, procurement and contracting.

Key Areas in Which Technological Improvements are Needed

While most of the drilling objectives discussed in this document can be carried out using currently available technology, in many cases new technology is needed (to varying degrees) to meet the scientific objectives of these projects. For this reason, it is useful to consider in overview the general areas in which technology development must be carried out.

1. Drilling at Great Depth and High Temperature

Improved performance and efficiency in essential areas of drilling and coring technology are needed, including

- Long life bits
- Retractable bits
- Drill string design and materials
- Straight hole drilling
- Advanced pipe handling
- Measurements while drilling
- Completion technologies
- Upgrading current technology to higher temperature

2. Improved Core Recovery

Many of the problems that need to be addressed require near-continuous coring. Continued improvement of coring systems will be needed to fully realize the scientific goals of many of the projects. In some cases this is true even of relatively shallow drilling (for example, to study climate changes, where drilling requirements are not met by currently available technology).

3. Difficult and Hostile Hole Conditions

Scientists need to drill and core and make downhole measurements under often difficult circumstances. These include high pore pressure, unstable rock and poorly consolidated materials. Drilling and completion in such environment will be required to meet the objectives of several projects, with major development necessary for

- Special well design and completion
- Drilling and completion fluids
- Blow-out prevention and safe operation
- "Casing While Drilling"

4. Directional Drilling and Coring

While appreciable technological advances have been made in this area in recent years, still further advances (such as directional coring) will be needed to carry out some of the proposed projects.

- System hardware to start and guide slant holes
- Capability to re-enter deviated or horizontal holes
- Long-reach drilling, coring and completion
- Systems and technologies for downhole measurements, selective testing and isolation for hydraulic fracturing (coiled tubing)

5. Downhole Measurements, Testing and Sampling Technologies

To obtain a precise and accurate record of the drilled formations in a scientific borehole downhole measurements are essential. Discontinuous data are gained from core and cutting analysis, depending on core percentage drilled, core recovery problems, sampling frequency and mixing of cuttings due to breakout in cavings. The only high

density continuous in situ measurements are borehole logs and therefore indispensable for scientific drilling projects.

The limitations of downhole measurement, testing and sampling technologies are governed by the temperature and pressure range of the tools deployed:

< 125°C (military standard)	103.4 MPa
< 175°C (service company standard)	137.9 MPa
< 260°C (hostile environment)	172.4 MPa

Two different means to convey these tools are in use:

- logging cable for wireline logging, testing and sampling
- drill pipe for "Logging While Drilling" (LWD), drill stem testing (DST) and sampling

All standard tools have been developed by industry for the exploration and exploitation of hydrocarbon and mineral resources. Speciality tools ("Third Party Tools") have been designed and manufactured by scientific agencies, laboratories and university institutes engaged in lithosphere research.

To satisfy the requirements of scientific drilling projects, the following groups of measurements and services are available and can be contracted:

- Resistivity and/or conductivity measurements
- Acoustic and seismic recordings
- Natural or induced nuclear measurements
- Magnetic measurements
- Gravity measurements
- Temperature, pressure and flow measurements
- Borehole caliper and trajectory
- Formation and drill stem testing
- Sidewall coring
- Fluid sampling

These measurements can be recorded either in water-based or oil-based muds, in vertical, deviated and horizontal wells and in a bit size range from 5" up to 17 1/2". Certain services are available for slim boreholes with less than 5" bit size.

Critical boreholes may be best served utilizing the "Logging While Drilling" method, as data are recorded while drilling is in progress. Data with reduced sampling frequency are recorded in real time via mud pulsing and high density data are stored in a memory to be evaluated after pulling the string.

Wireline logs are recorded at a later time and need therefore be corrected for mud invasion, borehole geometry etc. Software for corrections and detailed log evaluation (lithology, stratigraphy, porosity, saturation, mineral composition) is available. Scientific drilling projects in a shallow, intermediate and deep range can draw on expertise present in the industry. For ultra deep projects in crystalline rock experience has been gained from the Kola and KTB boreholes.

Like the drilling technologies, downhole measurements need to be improved by further development in cooperation with industry:

- Drilling in formations with temperatures > 260°C (logging, testing, sampling, cables, data transmission systems)

- Projects requiring long term data recording systems (sensors, memory, transmission systems)
- Slim and tough hole projects requiring HT-equipment (logging, testing, sampling, wet connectors)
- Testing, sampling and HT-fracturing equipment (packer, fluid sampler)

Conclusions

The ultimate success of a scientific drilling project will depend on the realisation of the borehole to target depth, the condition of the borehole for safe reentry, sufficient cores, samples and downhole measurements and tests, all in good quality.

Every scientific drilling project needs the cooperation of the scientific institution in charge with the drilling and service industry, as was the case in the past. This is both to take advantage of their expertise and to make the developed technologies available for immediate use in private enterprises. But, since members for consulting and advisory bodies are no longer available from industry for honour's sake, the institutions in charge are forced to hire own qualified technical experts and to encourage engineering companies to engage in scientific drilling and subsurface technology. The basic services should be supplied by an international agency, staffed with a limited number of high quality international acknowledged experts.

OILFIELD DRILLING PRODUCT INNOVATIONS

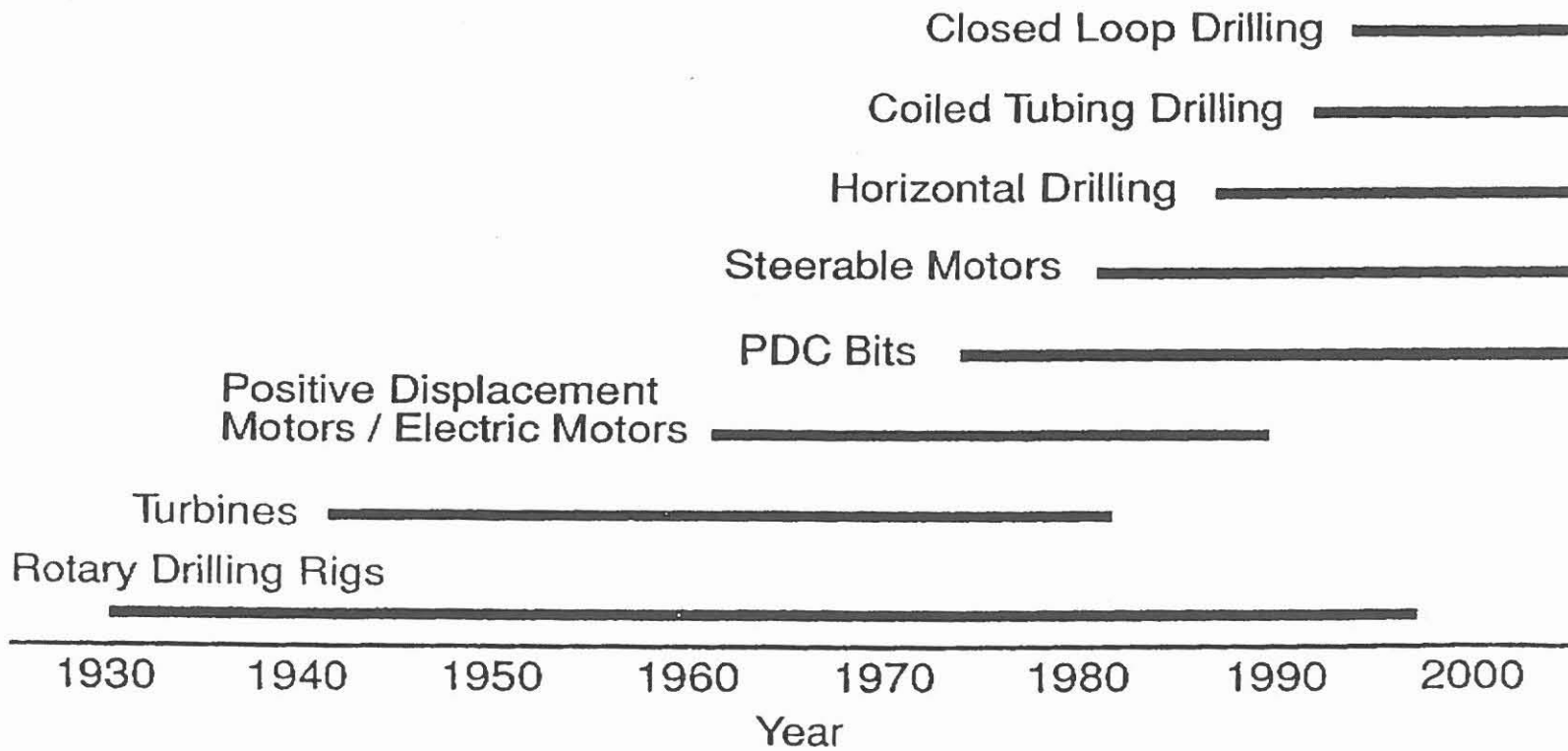

MAJOR TECHNOLOGY ACHIEVEMENTS IN DRILLING

- Navigation Drilling 1986
- Steerable Medium Radius Systems 1989
- High Torque Downhole Motors 1992
- Slim Hole Drilling (SHD) Technology 1993
- Vertical Drilling System (VDS) Commercial 1994
- Fully Steerable Medium Radius Motors (30°/100 ft) 1993
- MWD Motor Integration 1994
- Automated Drilling System 1995

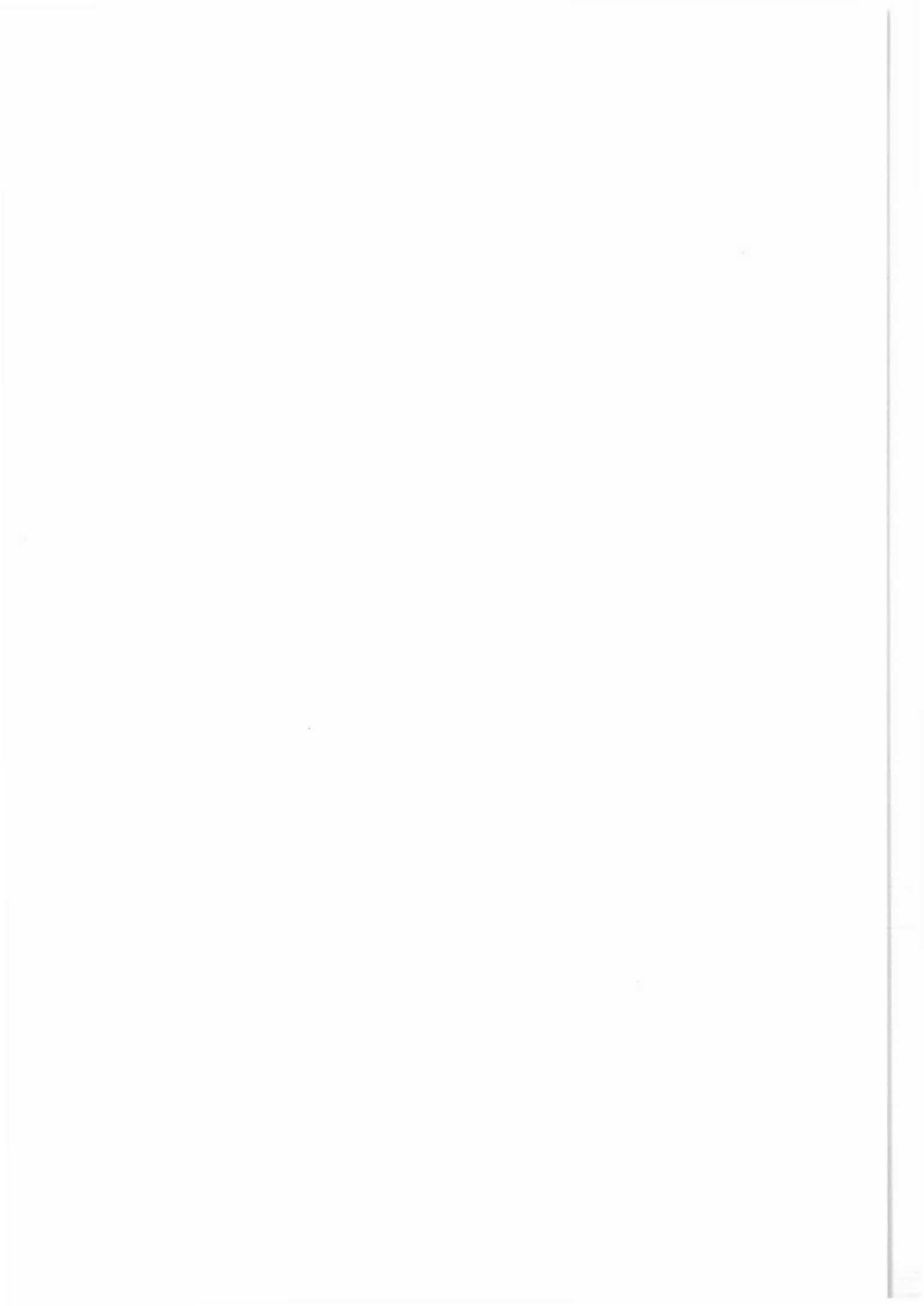

**Science/industry cooperation in the research & development
of ODP drilling/coring technology**

M. A. Storms

Ocean Drilling Program
Texas A & M University
1000 Discovery Drive
College Station, TX 77845 / USA



SCIENCE/INDUSTRY COOPERATION IN THE RESEARCH & DEVELOPMENT OF ODP DRILLING/CORING TECHNOLOGY

M. A. Storms
Assistant Manager, Engineering & Drilling Operations
Ocean Drilling Program

ABSTRACT

The Ocean Drilling Program (ODP), and the predecessor Deep Sea Drilling Project (DSDP) has established a legacy over the past two decades of developing state-of-the-art drilling and coring technology to satisfy increasingly more difficult scientific mandates. Success has been accomplished through the efforts of an outstanding technical staff working closely with geo-scientists around the world. In addition, ODP engineers have cultivated a close working relationship with industry in both the mining and petroleum sectors. The ability of any scientific research program to work closely with outside industry while maintaining good communication between an experienced technical staff and the appropriate knowledgeable scientific expertise is paramount to the success of the research effort. The ODP has demonstrated the value of these relations throughout it's reign as one of the most highly regarded international scientific research programs of it's kind. This paper will briefly define the operational capabilities and deep water drilling systems in use aboard the scientific drillship, JOIDES Resolution (SEDCO/BP 471). Technical design criteria associated with the deep water drill string and other critical operational systems will be discussed. Finally, some of the technology developed by ODP that may have applicability to an International Continental Scientific Drilling (ICSD) effort will be explored. Particular attention will be paid to those tools developed in conjunction with industry support.

INTRODUCTION

The Ocean drilling Program (ODP) sponsors an international partnership of scientists and governments to learn more about Earth's origin and evolution. Scientists sail the world's oceans in a continuous series of cruises, each approximately eight weeks long, on board the drill ship JOIDES Resolution.

During the cruises, scientists retrieve cores approximately 9.5 meters (31 feet) long -- of sediment and rock, which contain the clues to Earth's origin, evolution and present-day structure.

Scientists examine the cores to learn about Earth's processes including rearrangement of continents, evolution of life in the sea, and changes through time in global climate, ocean currents, worldwide sea level and earth's magnetic field.

Facts about the Ocean Drilling Program

ODP Legs 100-150

Deepest Penetration	2,111.0 m
	Leg 148: Hole 504B
Most Core Recovered	5,537 m
	Leg 138: Eastern Equatorial Pacific
Total Distance Traveled	167, 047 nm
Total Core Recovered	82,694 m
Total Number of Sites Visited	293
Total Number of Holes Drilled	719

A MANDATE FOR TECHNOLOGY

The ODP began its eighth year of operations in 1992; its predecessor, the Deep Sea Drilling Project, operated from 1968 to 1983. More than 20 years of drilling have enabled scientists to greatly advance what we know about the fundamental processes of planet Earth. Achievements in ocean drilling have been possible by coupling

scientific vision with technological innovations. And yet, a variety of geologic formations remains off limits because ODP has not developed the means to overcome certain technical obstacles. Until these challenging formations are conquered, scientists will not have all the pieces of Earth's geologic puzzle.

In the summer of 1987, 340 scientists from 20 countries met in Strasbourg, France, to determine how the Ocean Drilling Program could continue solving the most significant problems in oceanic earth sciences.

Our environment, the scientists noted, depends on a complex, interactive system in which the biosphere, atmosphere, oceans, crust and mantle are inextricably linked. In the late 20th century, it has become imperative that we understand how the evolution of these systems progressively modifies our environment.

In response to scientific demand, ODP is currently developing new technology

- to drill in highly fractured formations, which historically have had poor hole stability and low rates of core recovery
- to recover all types of sediments, including alternating hard-and-soft lithologies and unconsolidated sands
- to withstand the extremely high temperatures in areas where material from deep within Earth spews onto the seafloor
- to place earthquake monitoring devices and other instruments in holes for long-term data monitoring
- to drill deeper into the crust than ever before.

ODP now dedicates an average of one leg out of nine to testing newly developed engineering systems.

JOIDES RESOLUTION

Investigating Earth's origin and evolution through scientific ocean drilling would not be possible without a uniquely outfitted ship.

JOIDES Resolution, officially registered as Sedco/BP 471, is one of the top-rated drill ships in the world. Its unique features include a computer-controlled positioning system that maintains the ship over a specific location while drilling in water depths up to 27,000 feet. The ship is capable of suspending as much as 30,000 feet of drill pipe from a 400 ton heave compensation system. Additional characteristics of the drill ship are listed below:

DIMENSIONS AND CHARACTERISTICS
JOIDES Resolution (SEDCO/BP 471)

Length	470 ft (143 m)
Beam	70 ft (21 m)
Derrick	202 ft (62 m)
Operating Draft	25 ft (8 m)
Operational Displacement	18,000 t
Installed Power	14,700 kw
Thrusters	12: 800 hp each
Speed	12 knots
Cruising Range	120 days
Fuel	1,000,000 gal
Available Shaft HP Underway	9,000 hp
Scientific and Technical Party	50
Ship's Crew	68
Laboratory Space	12,000 sq ft (1,115 sq m)
Drill String	30,000 ft (9,150 m)
Heave Compensation	400 t

ENGINEERING AND DRILLING OPERATIONS

ODP's engineering and drilling operations staff works with scientists and industry to determine the tools and methods needed to meet the program's scientific objectives. For 25 years, engineers in ocean drilling have advanced science by developing state-of-the-art drilling and coring systems and techniques. The engineers have also modified systems borrowed from both the oil field and mining industries. Many ODP innovations have in turn been adopted by industry, representing an ongoing symbiosis between the two sectors.

CURRENT CORING SYSTEMS

The TAMU engineering staff has developed tools and techniques to recover core samples from geological formations around the world. A great deal of effort has gone into the design and refinement of the program's coring systems. While most of the systems mentioned here have been operational for some time, all continue to undergo upgrades and refinements to improve efficiency and performance. The following suite of tools, for instance, are the workhorse coring systems of the program. Most ODP holes are cored with various combinations of these tools. The tools are designed to penetrate progressively into more difficult layers of ocean crust.

- The Rotary Core Barrel (RCB) currently provides the most effective and efficient means to recover core samples from hard indurated formations.

It is most often deployed when deep penetrations are required into the ocean crust (Figure 1).

- The Advanced Piston Corer (APC) recovers undisturbed core in soft ooze and sediments at the seafloor. Recovery often approaches 100 percent. The system also references the core to magnetic north and can measure temperatures in the hole. The system can usually recover core as deep as 250 meters (820 feet) below the seafloor (Figure 2).
- Deployed in a common bottom hole assembly (BHA) with the APC the Extended Core Barrel (XCB) is a rotary system that allows coring to continue in firm sediments after piston coring is no longer possible. Deployment of the XCB does not require a pipe trip or starting a new hole as it is interchangeable with the APC (Figure 3).
- The Motor-Driven Core Barrel (MDCB) extends APC/XCB holes into hard sediment and crystalline rock using slimhole diamond coring technology. Rotary torque is applied to the system using fluid pressure to drive a wireline retrievable positive displacement mud motor. Advancement of the bit/core barrel into the formation is accomplished with a hydraulic thrust unit (Figure 4).

DEVELOPING NEW SYSTEMS

The engineering staff is developing advanced systems that will allow ODP to drill into formations never drilled before. Other projects improve existing systems and are designed to reduce cost, cut drilling time, or both.

- The Diamond Coring System (DCS) applies slimhole diamond coring technology adapted from the mining industry for use from an offshore drillship. A slim string of high-strength tubing is deployed through the primary API drill string and rotated ahead of the large bit. A specially designed drilling platform rides in the derrick. The system is designed to core and recover both fractured hard-rock formations as well as alternating hard and soft formations such as chert and chalk (Figure 5).
- The Vibrocorer (VPC) uses seawater to create high-frequency vibration which reduces frictional forces along grain boundaries (liquefaction). The vibrating action helps the tool to penetrate unconsolidated sediments such as loose sand.
- The Sonic Core Monitor (SCM) records periods of no recovery during the coring process. When core recovery is less than 100 percent the monitoring system allows scientists to identify gaps in the geologic record (Figure 6 and Figure 7).

The Hard Rock Orientation (HRO) system uses carbide core scribing technology in conjunction with the SCM and Electronic Multishot Data systems to allow orientation of both rotary and extended core-barrel cores (Figure 8).

- The Extended Core Barrel /Flow Control (XCB/FC) will allow more accurate metering of circulation to the cutting shoe and thereby help reduce plugging of the cutting shoe flow ports (Figure 9).
- New and improved drilling and coring bits are being designed to extend bit life, increase core recovery, and improve the rate of penetration when drilling into massive and fractured hard-rock formations. Enhancements include "low catch" TCI roller cone bit designs. Development evaluation and testing of anti-whirl and non-anti-whirl PDC bits is also continuing.

RIG EQUIPMENT

The rig equipment aboard the JOIDES Resolution is designed for deep water operations. To efficiently support continuous coring operations, all traveling components are constructed with a minimum four inch throughbore, and the 6-sheave crown block has a unique configuration to compliment the split Dreco traveling block.

The 400 ton, 20 foot stroke, traveling block mounted heave compensator, designed and built by Western Gear, is the largest of it's kind in the world.

The drill string is rotated by a Varco electric top drive, powered by a DC traction motor, and can develop as much as 41,000 ft-lb (5670 kg-m)of torque. The rpm range is adjustable from 10 through 225. Use of a top driven system offers many advantages over traditional rotary table/kelly systems particularly for coring operations. These include the ability to drill/core with longer sections of pipe, shorter connection time, and greater flexibility in dealing with stuck pipe situations.

Two Oilwell A1700PT triplex single acting 1700 HP slush pumps provide smooth and ample circulating power for coring operations. A dual Halliburton HT-400 pumping unit with a jet mixer is used for cementing casing and plugging bore holes, as well as for high pressure/low volume hydrogeologic investigations.

Automated pipe handling systems aboard the vessel include a Varco dual elevator handling system and a Varco "bigfoot" Iron Roughneck. This equipment not only protects the high strength drill pipe from slip damage and improper make-up torque on connections, but makes the rig floor a safer working environment for the rig crew. The Western Gear automated horizontal pipe racker can accomodate the full 30,000 foot tapered ODP drill string.

DRILL STRING TECHNOLOGY

Because of the extreme deep water nature of its drilling operations the ODP uses a specially designed tapered drill string. When operations are conducted in relatively shallow water only 5 inch S-140 drill pipe is used. This pipe is designed to maintain a minimum yield strength of 140,000 PSI and has an internal ID of 4-1/8 inches through the tool joints. The pipe is equipped with 5-1/2 inch API full hole connections 7 inches in outside diameter.

When deeper water is encountered or special conditions (i.e. rough weather/sea state, potentially high over pull, deep penetration desired, etc.) the string is supplemented at the top with 5-1/2 inch S-140 drill pipe. This pipe also has a minimum yield strength of 140,000 psi but is equipped with 5-1/2 inch API internal flush tool joints that measure 7-3/4 inches outside diameter and has a wall thickness of 1/2 inch.

When conditions warrant the string is capped at the top with several "knobby" drilling joints. This pipe is manufactured by turning down drill collars to a tube OD of 5-1/2 inches by 4-1/8 inch ID. Hubs measuring 13 inches long by 8 inches OD are left every five feet. The hubs are designed to distribute bending stress as vessel motion causes the drilling tubulars to contact the guide horn assembly located in the ship's moonpool.

Drilling weight is provided with a bottom hole assembly (BHA) comprised mainly of 8-1/4 inch drill collars specially modified with a 4-1/8 inch minimum ID. Connections are 6-5/8 inch full modified with a seven inch pin length.

DRILL STRING STRESS ANALYSIS PROGRAM

ODP is developing a PC based computer program for drill string stress prediction. The program is written specifically for ODP equipment used aboard SEDCO/BP 471 in its current configuration. This includes 5 and 5 1/2 inch drill pipe, special ODP "heavy wall drill joints," casing, typical ODP bottom hole assemblies, guide bases, et cetera. The vessel is equipped with a guide horn to control roll induced bending stresses. The use of rubber drill pipe protectors enhances the effectiveness of the guide horn. Where appropriate, the program accounts for the remaining bending stresses, typically 25 to 50% of the total. The program can perform:

- Stress analysis of user defined configurations and operational conditions. stresses are calculated at all critical transitions such as crossovers and changes to rubbered pipe. The program also calculates peak loads on load bearing equipment.
- Optimization of drill string configuration for either maximum factors of safety or maximum overpull capacity. The program specifies the minimum amount of drill

pipe protectors required.

The program analyzes tensile overload (beyond simple static weight) from three different sources:

- Dynamic effects (the user specifies an overload factor), important for long deployments and/or heavy payloads in severe sea states,
- Overpull combined with torque and internal pressure (all user specified), important in moderate depths with a stuck pipe, and
- Tensile elongation caused by a stuck pipe and noncompensated vessel up heave, important for shallow sites where the drill string has very limited flexibility.

The user has control over many parameters including: types of drill pipe available with and without drill pipe protectors; water depth; depth of penetration; BHA and transition configuration; casing length and weight; drill pipe wall thickness; maximum allowable stress in each type of drill pipe; dynamic overload factor, desired capacity for overpull, torque, and pressure with a stuck pipe; maximum up heave with a stuck pipe; and maximum derrick load.

The program executes in seconds on a 486 PC whereas tedious hand calculations would take hours or even days. The fast response allows the program to be used for:

- 1) site acceptance and planning,
- 2) optimization of drill string configuration, and
- 3) on site decision making.

COOPERATIVE DEVELOPMENT PROJECTS

The Ocean Drilling Program has had great success over the years establishing a working relationship with industry. Identified below are some development projects that ODP has worked on with industry assistance.

Rotary Core Barrel

The Rotary Core Barrel or RCB is the wireline coring system used most often by the ODP for coring deep penetrations (greater than 1000 meters or 3,300 feet) or for coring significant portions of oceanic basement. This coring system has been used in the collection of scientific core samples for many years. It's history dates back to the Deep Sea Drilling Project (DSDP), which was the predecessor to ODP. In 1968, the RCB wireline coring system was the only coring

system used. The RCB was a slightly modified Hycalog oilfield wireline coring system. In spite of this long and prominent history, the RCB in use today continues to undergo refinement. One upgrade added a quick release sub resulting in quicker rig floor handling and faster turn around time for deep water continuous coring operations. Several more recent upgrades, are being evaluated in an effort to reduce core jamming and improve recovery in hard, highly-fractured, often poorly cemented crystalline rock.

One of these modifications lowers the end of the core catcher shoe into a position closer to the bit face. Another concentrates on the use of a non-rotating core catcher design. Finally, alternate inner core barrel coating materials such as chrome plating are being evaluated to reduce internal friction and help reduce the resistance force during core entry.

The RCB bits were modified with improved gage protection on the leading edges of the legs and on the upper shoulder of the wear pads. Integral wear/stabilizer pads were also designed into the bit bodies and the grease reservoir was better protected. Lastly ODP continues to evaluate and monitor progress with PDC anti-whirl techniques. This field is rapidly advancing the state-of-the-art in drilling crystalline rock using PDC technology.

The ODP has worked with several major bit manufacturers and major oilfield operators on the design and use of improved hard rock bits. These include Rock Bit Industries, Security, and AMOCO Production Company.

Extended Core Barrel/Flow Control

Since it's inception, the Achilles heel of the XCB has been plugging of the core cutting shoe flow ports. Correctly controlled or modulated circulation to the face of the cutting shoe is critical to tool performance and life. Too much flow results in washed/disturbed core and/or lost recovery. Too little flow often leads to core jamming, overheated cutting structure, and resultant cutting shoe failure. In either case, the quality and amount of recovered core is severely affected.

Keeping the flow paths in the cutting shoe open and free from debris has been a continual problem for XCB project engineers. Latest attempts to combat this problem encompass a sophisticated downhole valving arrangement referred to as the XCB "Flow Control" system or XCB/FC (Figure 7). The principle behind this concept is to maintain maximized pressure within the cutting shoe flow path. When clogging begins to occur, the valve senses the situation and directs more flow (and higher pressure) to the flow path in an attempt to clear the obstruction before it becomes worse and permanently seals the affected bit jet. When the flow path is unobstructed the valve remains uninvolved in the coring process allowing the circulation rate to be controlled from the rig floor as it is in normal coring operations. Although still developmental, this system is regarded as having a great

deal of promise and is expected to eventually become a permanent part of the ODP coring arsenal. The system is designed to be compatible with standard operational XCB core barrels, ensuring that efficient coring operations are not jeopardized during sea trials.

The XCB is a heavily used coring system and has dramatically increased the effectiveness of piston coring by allowing single bit holes, spudded with the APC, to be extended to significantly greater depths. The current XCB penetration depth record was set at 940 meters (3,000+ feet) below the seafloor on Leg 122, Hole 762C (July 1988). While the XCB does a reasonably good job recovering important scientific core samples (particularly from calcium carbonate rich sediments) it is not well suited for coring in crystalline rock such as basement volcanics. A system was needed that could effectively penetrate and recover these types of rock, yet remain fully compatible with the APC/XCB BHA.

Motor Driven Core Barrel

To satisfy the problem of successfully continuing single bit APC/XCB boreholes into basement rocks, the "Navi-drill Core Barrel" (NCB) development project was initiated. In addition the tool was designed to improve recovery in such formations as fractured crystalline rock, volcanic rock interbedded with sediment, and interbedded chalk/chert formations. These three situations were tested in a test program conducted at the Institute of Petroleum Engineering in Claustahl, Germany (Figures 10-12). This name was eventually changed to the more generic Motor Driven Core Barrel or MDCB title. This system utilizes a 95.3 mm (3-3/4 inch) positive-displacement mud motor (PDM) mated with a hydraulic thruster unit designed to apply weight-on-bit (WOB) and provide stroke capacity as the tool drills out through the primary bit into virgin formation. The tool is terminated with an HWD4 core barrel and can be deployed with numerous 95.3 mm (3.75 inch) bit configurations including surface set diamond, impregnated diamond, and geoset. The system is designed to recover a nominal 4.0 meter (13.25 feet) core, 57.2 mm (2.25 inches) in diameter.

During the initial development and sea trials testing of this system, one major design weakness was identified. The tool had a propensity to stall-out downhole preventing many successful core runs. The tool relied on hydraulic thrust from the thruster unit to apply weight to the diamond drill bit. It is an inherent feature of PDM motors that the pressure drop through the tool goes up as the motor meets resistance torque from the formation. In the initial NCB design, the thruster unit was located above the PDM. This geometry resulted in a WOB increase as the PDM began to torque. The opposite response would certainly be more desirable. A good analogy would be drilling with a small hand held drill motor in a shop. When the bit begins to torque, the pressure applied to the bit is generally reduced until the torquing eases and the bit resumes full RPM. Subsequent computer modelling, along with basic changes in the way the major components were

coupled, allowed the MDCB to be improved considerably. The current tool has a built-in, load reduction feature which automatically reduces WOB when PDM torque rises. The MDCB is now considered an operational tool in the ODP arsenal of coring equipment. The tool is awaiting additional at-sea deployments before any further judgement can be made as to its performance effectiveness.

The ODP worked with several entities on the MDCB development including Eastman Christensen in Celle, Germany, the Institute of Petroleum Engineering in Clausthal, Germany, and Stress Engineering Services in Houston, Texas.

Hard Rock Orientation

The Ocean Drilling Program is developing a prototype coring system to magnetically orient hard rock cores where core recovery is less than 100 percent. The Hard Rock Orientation (HRO) system consists of an ODP standard, wireline retrievable core barrel with additional, specialized hardware. This specialized hardware includes a Sonic Core Monitor tool for recording the moment when core enters the core barrel and passes through a scribing core catcher. The scribe mark on the core is then referenced to the earth's magnetic field by an electronic orientation tool.

Development of the HRO system is based on the following philosophy. For orientation purposes, hard formation coring differs from soft formation piston coring in three critical ways. Hard rock core recovery is often less than 100 percent and can be intermittent during one coring run. The hard rock core is usually comprised of several pieces of core, each of which can rotate within the core barrel following coring. And finally, drag forces from the drill string can rotate the core barrel and change its orientation while coring. The cumulative effect of these three factors can result in a core barrel partially full of several pieces of core, each with its own orientation, recovered from different intervals during the coring run. The routine method of orienting soft formation piston cores by referencing a line on the outside of the core liner to a magnetic direction prior to the core run is useless in this case. And while some commercial hardware is available to orient hard rock cores, no system exists capable of orienting cores when core recovery is less than 100 percent.

The HRO uses a core catcher with three fixed carbide knives to scribe the incoming core. One of these blades is the primary reference and is at the apex of an isosceles triangle formed with the other two. Using three blades instead of one reduces the chance of causing eccentric loading on the incoming core which could cause a core jam. There has been no noticeable increase in the number of core jams with the new catcher. This core catcher is similar to ones used in commercial core orientation systems.

A Sonic Core Monitor (SCM) system developed and built by DBS of Houston, Texas records the incoming core height over time. The SCM is a battery powered, electronic tool mounted above the core receptacle in the core barrel. An Ultrasonic transducer continuously emits signals down the core barrel which reflect off of a specially-designed target riding on top of the core. These reflections are converted into the corresponding core heights and are saved in memory. The rate of drilling penetration is recorded into an IBM-compatible surface computer during coring and the core height is uploaded to this file once the SCM is back on deck. The result is a record of penetration versus time and core-height versus time. The SCM is critical to core alignment when recovery is less than 100 percent. At present, the SCM is unique to ODP's Hard Rock Orientation System. DBS is developing a commercial version of the tool.

A battery powered, electronic probe custom designed by Tensor Inc. in Austin, Texas uses three, orthogonal flux-gate magnetometers to record the core orientation and azimuth with respect to the earth's magnetic field. A vertical reference, or inclination, is provided by accelerometers. These readings can be recorded in either a single-shot or continuous, multi-shot mode. The tool rides in a nonmagnetic pressure case and sinker bar assembly above the core barrel and within a nonmagnetic drill collar. The magnetic reference point on the Tensor tool is mechanically linked to the scribing core catcher located in the core barrel below. The Tensor probe interfaces with an IBM-compatible computer using Tensor's proprietary software. The Tensor tool replaces the standard, camera-based multishot units which proved too sensitive to drilling-induced vibration during the 1990 testing.

The HRO latch is similar to standard RCB latches in that it uses a latch finger to hold down the core barrel against the upward force from the incoming core. It also acts as a bearing to isolate the core barrel from the drill pipe rotation. Its distinctive function, however, is to maintain alignment between the sinker bar assembly containing the Tensor tool above and the core barrel with the core scribing knives below.

DIAMOND CORING SYSTEM

The Diamond Coring System or DCS is under development to improve recovery and penetration capability when coring sedimentary and crystalline rock formations in up to 4,500 meters (15,000 feet) of water.

The DCS encompasses several primary sub-systems all of which are critical to it's success as a system (Figure 13):

- Tubing/drill rod string designed for offshore deep water slimhole drilling/coring operations.

- Special slimhole diamond core bits designed for a variety of operating environments.
- Modified wireline retrievable core barrel modeled after a mining style HQ design.
- Electric top drive, secondary compensation system, mud pump controls, hydraulic power unit, other ancillary support functions.
- A specially designed tapered stress joint for modulating API drillstring bending stress at the HRB.

Tubing String

A small diameter tubing string is run inside ODP's 127 mm (5 inch) API drill pipe. This coring or drill rod string consists of a high strength 89 mm (3-1/2 inch) tubing with HYDRIL type 501, wedge lock threaded connections. The slimhole outer core barrel is deployed on the end of the tubing string along with the appropriate diamond bit, reaming shells, stabilizers, etc.

Diamond Core Bit

The working end of the DCS system uses a narrow kerf, diamond core bit 100.6 mm (3.96 inch) OD x 55.9 mm (2.20 inch) ID attached to an outer core barrel. Several bit options are available including diamond impregnated, surface set diamond, polycrystalline diamond compact (PDC), and geoset diamond. Bits are obtained from several vendors and their respective performance remains under evaluation.

Slimhole Core Barrel

The wireline core barrel assembly used with the DCS is a modified Longyear HQ-3 type core barrel. It has been specially developed for this application to allow deployment through the tubing string. The core barrel allows for 1.5 or 3.0 meter (5.0/10.0 feet) cores 55.9 mm (2.20 inches) in diameter to be taken. The cores are normally retrieved in plastic core liners, however split or whole steel liners are optional for high temperature applications or when fractured crystalline rock poses jamming problems.

Electric Top Drive

The tubing string is driven by a top drive powered with a 600 kW (800-hp) direct-current (DC) traction motor operating at speeds of 60 to 540 RPM. The 5,800,000 N (650 ton) API load rated unit is equipped with a gear box, open swivel, and has a maximum make/break torque of 15,000 N-m (11,000 foot-pounds). It is limited to approximately 11,600 N-m (8,300 foot-pounds) during coring operations.

The open swivel concept allows for the core barrel to be retrieved without having to disconnect from the tubing string. The existing control electronics on the ship were modified by incorporating closed-loop motor control, resulting in very accurate top-drive shaft speed, independent of torque. The ability to maintain constant speed is critical during slimhole coring operations.

Secondary Heave Compensator

For the DCS to be successful it is imperative that WOB be controlled in a precise manner. Efforts are continuing to develop an acceptable secondary heave compensation system. The job of the secondary compensator is to remove the load fluctuations resulting from the mechanical inefficiencies of the primary 3,600,000 N (400 ton) passive heave compensator. It is arranged in series beneath the larger compensator. This system is intended to provide control for WOB fluctuations of plus or minus 2,220 N (500 pounds) and compensate for drill ship motion resulting in total heave of plus or minus 300 mm (12 inches) at the DCS platform. The secondary compensator is rated for 670,000 N (150,000 pounds) of working tubing string weight.

Mud Pump Control System

Slimhole coring uses much lower circulation rates during the drilling/coring process than does roller cone rotary coring. Flow rates for slimhole diamond operations range from 40 to 190 liters per minute (10 to 50 gallons per minute or gpm) compared with 800 to 1300 liters per minute (210 to 350 gpm) or greater for conventional rotary coring operations. The drillship is equipped with two Oilwell A1700-PT triplex mud pumps driven by two 600 kW (800-hp) motors each. To adapt these existing large pumps to slimhole coring closed-loop motor controls were incorporated similar to those used in the top drive system. Using closed loop feedback the new controls allow the pumps to operate at very slow speeds. The pumps are normally equipped with 165 mm (6-1/2 inch) liners but can have 102 mm (4 inch) liners installed as required. Small liners produce 7.2 liters (1.9 gallons) per revolution. The new controls allow these pumps to operate smoothly at such low speeds as 3 rpm or 23 liters per minute (6 gpm).

Hydraulic System

The platform is equipped with a 150 kW (200-hp) hydraulic power pack. The purpose is to power the heave compensation system, wireline winch, and other secondary systems such as tuggers, etc. Main operating pressure of the system is 28,000 kPa (4000 pounds per square inch) requiring a high pressure filtering system. The pump uses a variable-displacement swash-plate design. A 1500 liter (400 gallon) oil reservoir provides ample system volume.

DCS Platform

All of the DCS operations and drilling functions are performed from a manned platform (Figure 11) suspended in the derrick. A driller's console is situated on the platform to allow over all control of the DCS including top drive, secondary compensator, and mud pump systems. This platform is approximately 13.7 meters (45 feet) tall and weighs over 18,000 kg (40,000 pounds). The work area inside the platform is approximately 2.4 x 3.7 meters (8 x 12 feet) square which allows for two to three workers to comfortably move about during coring operations. The DCS platform is stored out of the way on the rig floor and rolled into position via a portable dolly/track system when required. Power to operate the console top drive and heave compensator is supplied by two electrical umbilicals from the rig floor.

Tapered Stress Joint

The DCS drillstring requires outer stabilization in order to be deployed in deepwater. To accomplish this task, the outer string is held in tension by pulling against a seafloor structure. Typical over-pull tension is approximately 180,000 N (40,000 pounds). The DCS system uses 127 and 140 mm (5 and 5-1/2 inch) API drill pipe for this "mini" riser. The lower end of the mini-riser is terminated with a tapered stress joint, similar to an oilfield riser flex-joint. This specially designed 9.2 meter (30 feet) tapered drill collar is designed to reduce and/or eliminate any lateral motion introduced by vessel offset during drilling operations. The mini-riser concept required a thorough dynamic riser analysis before any of the equipment was designed. The analysis proved critical not only for design of the stress joint but also for the feasibility of performing deepwater DCS coring operations.

CONCLUDING REMARKS

The ODP has been a remarkably successful international scientific research program for many years and is a dramatic example of what international cooperation in the spirit of scientific endeavor can accomplish. So spectacular has the science been that it often overshadows the equally important advancements in offshore drilling technology that have come of the ODP effort.

Given the great success of the ODP it stands to reason that a well organized and adequately funded International Continental Scientific Drilling Program (ICSD) could be equally successful at achieving it's worldwide continental scientific goals and compliment the vast knowledge gathered to date through the ODP.

ACKNOWLEDGEMENTS

Science operator for the Ocean Drilling Program is Texas A & M University located in College Station, Texas. The drilling subcontractor is SEDCO-FOREX.

In addition to numerous subcontractors and industry consultants, the ODP receives technical advice and assistance from a great many companies and corporations within the oil and gas, mining, geothermal, and scientific drilling industries both domestic and abroad. Current industry representation on ODP's Technical Development Committee (TEDCOM) include: Ocean Research Institute (ORI), University of Tokyo, Japan; Shell Offshore Inc.; Institute of Petroleum Engineering (ITE), University of Clausthal, Germany; AMOCO Production Company, German Continental Drilling Project (KTB), Germany; Drilling Technology Inc.; Mobile Exploration and Production; Howard Shatto (retired from Shell Development; British Geological Survey; Institut Francais du Petrole (IFP), France; Chevron Services-Drilling Technology; Walter Svendsen (retired from Longyear); Geothermal Power Agency, Iceland; and the Commonwealth Scientific & Industrial Research Organization (CSIRO), Division of Petroleum Resources, Australia.

Scientific advice is given to the program through ten oceanographic institutions located in the USA and five international partners. Domestic institutions include the following: Hawaii Institute of Geophysics, University of Hawaii; Lamont-Doherty Geological Observatory of Columbia University; Scripps Institution of Oceanography, University of California at San Diego; Rosenstiel School of Marine and Atmospheric Science, University of Miami; College of Oceanography, Oregon State University; Graduate school of Oceanography, University of Rhode Island; Department of Oceanography, Texas A & M University; Institute for Geophysics, University of Texas at Austin; College of Ocean and Fishery Sciences, University of Washington; and Woods Hole Oceanographic Institution. Foreign partners include the Department of Energy, Mines, and Resources, Earth Sciences Sector, Canada/Bureau of Mineral Resources, Geology and Geophysics, Australia; the European Science Foundation Consortium for the Ocean Drilling Program; Bundesanstalt fur Geowissenschaften und Rohstoffe, Germany; Institut Francais de Recherche pour l'Exploitation de la Mer (IFREMER), France; University of Tokyo, Ocean Research Institute, Japan; and the Natural Environment Research Council, United Kingdom.

The program is funded by the U.S. National Science Foundation (NSF) through the Joint Oceanographic Institutions, Inc. NSF receives contributions from the non-U.S. members. The contributions of personnel at TAMU, E-DGO, JOI, JOIDES, NSF, SEDCO, private industry, and the international community are greatly appreciated.

REFERENCES

- [1] M. A. Storms, Ocean Drilling Program (ODP) Deep Sea Coring Techniques. Marine Geophysical Researches 12: 109-130, 1990.
- [2] J. E. Miller & D. P. Huey, Development of a Mud-Motor Powered Coring Tool. OTC 6865. Offshore Technology Conference, May 1992.
- [3] W. C. Rhinehart, A Prototype Hard Rock Core Orientation System for Partial Core Recovery. Fourth Canadian Conference on Marine Geotechnical Engineering, June 1993.
- [4] M. A. Storms, S. P. Howard, D. H. Reudelhuber, G. L. Holloway, P. D. Rabinowitz & B. W. Harding. A Slimhole Coring System for the Deep Oceans. SPE/IADC 21907. Society of Petroleum Engineers/International Association of Drilling Contractors Drilling Conference, March 1991.
- [5] M. A. Storms, Scientific Drilling and Coring of Mid-Ocean Ridges - Roller Cone Versus Slimhole Diamond Coring Techniques. JOIDES Journal, June 1991.
- [6] M. A. Storms, T. J. G. Francis, Ph.D., B. W. Harding, D. P. Huey, G. L. Holloway, D. H. Reudelhuber, P. D. Rabinowitz, Ph.D., Advanced Drilling Technology for Scientific Ocean Drilling. Offshore Australia Conference, November 1993.
- [7] D. S. Hammett and A. R. McLerran, Ocean Drilling Program: Vessel/Equipment Capabilities (OTC 4990). Offshore Technology Conference, May 1985.

OCEAN DRILLING PROGRAM
ROTARY CORE BARREL (RCB)
WIRELINE CORING SYSTEM

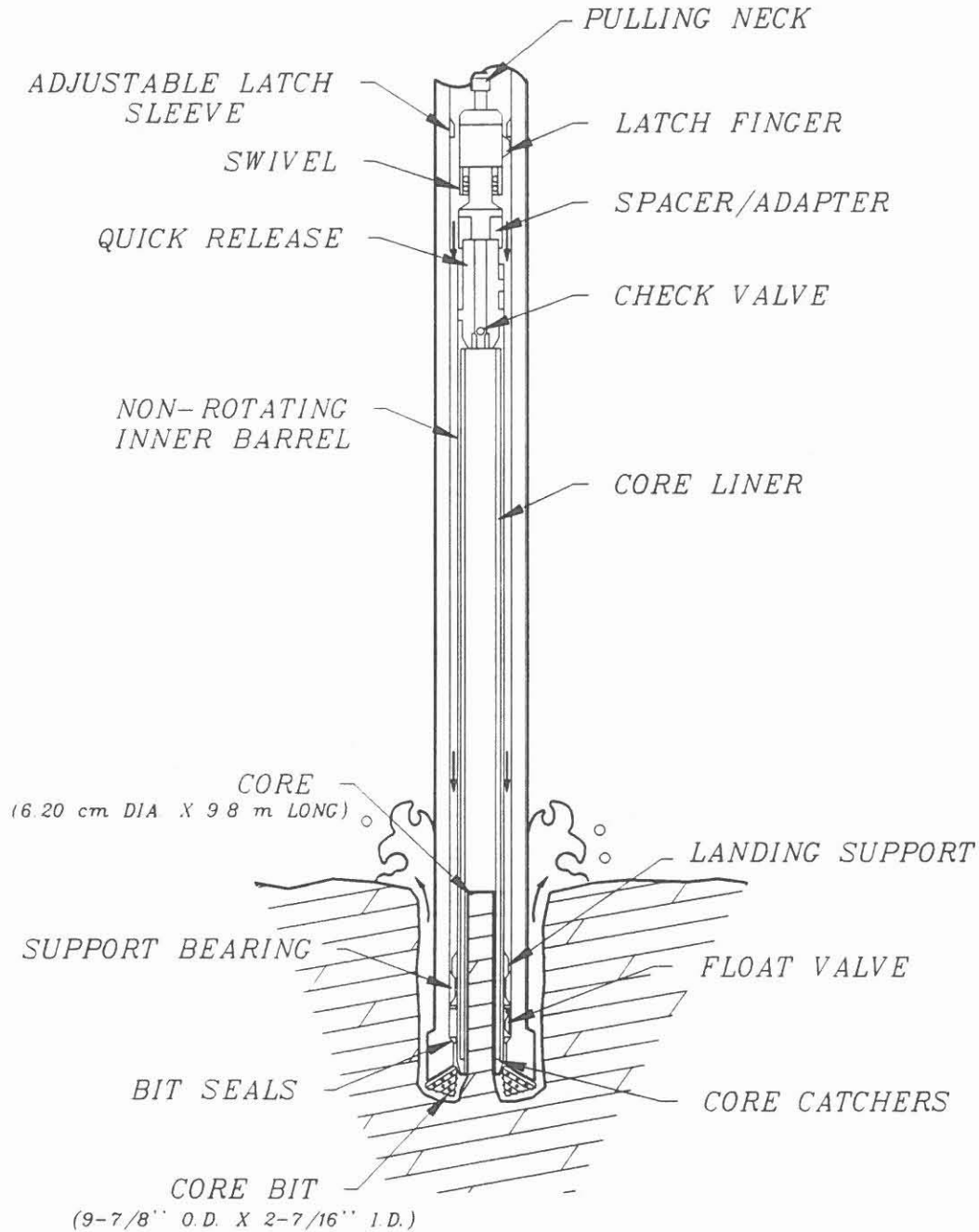

FIGURE 1

ADVANCED PISTON CORER (APC)
OCEAN DRILLING PROGRAM

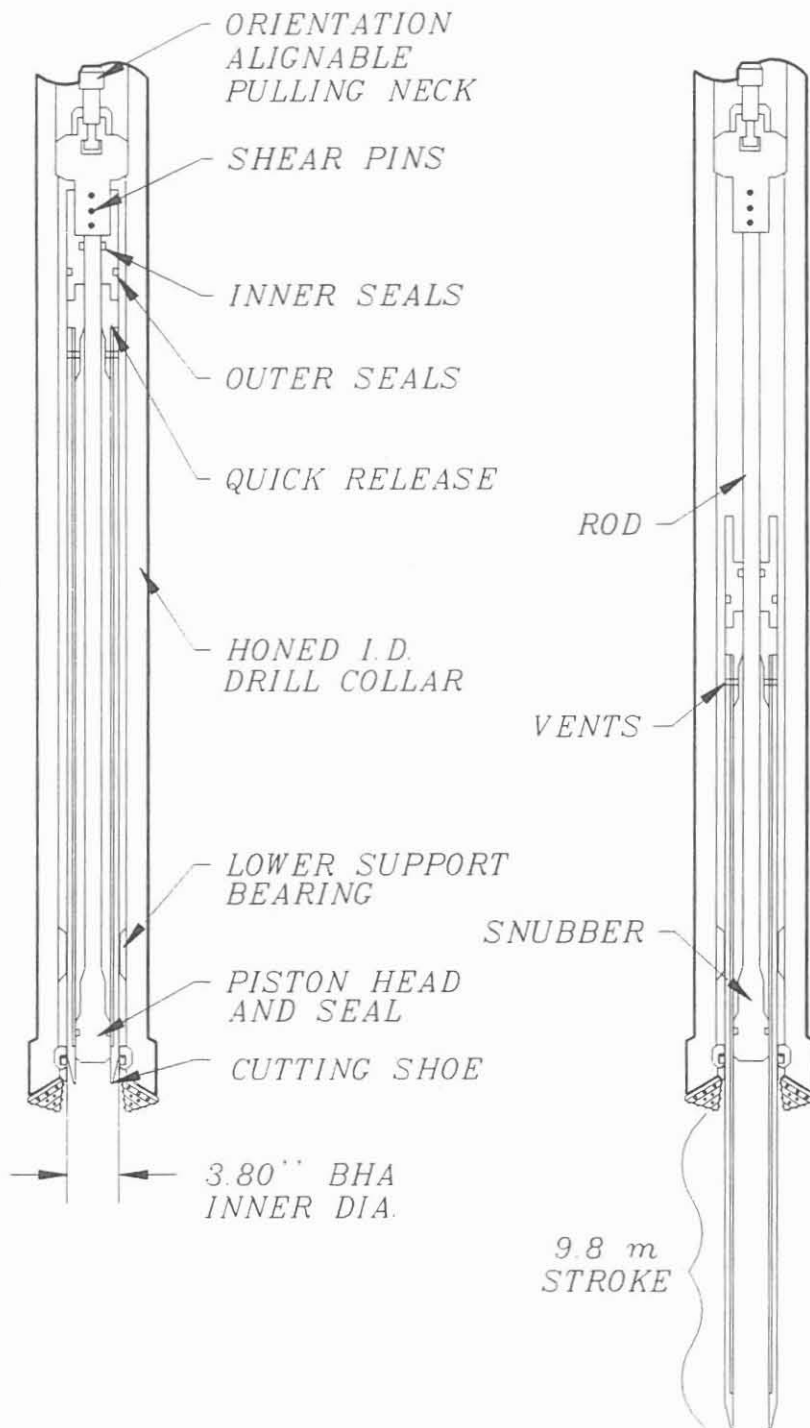

FIGURE 2

EXTENDED CORE BARREL (XCB)

CORING
SOFT
SEDIMENT

CORING
HARD
SEDIMENT

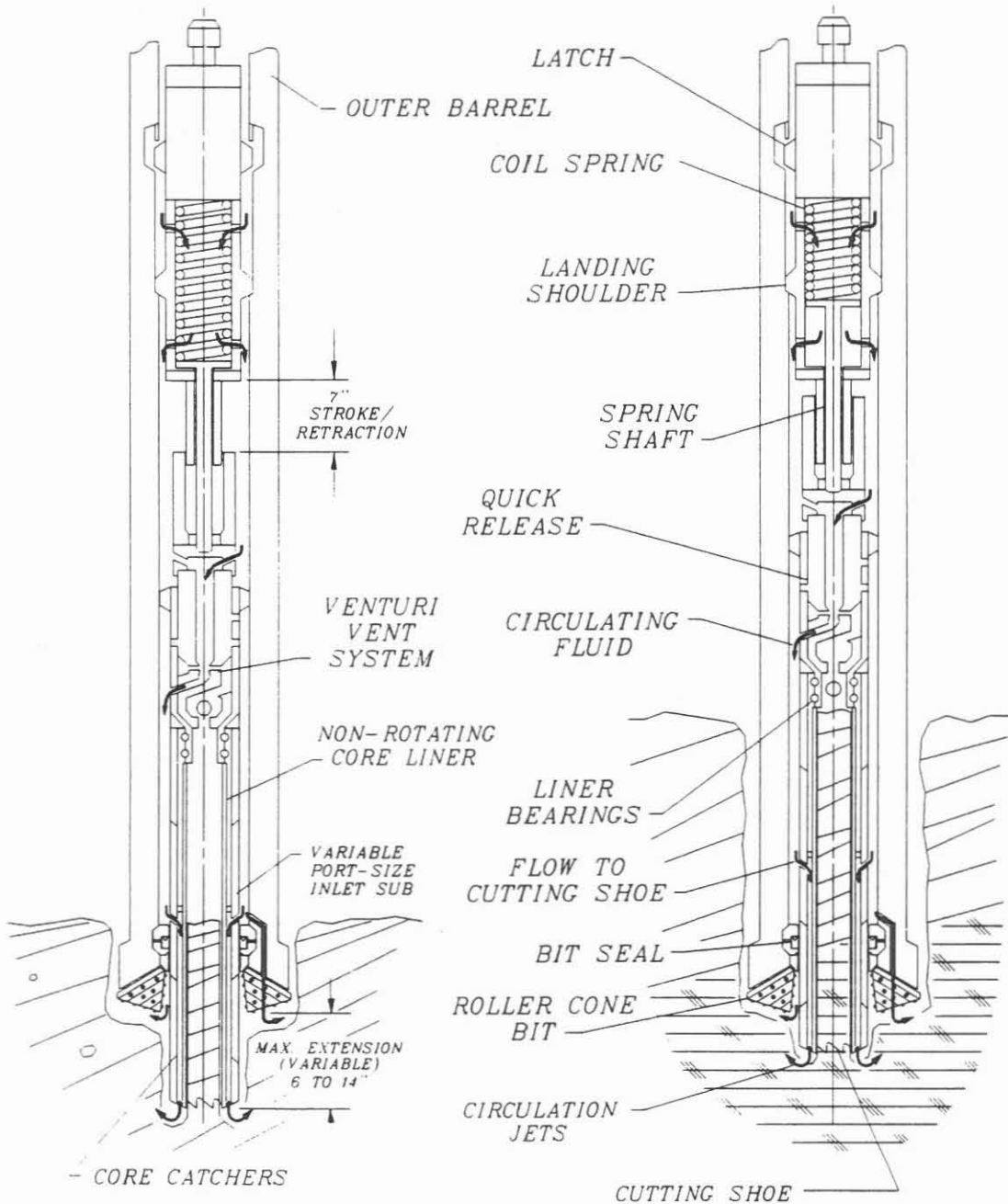

FIGURE 3

MOTOR DRIVEN CORE BARREL
(MDCB)
OCEAN DRILLING PROGRAM

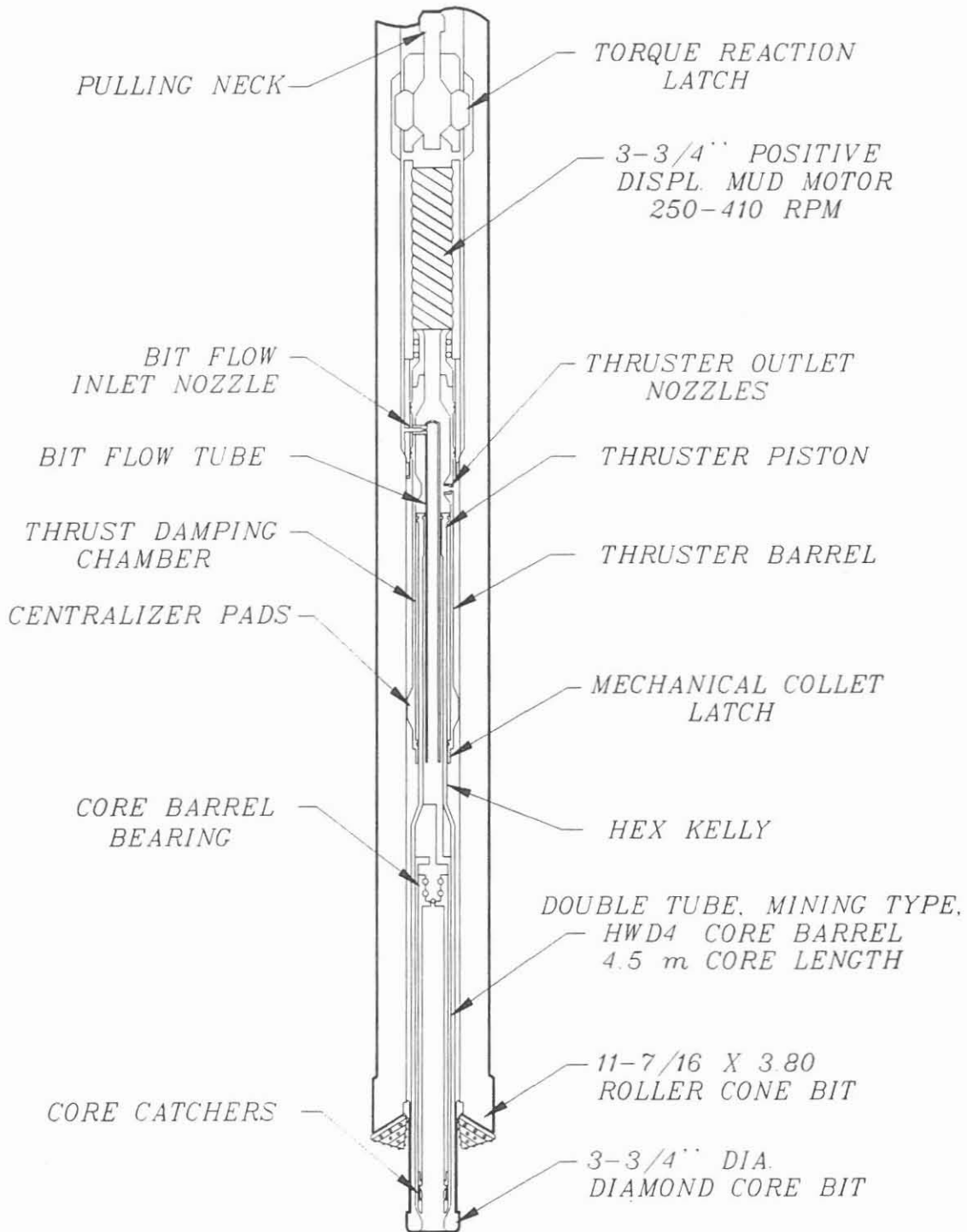
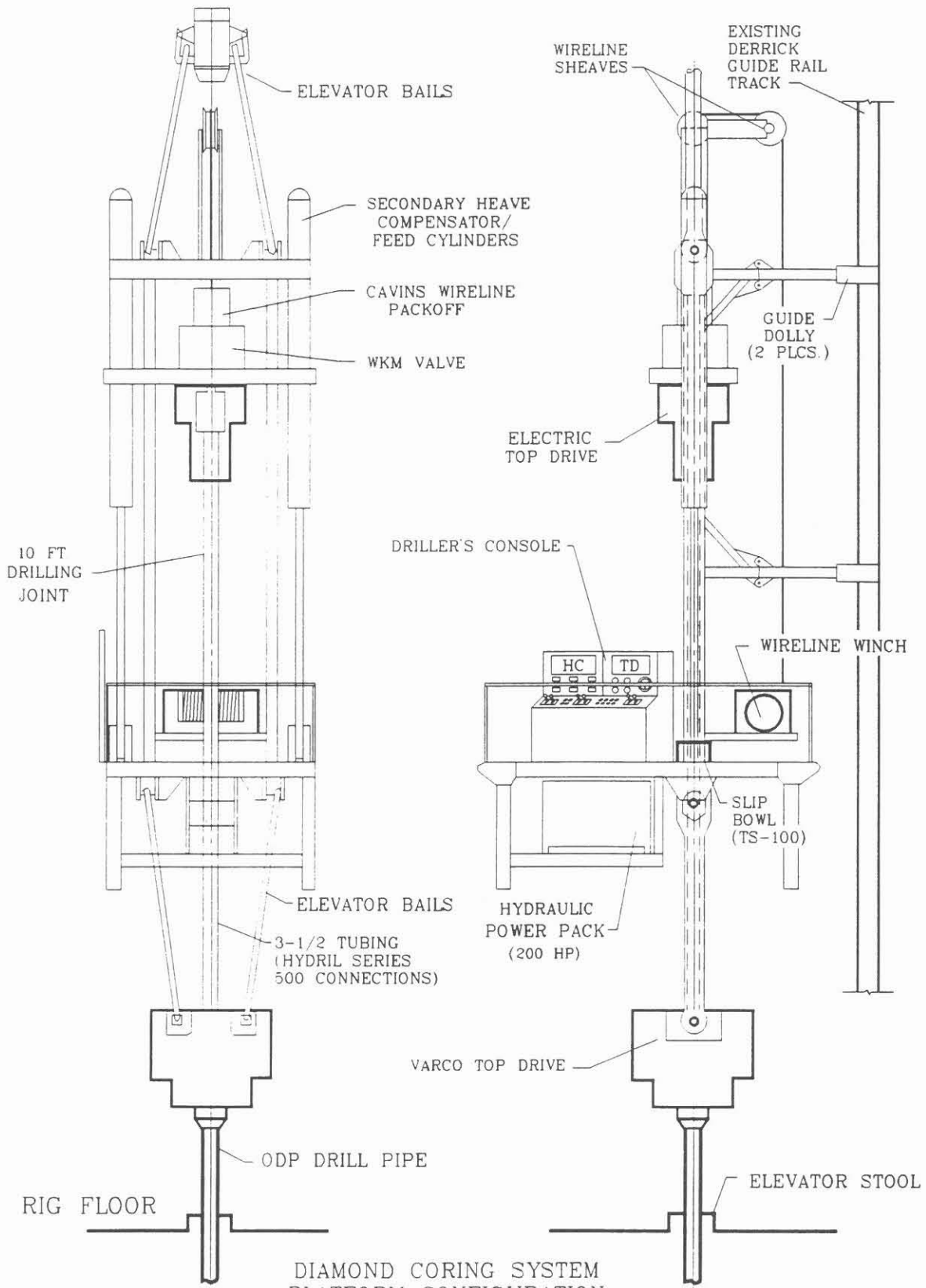

FIGURE 4



DIAMOND CORING SYSTEM
PLATFORM CONFIGURATION
PHASE II - 4500 METER DEPTH CAPACITY

FIGURE 5

OCEAN DRILLING PROGRAM
SONIC CORE MONITOR

PHASE I
FEASIBILITY PROTOTYPE W/XCB SYSTEM

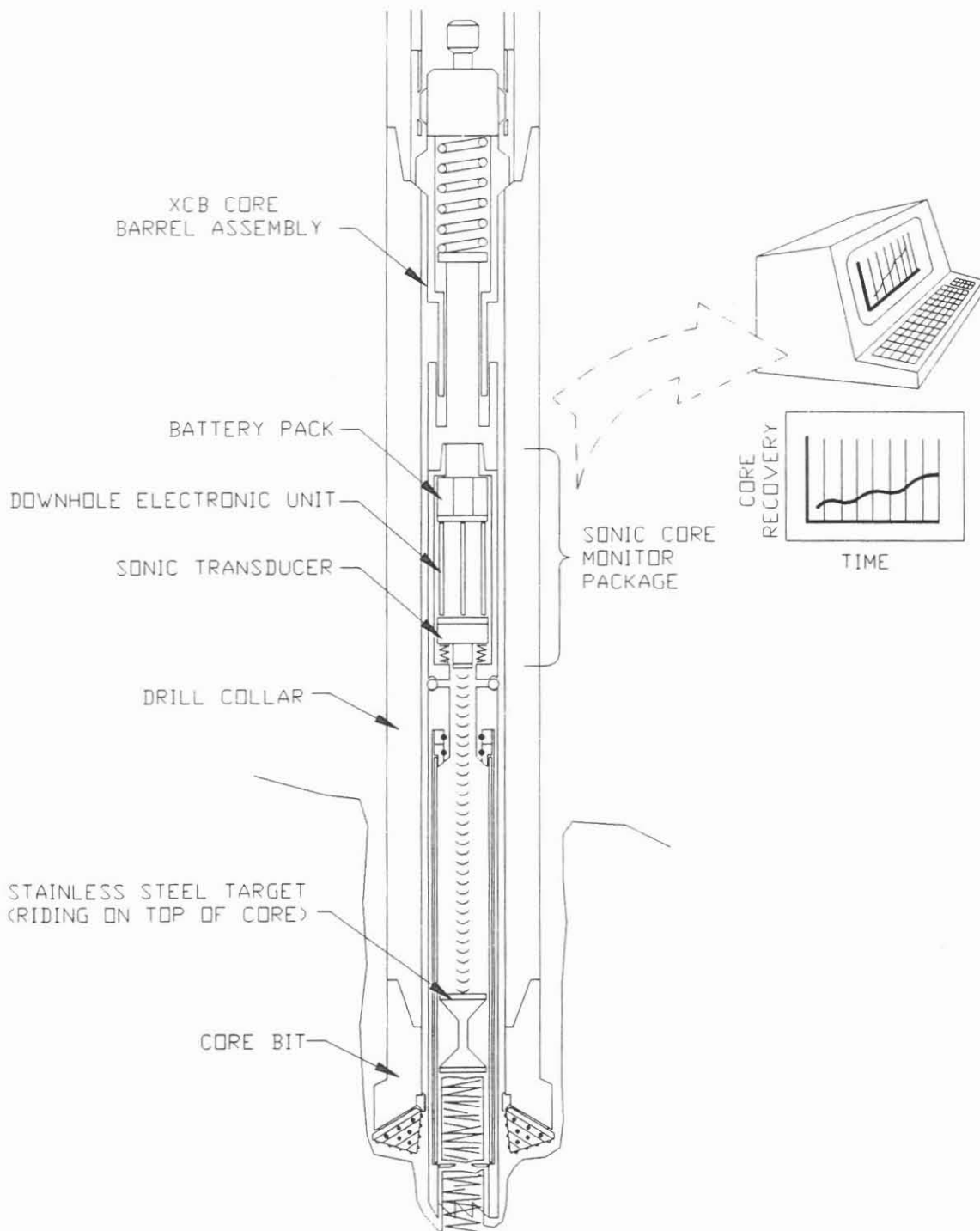

FIGURE 6

SCM CORE RUN DATA

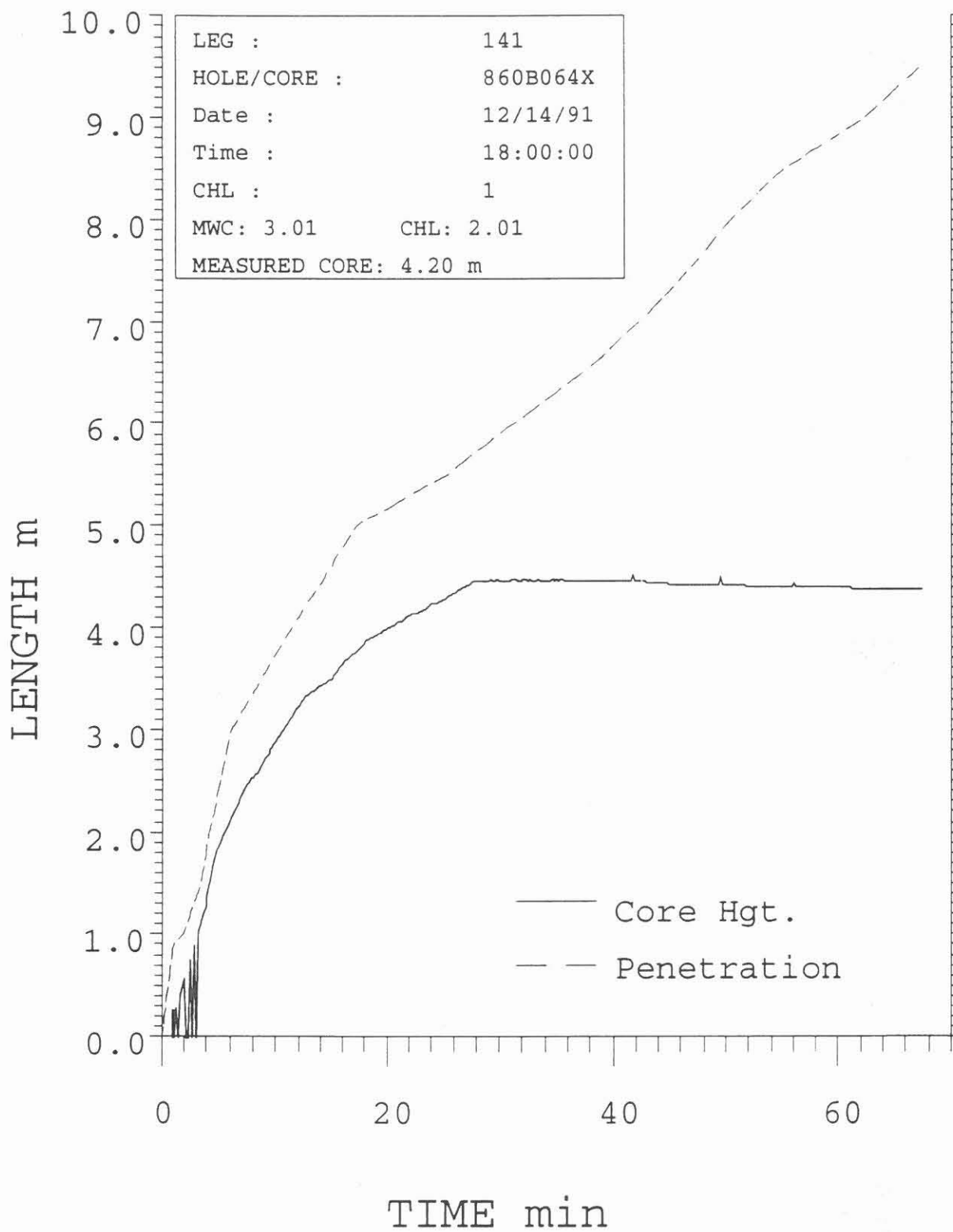
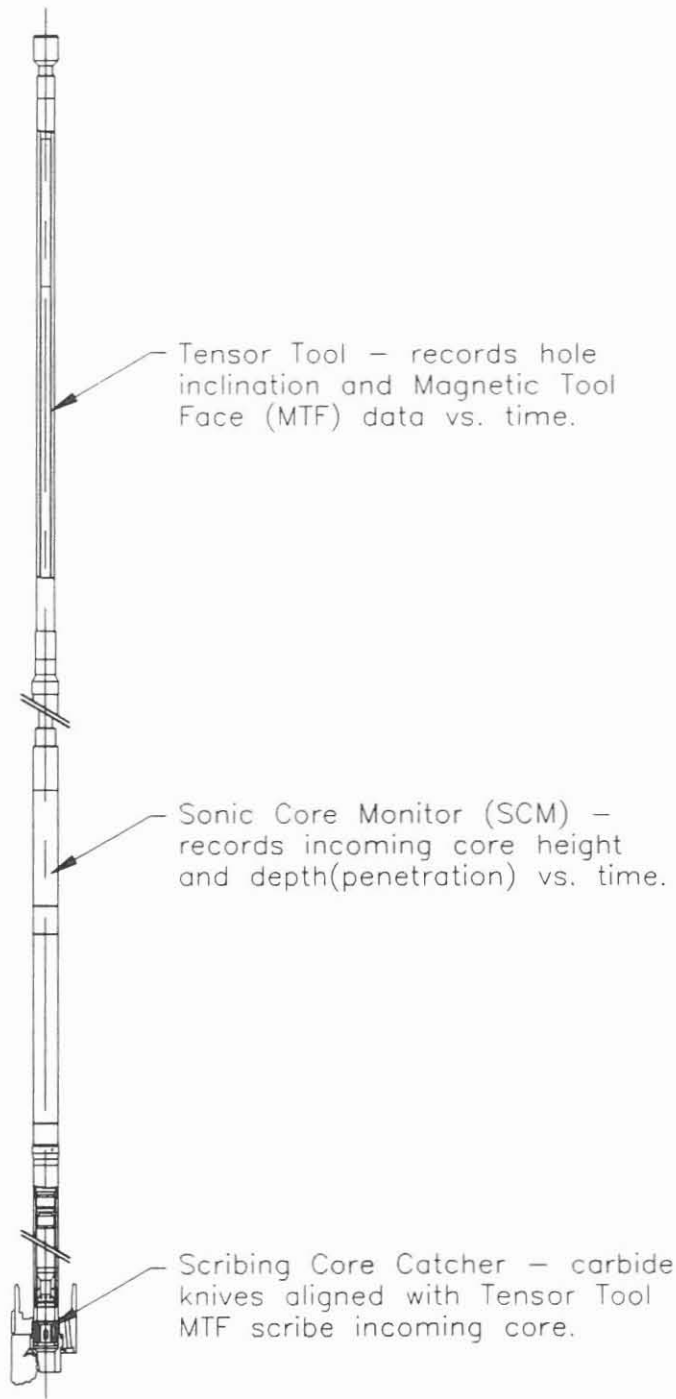

FIGURE 7

Hard Rock Orientation (HRO)

RCB System only

HRO
WCR
3/12/92



"CHAMP" Software

Time	Inc	MTF
2:00	3°	265°
2:15	3°	267°
2:30	3°	268°

"MWC" Software

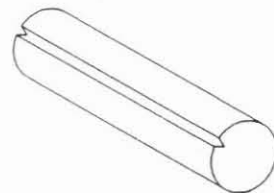
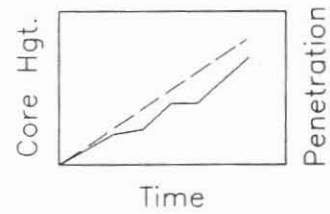

FIGURE 8

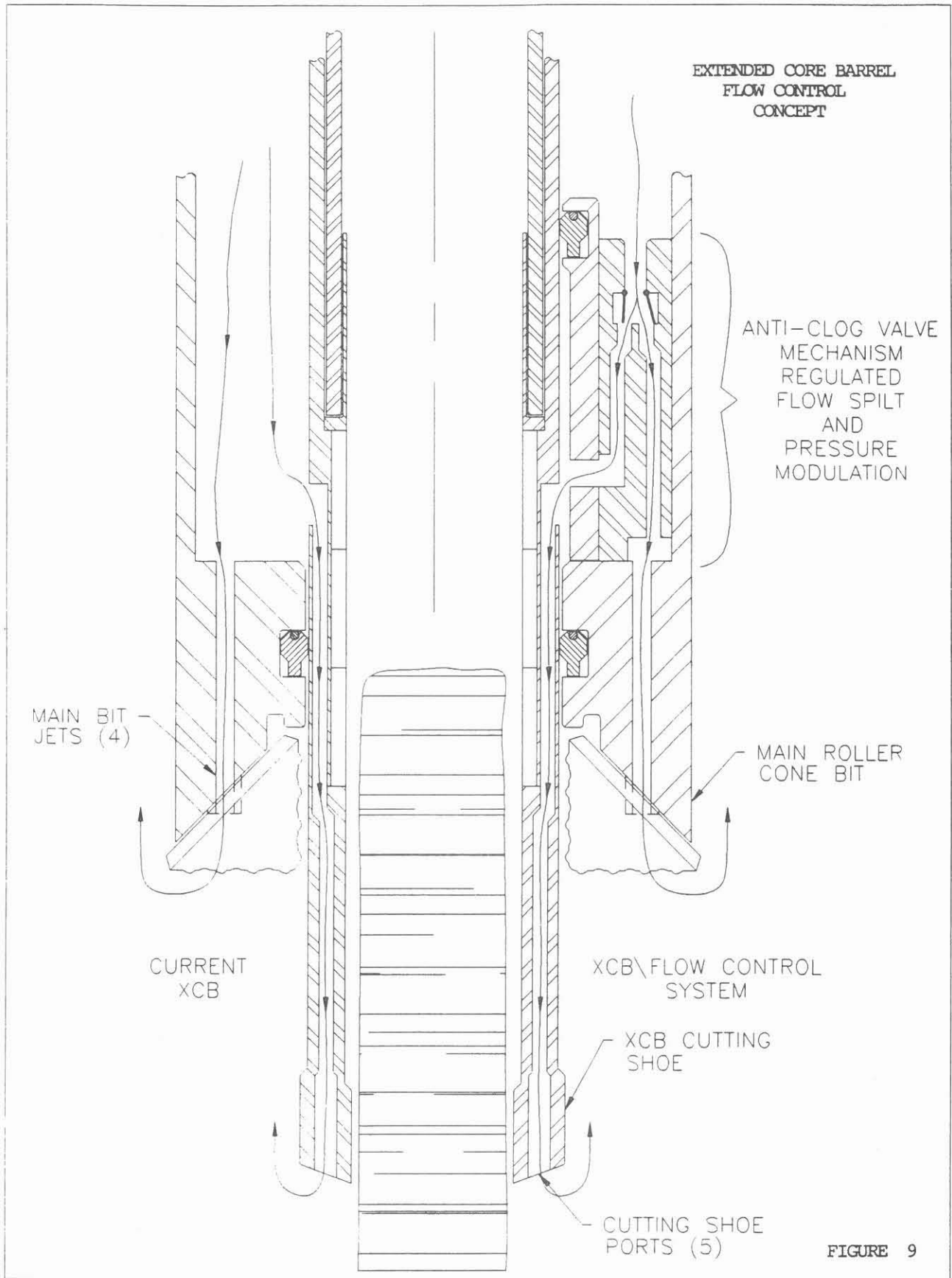

FIGURE 9

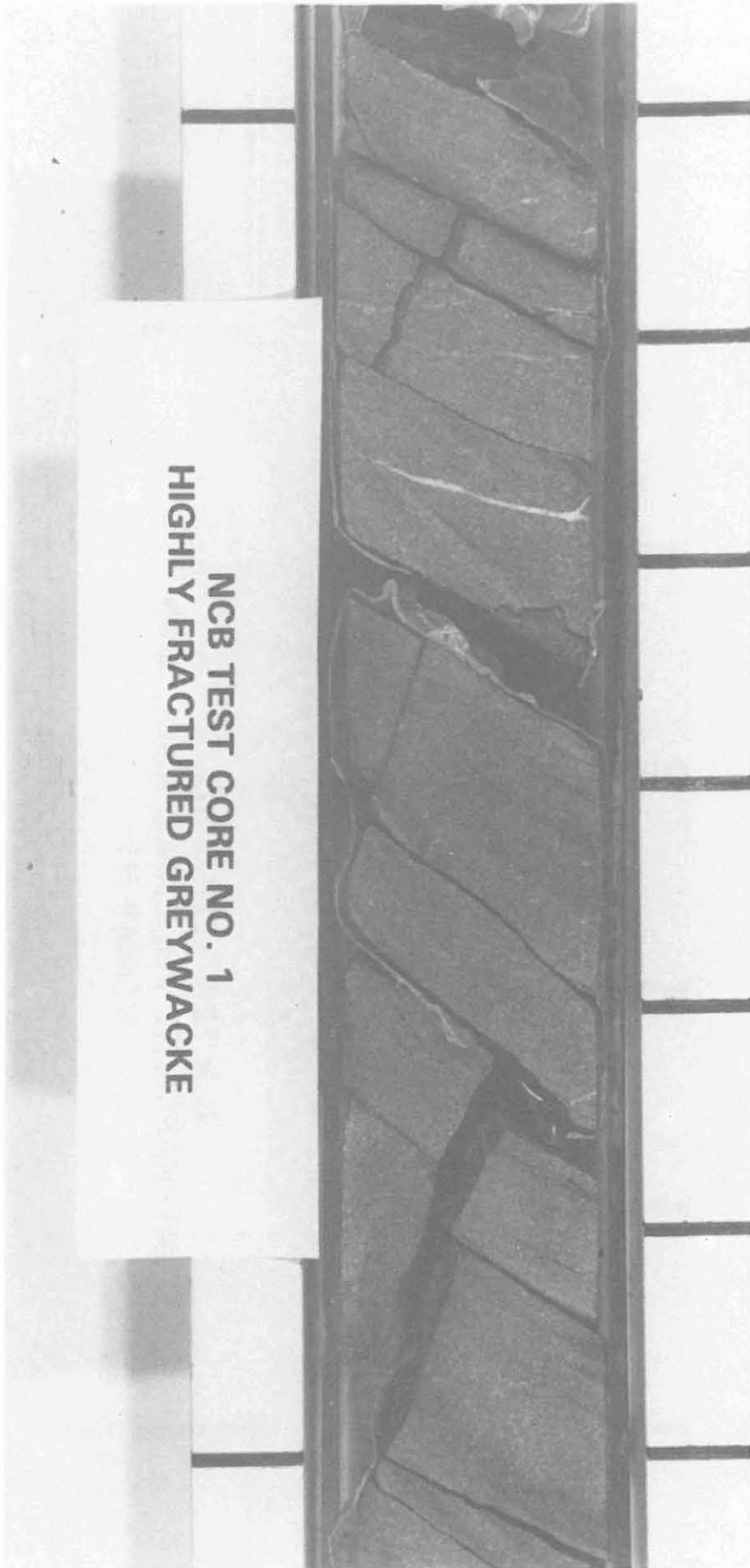

FIGURE 10



FIGURE 11



FIGURE 12

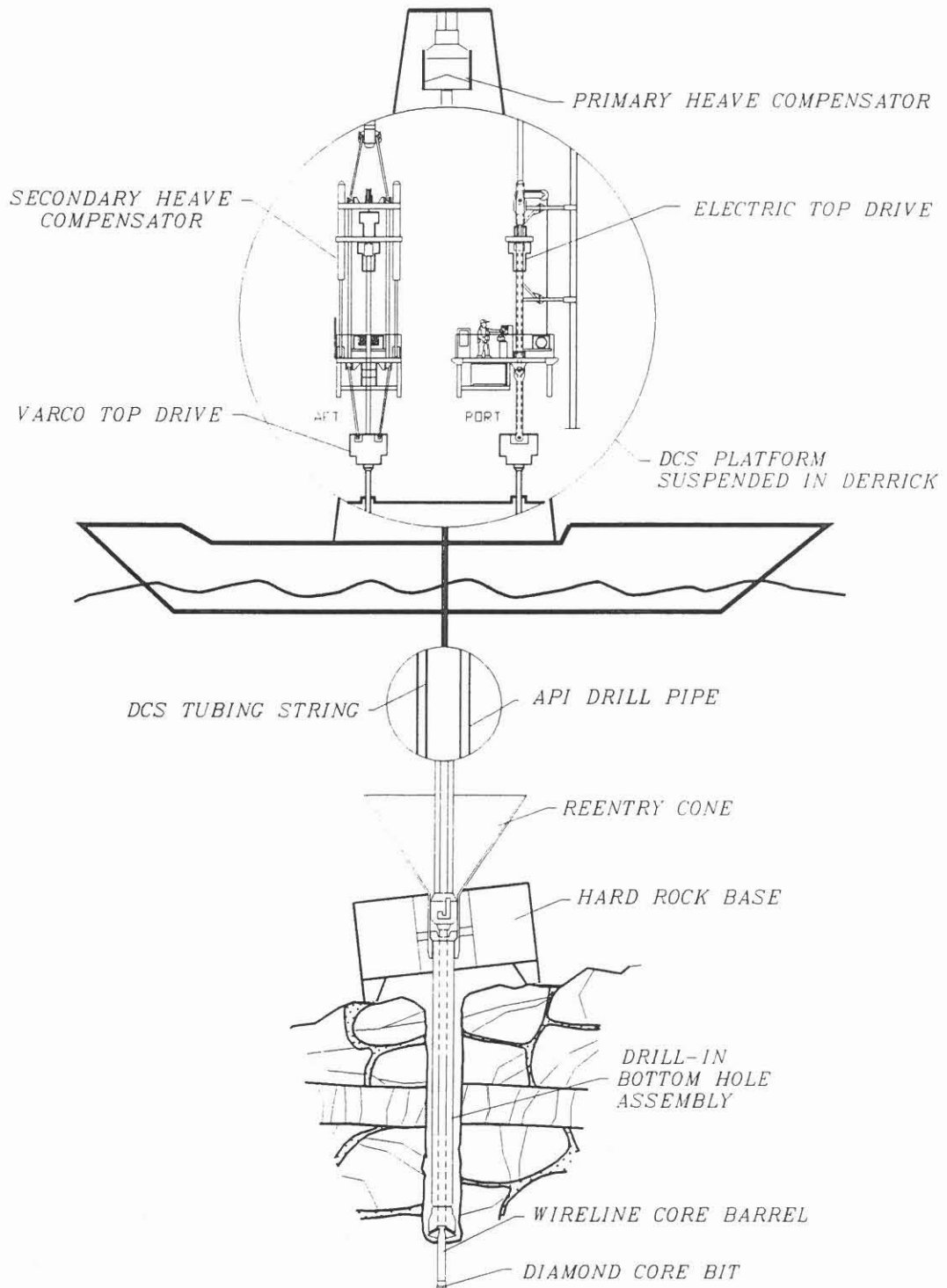

DIAMOND CORING SYSTEM

FIGURE 13

Technological problems while drilling superdeep wells

B. N. Khakhaev

NEDRA Company
Volkushi, 28
150003 Yaroslavl / CIS

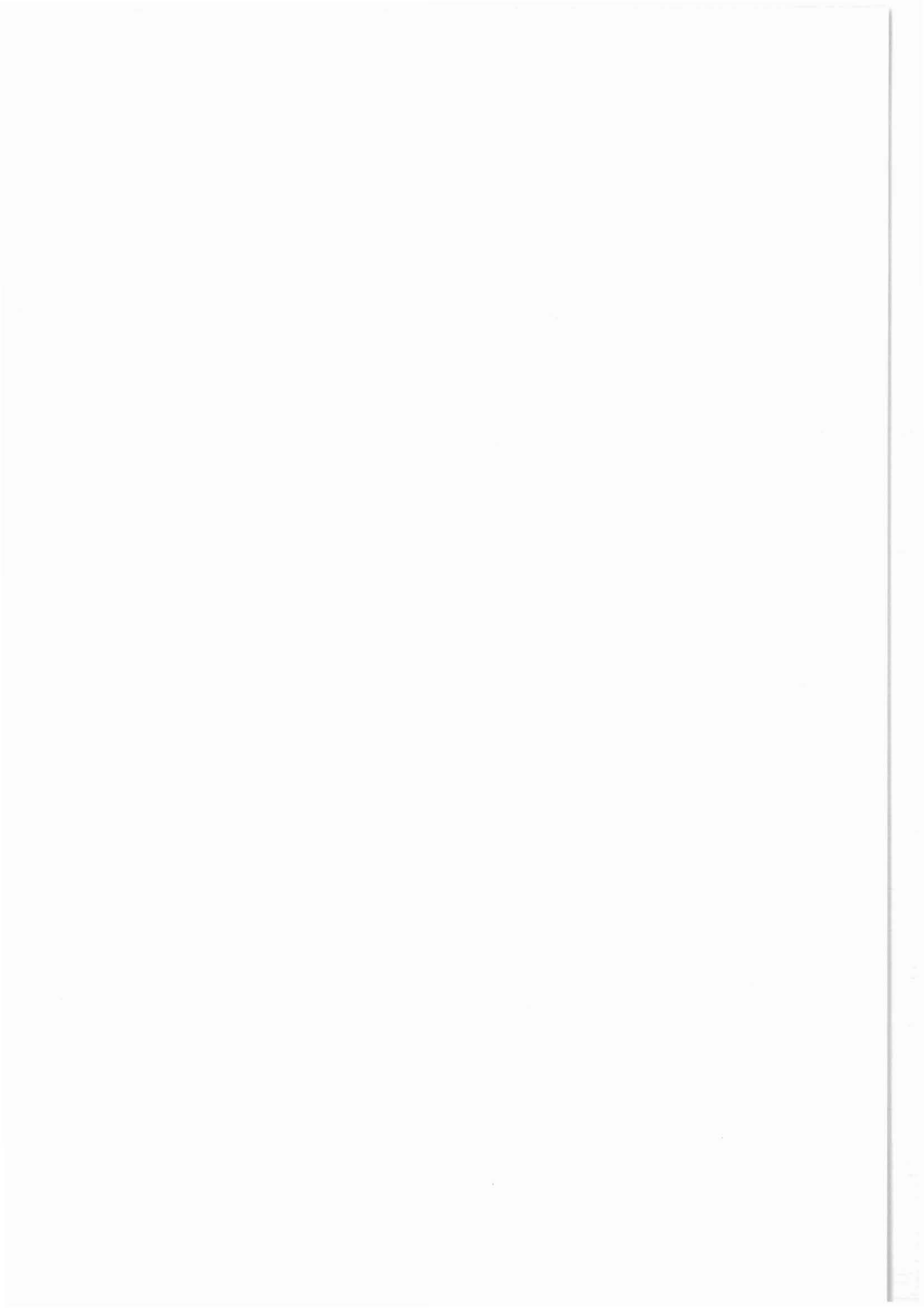

TECHNOLOGICAL PROBLEMS WHILE DRILLING SUPERDEEP WELLS

Khakhaev, NEDRA, Yaroslavl - CIS -

Dear colleagues: Probably it won't be a mistake if I say that the main tool to understand a deep structure of the Earth's crust and processes that occur in it is a direct penetration into the depth by way of a drill hole. Therefore one can understand a desire of scientists to reach a technologically feasible depth of the Earth's crust. That is why site selection for drilling superdeep wells is preceded by a thorough analysis of geological-geophysical materials on proposed geological regions.

Scientists of different fields, often having different opinions and developing different geological models participate in this discussion.

But even after analysis of geological-geophysical materials and additional work, geological data turn out insufficient for selecting an optimum borehole design:

We have:

1. Deficiency of geological-geophysical data on the section and conditions of drilling a well
2. Supposed conditions of drilling a well:
 - a) stressed state of the rock,
 - b) pressure of fluids and gases,
 - c) temperature,
 - d) complications with a borehole and others.

In a consequence of lack of information it is necessary to improve a borehole design, technology and tools while drilling.

The cost of drilling a well will mainly depend on the accuracy of prognosis of possible complications.

Therefore to know regularities of rock behaviour while drilling is an important task. "Nedra" is drilling a number of wells in a crystalline rock that has resulted in finding out the following:

Real geological data, obtained while drilling and investigating wells.

1. Complex stressed state of the rock is a total value of:
 - a) lithostatic pressure which changes with depth regarding the value and direction of tectonic stress and
 - b) intralayer pressure.
2. Heterogeneity of strength properties and stability of the section as a result of
 - a) petrophysical heterogeneity,
 - b) interchange of consolidated and unconsolidated rocks,
 - c) differently orientated disconformable boundaries,
 - d) different level of fluid saturation of the rock and
 - e) presence of ruptured tectonics.
3. Increase of T with depth.
4. Presence of anomalous formation pressure against an increase of formation pressure with depth.

Interaction of these geological factors with a borehole, as workings, that has changed a static state of the rock resulted in following:

Results of influence of geological factors on the well.

1. Formation of an elliptical nearly wedged-type borehole with a cross-section that exceeds a bit size.
2. Break-outs, caving.
3. Core destruction and its discing.
4. Spontaneous change of the trajectory and deviation of the borehole.

Maybe this or that method can decrease the intensity of these processes but a regularity remains therefore the drilling technologies should be adapted to this.

Let us dwell upon these peculiarities in more details.

The following slides show changes in the Kola borehole cross-section. At a lower depth this phenomenon was observed in all the wells drilled in a crystalline rock. (Fig. 1,2)

Break-outs and caving were especially severe in the Krivoy Rog and Ural wells at a depth of 3,5 - 4,5 km. The break-outs mainly correspond to reflectors that permits to

make prognosis and to take up preventive measures. Causes of break-outs that were going on for 2 - 3 months have been revealed and a technology to prevent them has been developed.

Regarding a borehole inclination it should be said that all the wells in a crystalline rock had it of 14 - 35°. It was a serious factor that hampered drilling.

The Kola well was mostly characteristic in this respect, where 4 side tracks were drilled while developing a technology of vertical drilling. As it is seen in the figure inclination occurred in the same interval. These specific peculiarities of wells in a crystalline rock have led to a number of technological consequences. (Fig. 3)

Technological consequences of peculiarities of the state of a well.

1. Growth of drag to movement and rotation of a drill string.
2. Difficulties with recovery of fallen rock in a cavernous borehole under a limited rate of circulation of the flushing fluid.
3. Necessity to use non-standard methods for controlling a borehole trajectory.
4. To strengthen requirements to PT -resistivity of tools for drilling, testing and investigating wells.

To estimate drag in the Kola well we made:

- borehole measurements before lowering a 245 mm casing,
- similar measurements after correcting a borehole trajectory and lowering a casing down to a depth of 8.77 km,
- calculations of a maximum permissible inclination angle at a depth of 14.5 km and corresponding drag. (Fig. 4,5)

Further investigations showed that drag depends on friction, configuration of the borehole and changes of spatial parameters (angle and azimuth of inclination).

Of course it is difficult to precisely take into consideration the influence of these factors. Estimated data verified in practice showed distribution of drag in the Kola well.

These data were verified in four side tracks that had been drilled below 9 km in the Kola well. Horizontal projections of these side tracks are shown in Fig. 2.

Vertical projections are shown in Fig. 1,6.

Decrease of drag can be achieved by borehole vertically and its configuration. But existing bottom hole assemblies meant for a nominal borehole diameter are not effective in a cavernous borehole. Borehole assemblies designed to build up certain efforts on the lying side of the borehole sharply decrease the efficiency of drilling operations.

Turbine-rotary drilling proved to be efficient to provide verticality of the upper part of the borehole of a large diameter. This technology was used to drill the Ural well down to 4 km and Krivoy Rog well down to 3.2 km. In this case inclination did not exceed 3 deg (Fig. 7).

Experience of drilling of wells in a crystalline rock showed that efficiency of cutting the rock by a bit depends not only on rock composition but also on its stressed state. The higher is the rock stress the easier it is destroyed. This phenomenon has its negative aspect - formation of cavernous borehole and break-outs. It results in poor recovery of rock from the bottom hole and its concentration in caves (Fig. 8)

This experience acquired through practice indicates that geological environment imposes some limitations on the drilling methods.

To our mind rotary drilling with steel pipes is applicable only down to a depth of 10 km because of the growth of drag to rotation and pulling-out of the drill string.

Existing turbine drilling with light alloy pipes has a certain advantage but even it can be used down to a depth of 14-15 km. The limitation is connected with necessity of rotating the drill string at 2-3 r/min to prevent its suspension.

Below there are shown the main elements of a well-known rotary drilling technology and their technological realization. Other methods are still under testing.

ELEMENTS OF TECHNOLOGY

EXISTING REALIZATION

Cutting of rock
Drive of a rock cutting tool
Replacement of rock cutting
tools and downhole motors

Machine rotary drilling
Downhole motors or rotary
Running in and pulling out
of the drill string

Casing of borehole walls of casings	Lowering and cementation
Removal of cut rock	Flushing
Sampling of rock	Coring
Control of borehole trajectory	Application of rigid or pendulum non-orientated bottom hole assemblies
	Application of orientated assemblies with deviating elements
Creation of return pressure onto formations reservoirs	Control of density of a flushing fluid

This existing technology does not provide efficiency of operations and has its limitations of application. These limitations are shown in the following slide:

LIMITATIONS OF APPLICATION	METHODS TO OVERCOME LIMITATIONS
T°	Development of high torque downhole motors with thermal resistivity up to 400-500° C
	Development of geophysical tools which are lowered on pipes and cooled by a flushing fluid
Insufficient strength of a drill string	Increase of strength of a pipe material, lessening of the weight and creation of controlled buoyancy
Difficulties with lowering of heavy casings	Creation of controlled buoyancy
Wear of casings	Prevention of borehole inclination Protection of casings against wear Reduction of the number of round trips at the expense of increase of penetration per bit and application of more improved coring systems
Increase of drilling duration and wear of casing due to decrease of penetration per run	Reduction of amount of coring at the expense of: analysis of cuttings, sidewall coring and coring without pullig-out of a drill string

Impossibility of orientation from the surface under a large depth and low rigidity of a drill string

Active self-orientated bottom hole assemblies of a drill string

High torque of a drill string

Rotation of the lower part of a drill string

Necessity of scientific observation of a deep structure of the Earth will probably require drilling deeper wells. How these problems are to be solved? One thing is certain it will be drilling by way of downhole motors. Existing downhole motors can be operated under a limited T range - 250 deg. C. Maybe the limit will be raised to 350 deg. C.

GNPP Nedra develops downhole motors without rubber parts which can operate under T up to 500 deg. C. Torque and number of revolutions can be adjusted in the motors.

The second and the most important problem is a drill string weight. It would be mostly efficient if the drill string weight could be controlled in a flushing fluid. The first experiments with application of special coatings on a drill string which lighten its weight indicated that application of such a string allows to solve the problems mentioned above and to improve efficiency of drilling thanks to:

1. Reduction of round trip costs.
2. Protection of casings from wear.
3. Use of large diameter pipes for drilling wells with downhole motors which are lowered through drill pipes and collapsible bits.

Creation of controlled buoyancy due to special coatings for pipes (light- alloy aluminium, titanium and others) and control of mud density could increase a drilling depth (Fig. 9).

Application of the same method for casings will permit to lower one-piece casings to any depth.

In this case there are no longer problems connected with the influence of a borehole inclination on a drilling depth and the existing drag to pulling- out of a drill string.

While drilling with bits of more than 270 mm in diameter there is a possibility to develop downhole rotators which are put into a drill string.

Researchers of GNPP Nedra develop technologies that can be applied for a cavernous borehole and provide its verticality.

At big depth borehole measurements by way of wireline tools and liquidation of failures related to a cable have become a problem. In this case it would be useful to have self-operating devices which are lowered on drill pipes and cooled by a flushing fluid.

Tentative testing of tools for drilling of superdeep wells and borehole investigations, which are being developed by specialists of different countries could be conducted in the Ural well with a projected depth of 15 km and the Tunkin well with a projected depth of 7 - 8 km which is located in the Baikal rift zone.

Along side with geological data there is a possibility to obtain information on drilling technologies and to conduct joint testing of new technical means.

I would like to draw a conclusion from all that have been said above:

Determined regularities of crystalline rock behavior in the process of drilling allow to specify the trend of research work on development of new technologies that would provide efficient drilling of wells down to a depth of more than 15 km.

THE KOLA SUPERDEEP WELL
Profile, azimuth=250°

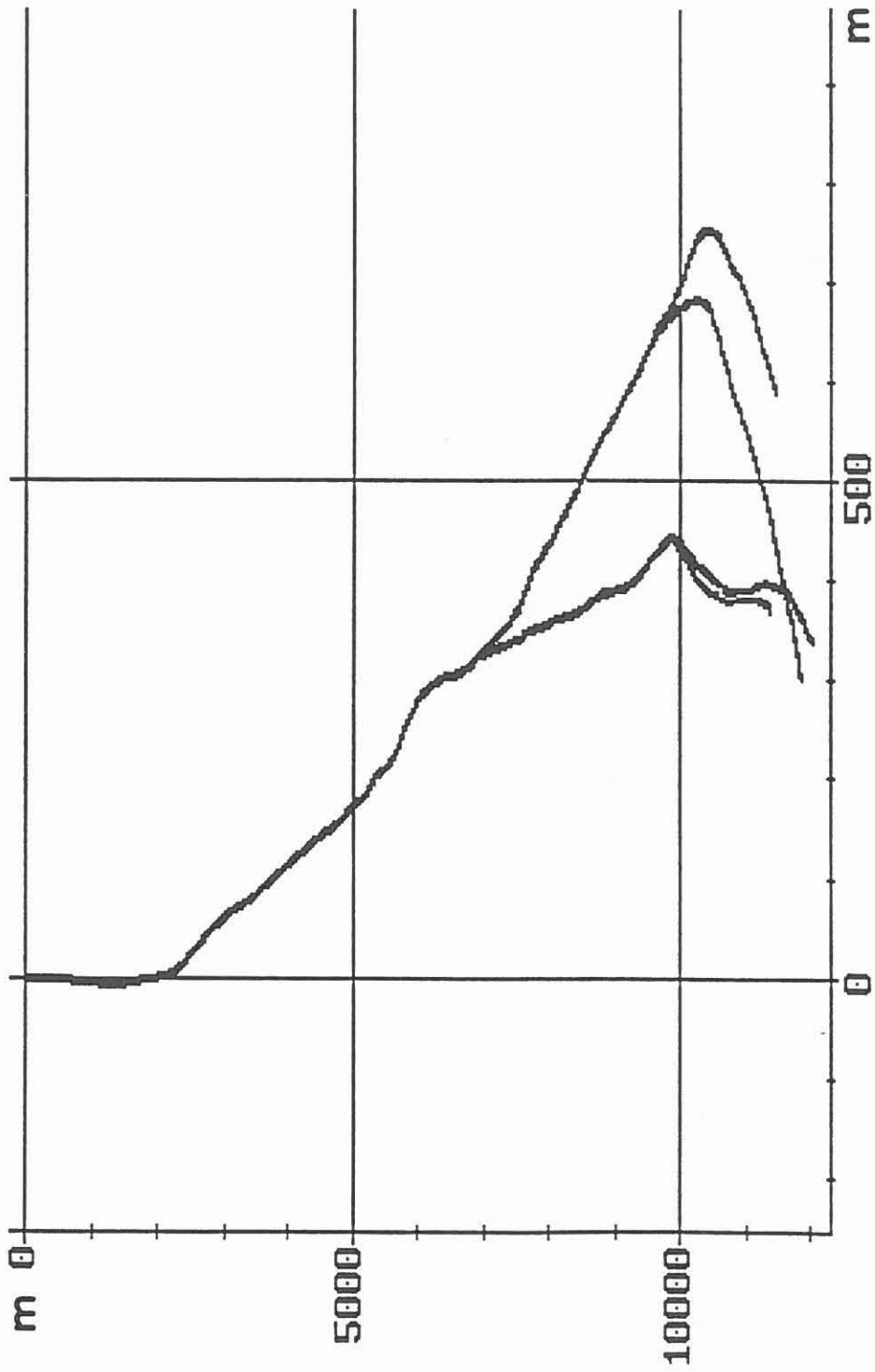

FIG. 1

THE KOLA SUPERDEEP WELL
Projection, azimuth=0°

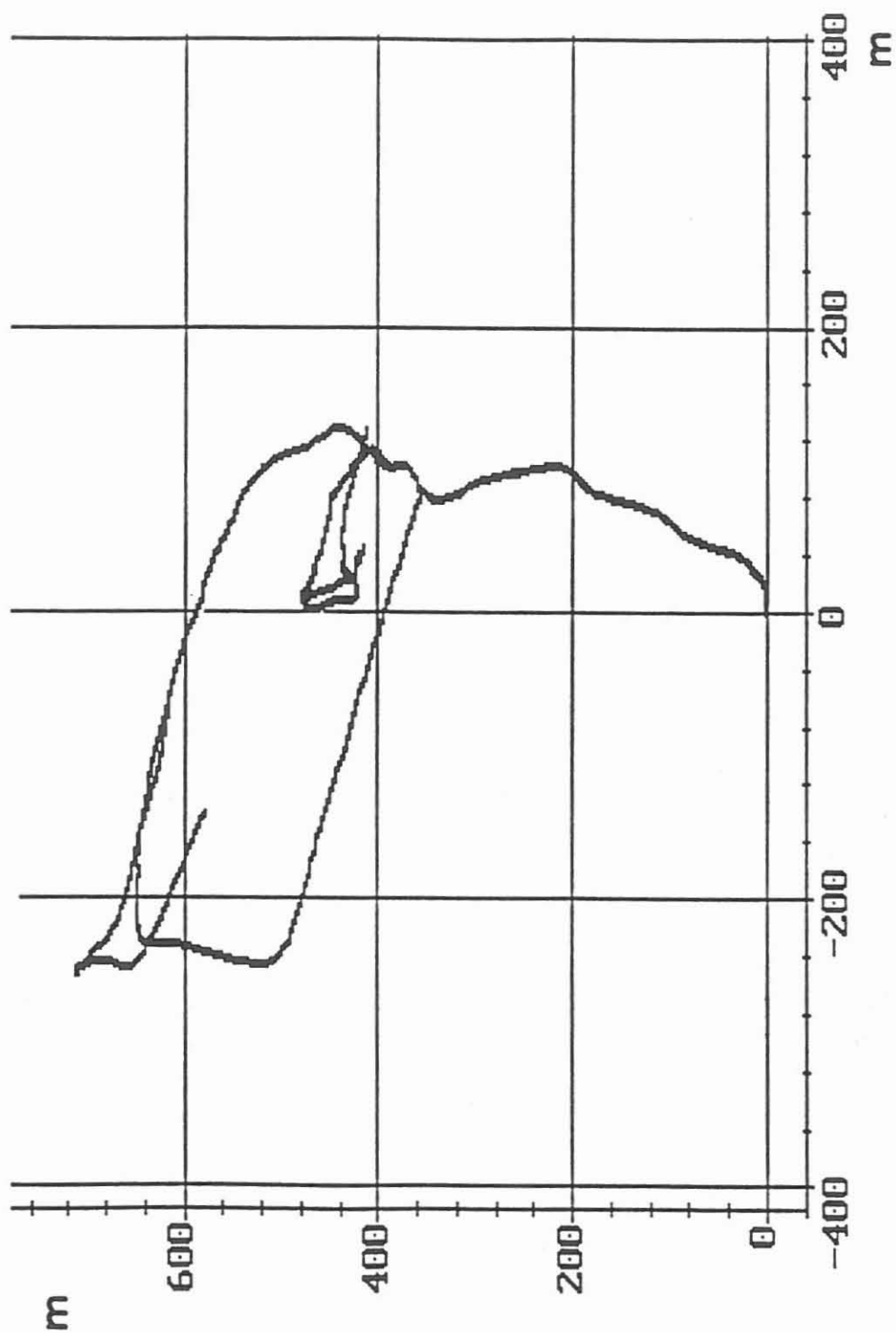

FIG. 2

INSTABILITY OF THE BOREHOLE WALLS

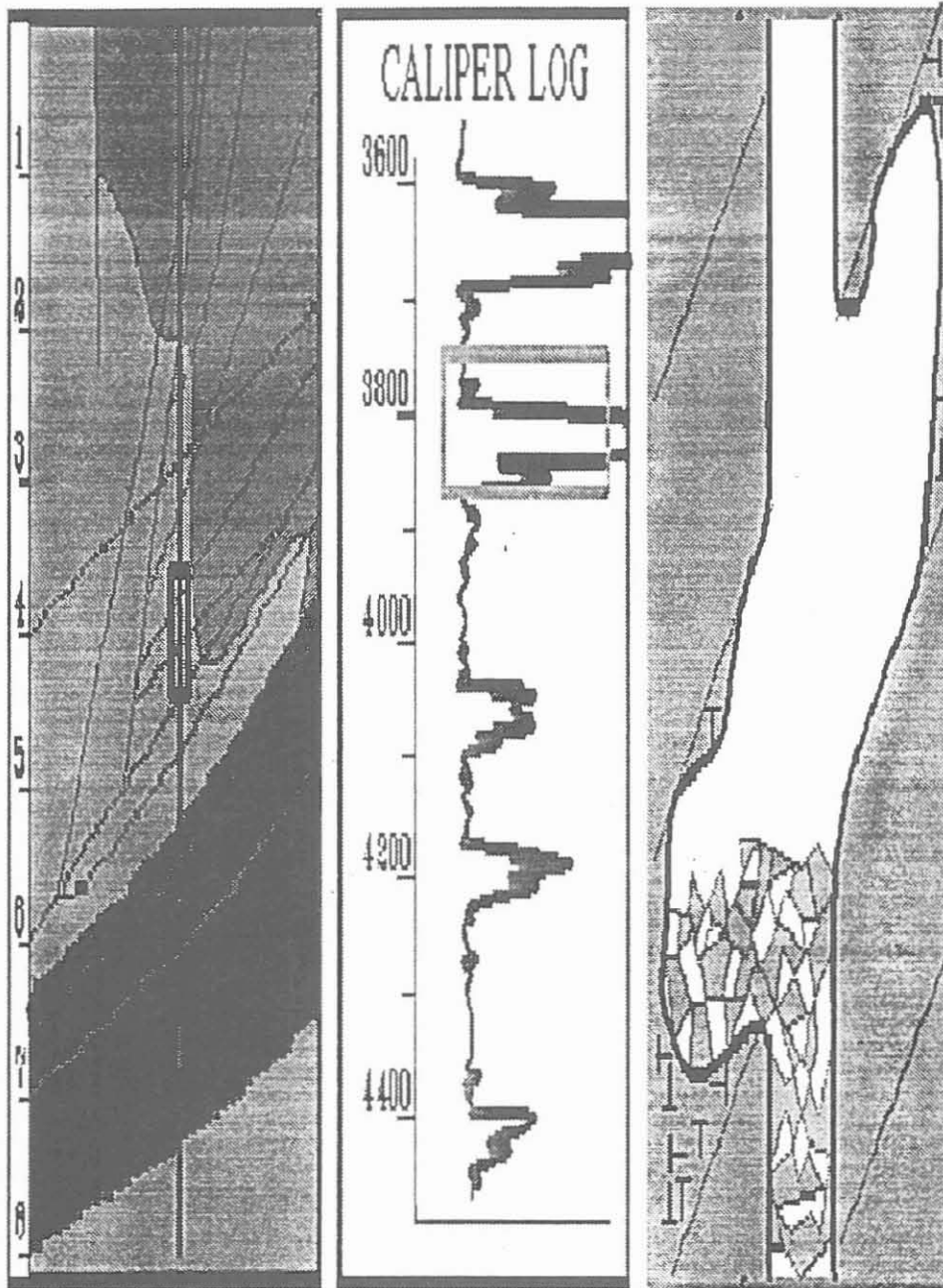
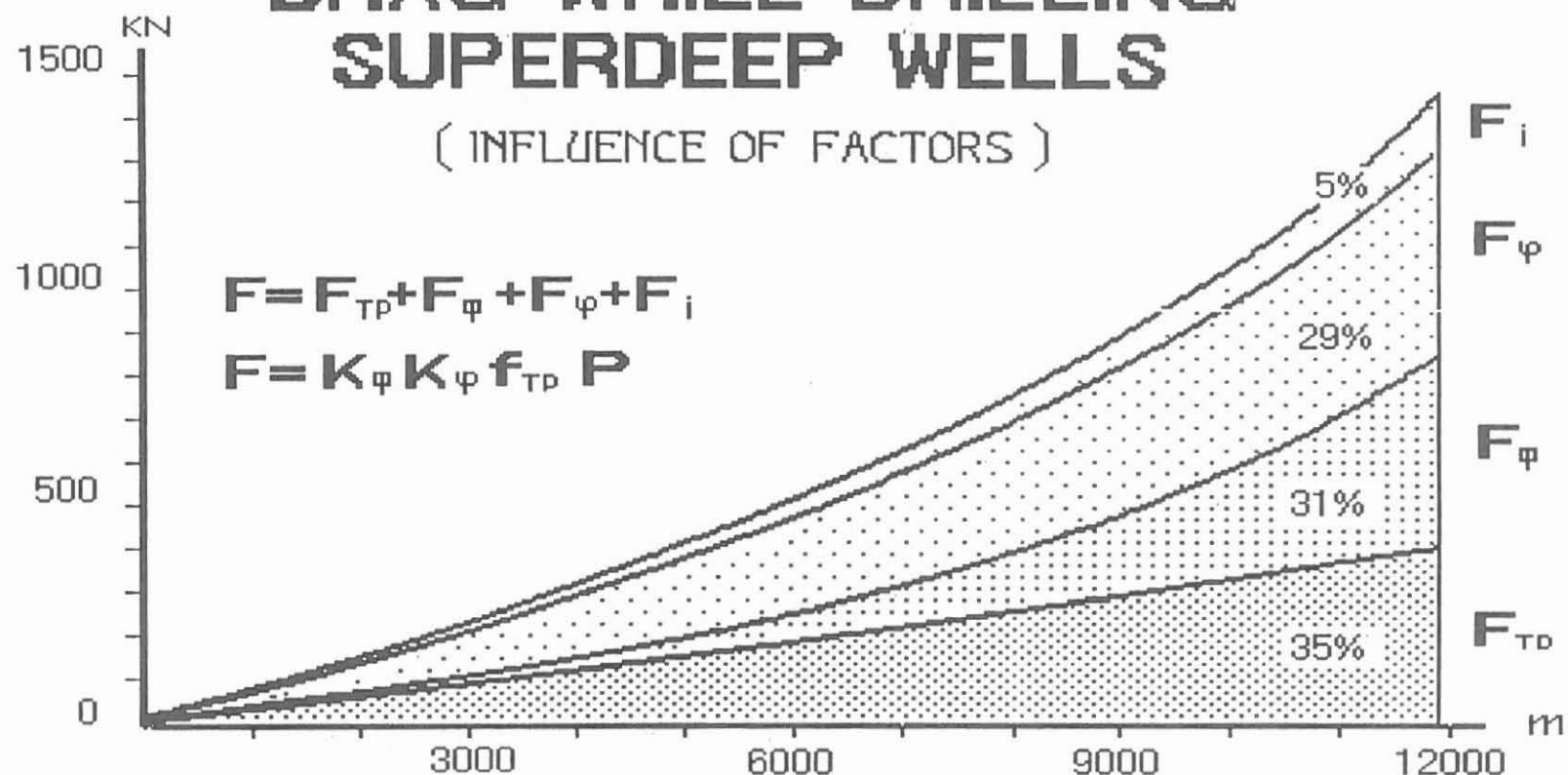

FIG. 3

DRAG WHILE DRILLING SUPERDEEP WELLS

(INFLUENCE OF FACTORS)



Friction	-	$F_{TP} = f_{TP} P$	$f_{TP} = 0.25 - 0.4$
Cross-section shape	-	$F_{\varphi} = f(K_{\varphi})$	$K_{\varphi} = \frac{1}{\cos \beta} = 1 - 3$
Spatial inclination	-	$F_{\psi} = f(K_{\psi})$	
F_i - others			$\cos \Delta \varphi = \cos \alpha_K \cos \alpha_H + \sin \alpha_K \sin \alpha_H \cos \Delta \psi$

FIG. 4

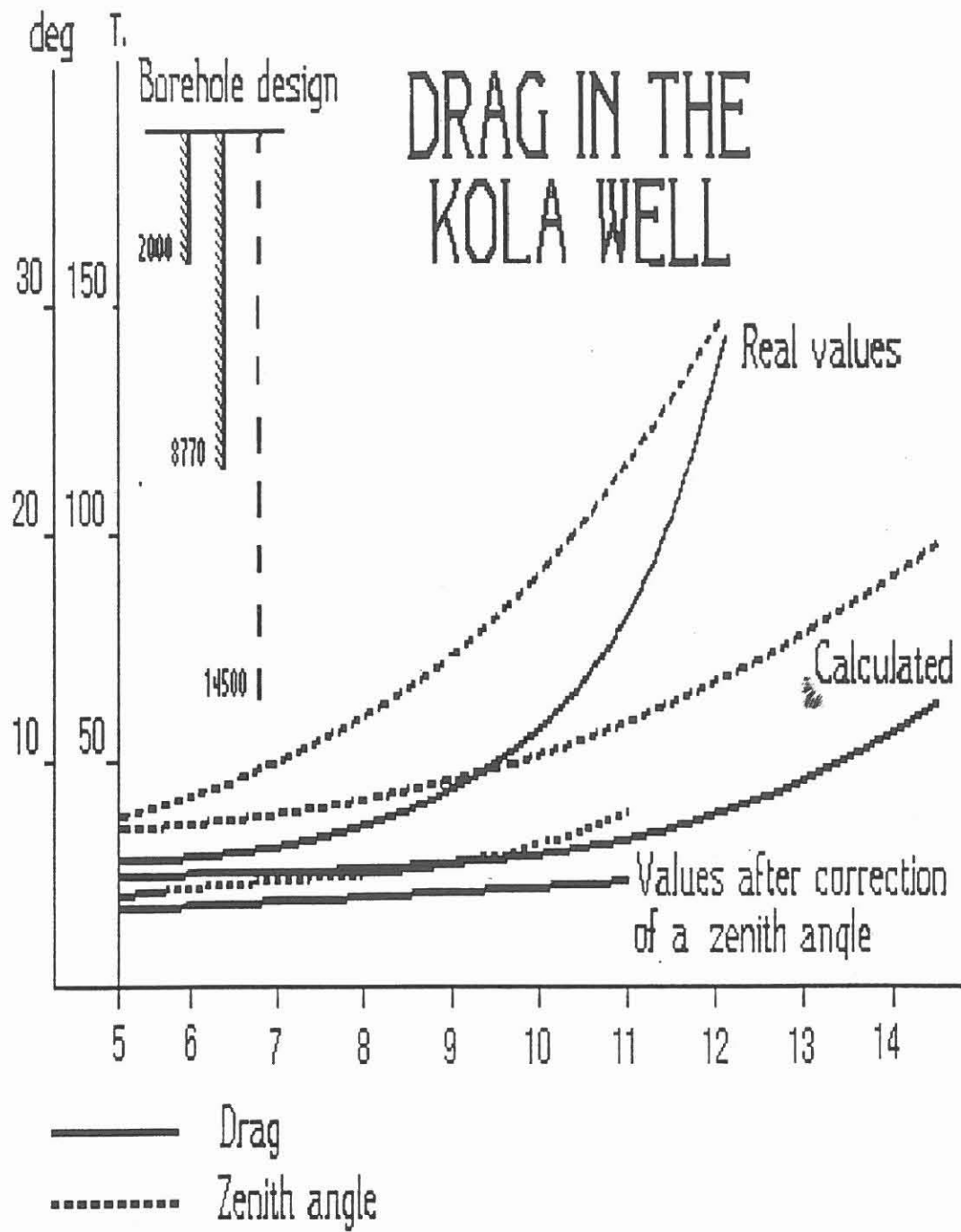

FIG. 5

THE RESULT OF ADOPTION OF THE MAIN CONCEPTS OF DEVIATION CONTROL IN DRILLING OF THE SG-3 EXPERIMENTAL BOREHOLE

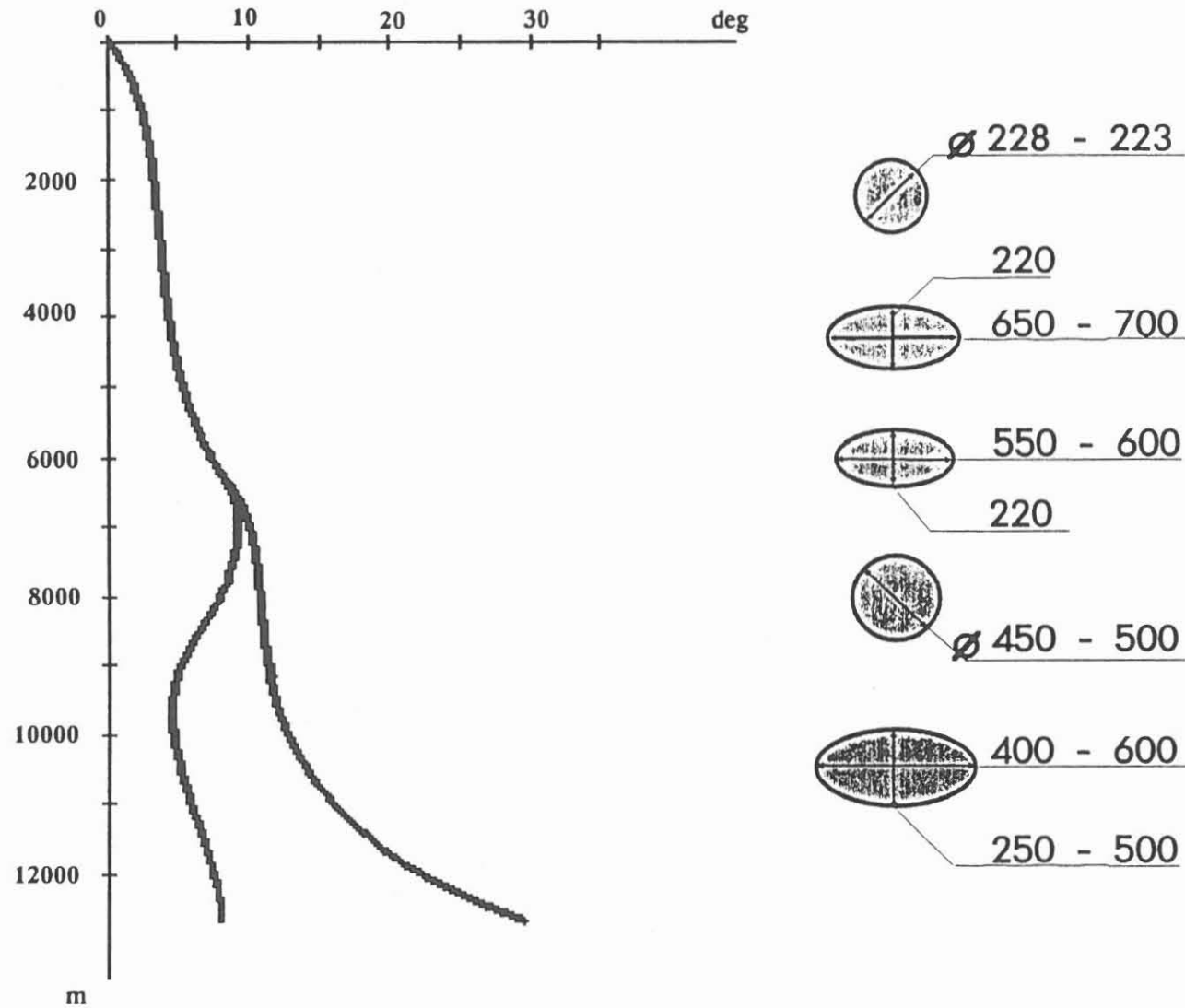

FIG. 6

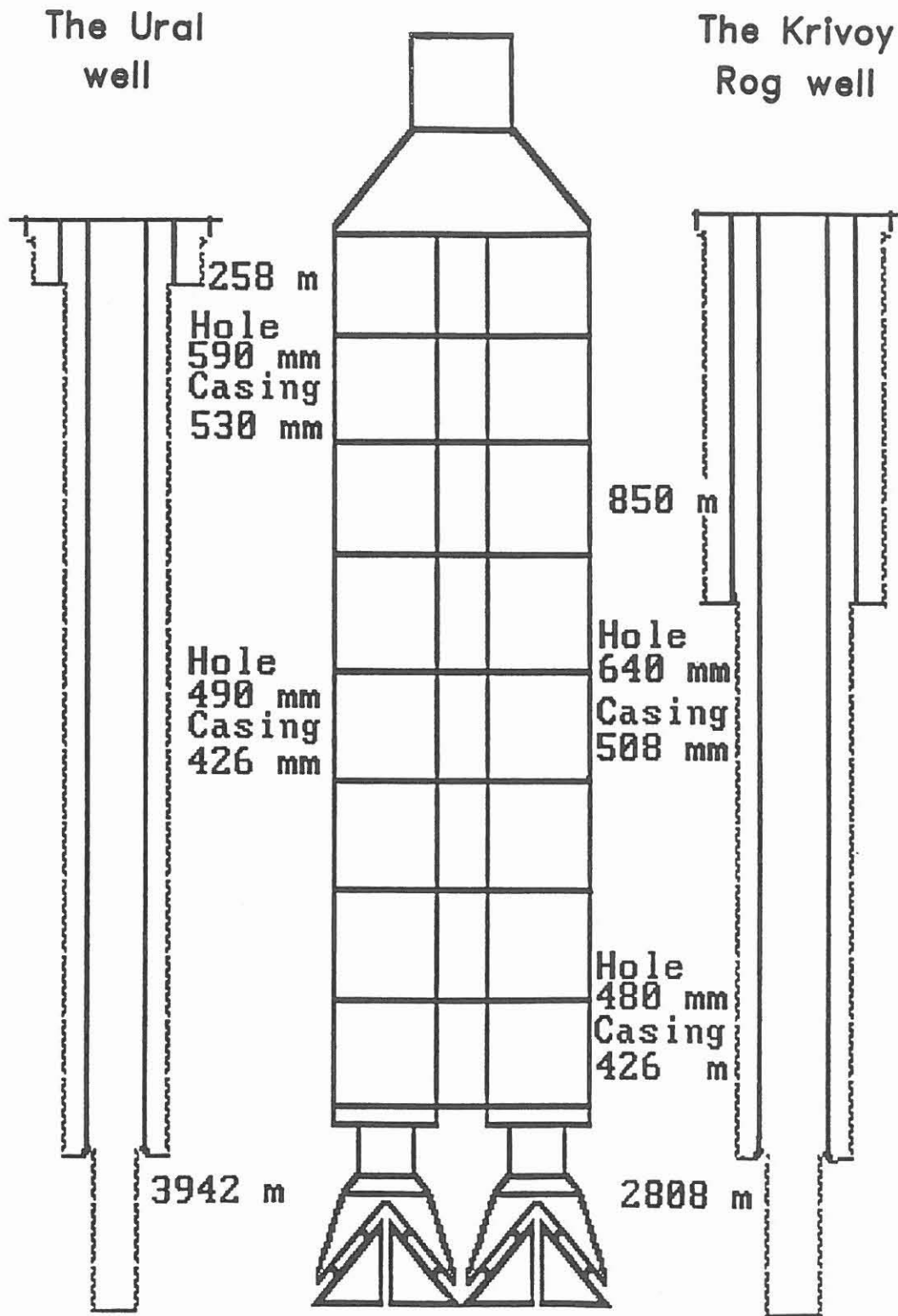

FIG. 7

INFLUENCE OF CROSS-SECTION SHAPE AND BOREHOLE INCLINATION ON DRAG

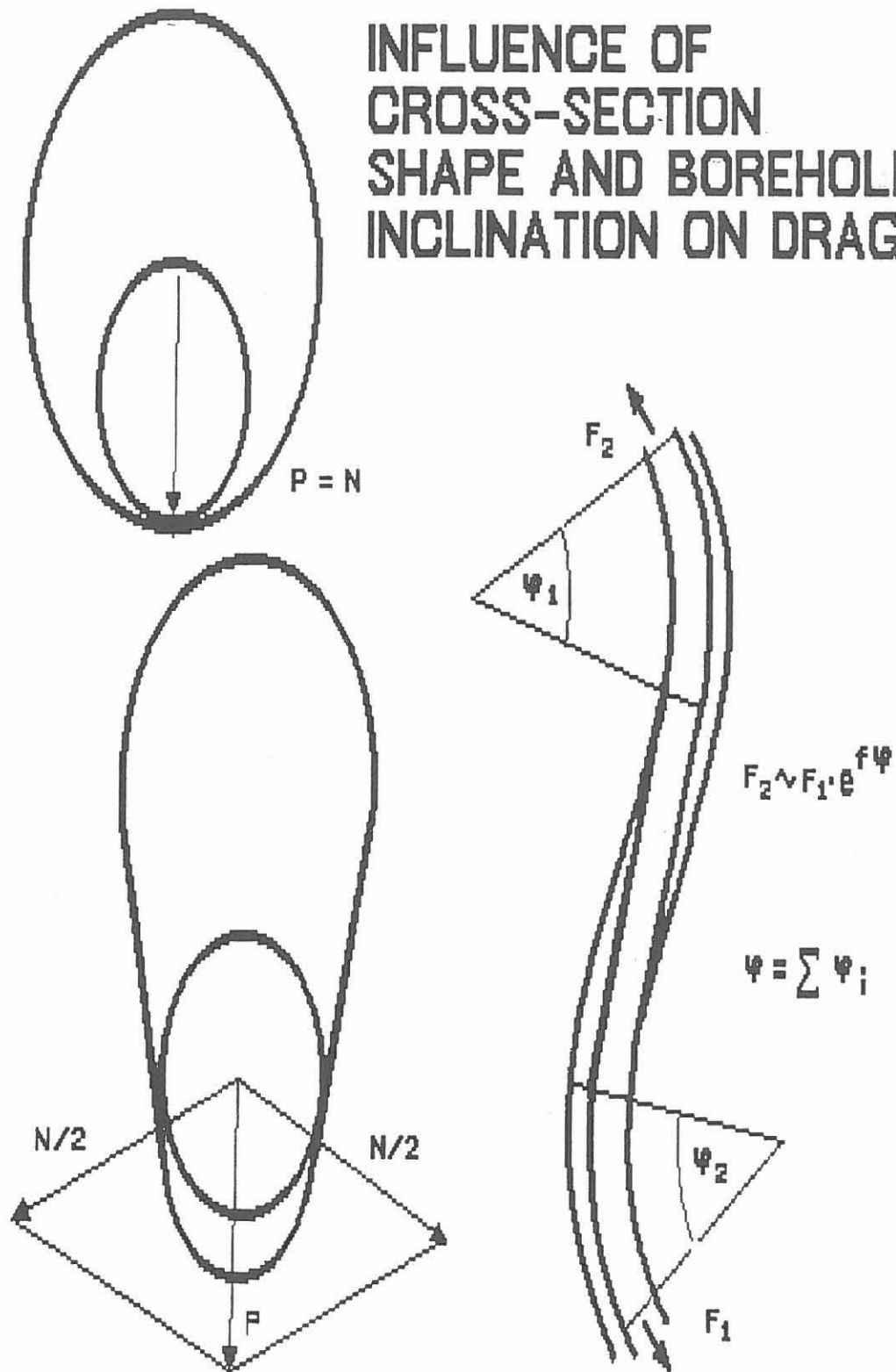

FIG. 8

DECREASE OF PIPE WEIGHT IN DRILLING MUD

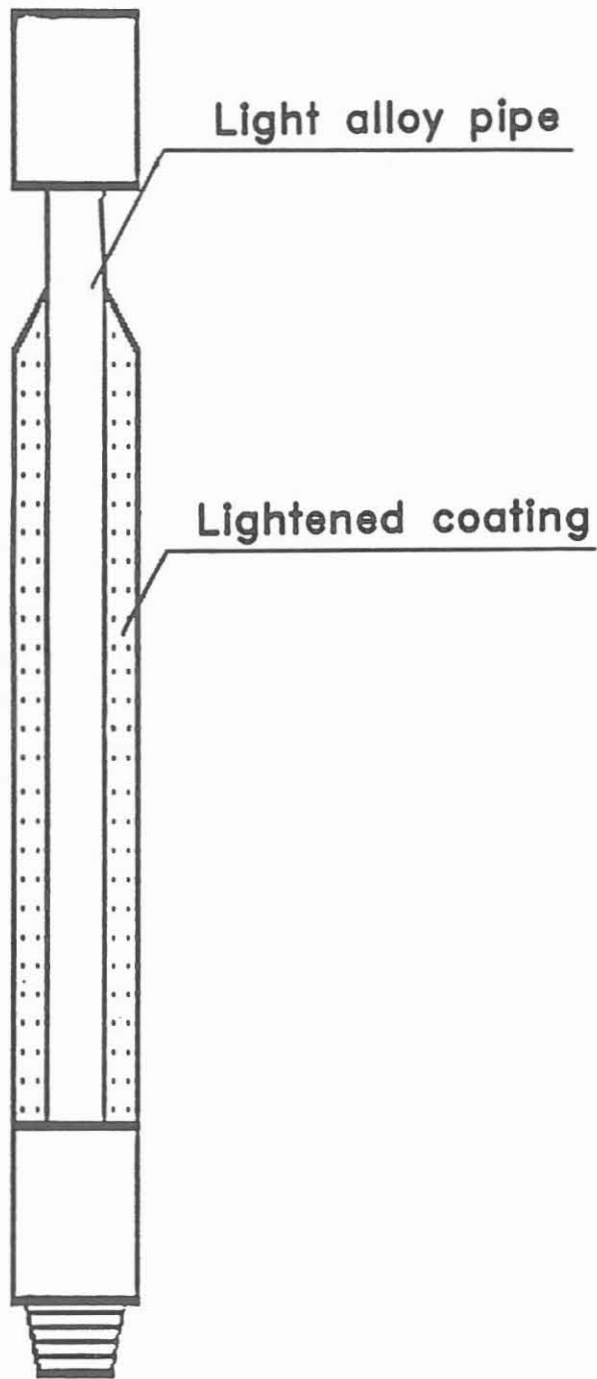
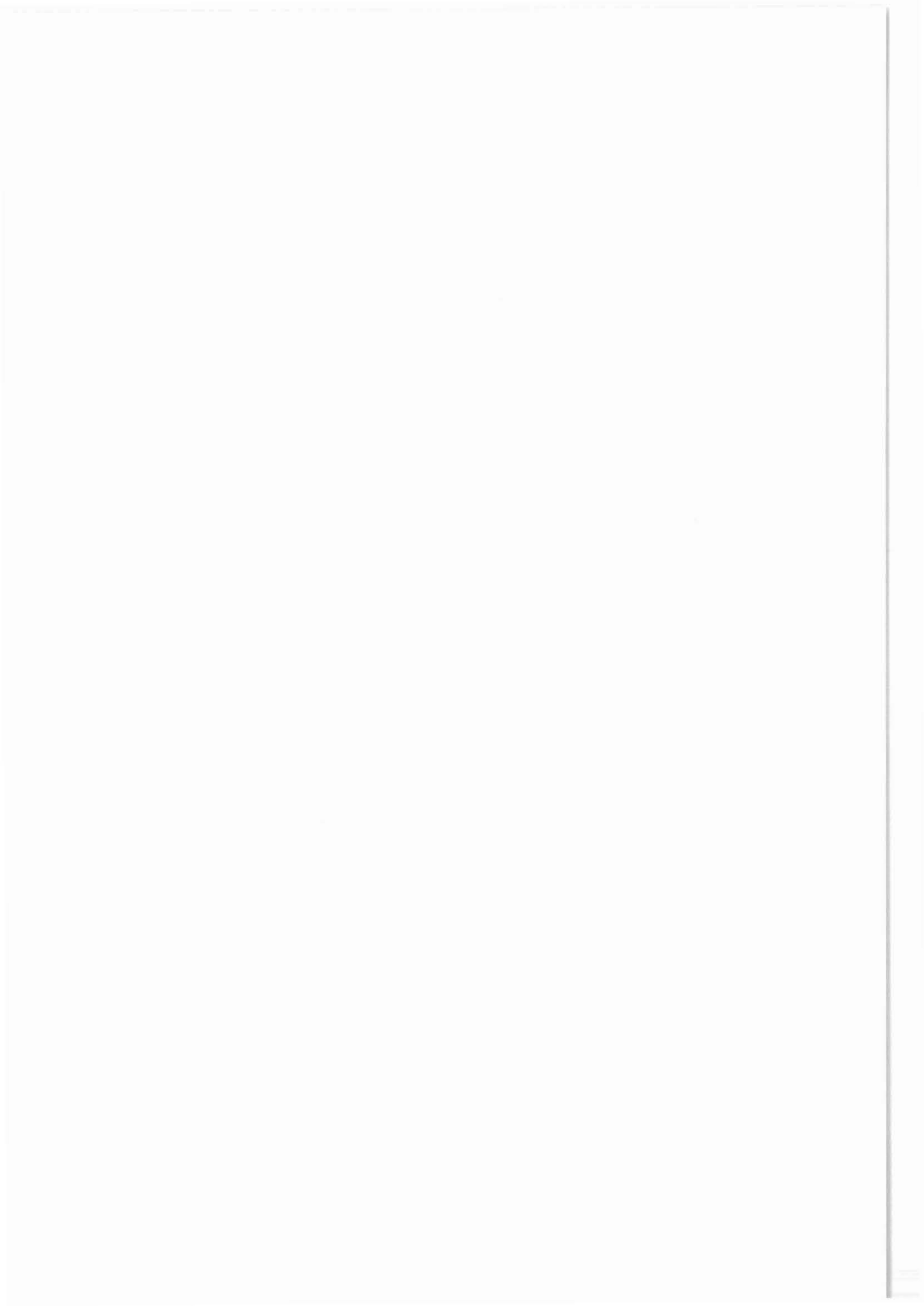

FIG. 9

Requirements for borehole verticality in superdeep drilling

V. S. Basovitch

NEDRA Company
17, Jubileinaya ul.,
Zapoliarny of Murmansk Region
Kolskaya GRES / CIS



REQUIREMENTS FOR BOREHOLE VERTICALITY
IN SUPERDEEP DRILLING

V. BASOVICH - the Deputy Director on Scientific Work of
the Scientific and Production Centre "KOLA SUPERDEEP"

The necessity for borehole verticality maintenance while drilling the superdeep boreholes in crystalline rocks is known. In the first instance, this is resulted in problem of reducing the resistance forces during the tool displacement and rotation, reducing of drilling string and casing wear, facilitating the casing running and so on.

It is necessary to estimate the critical values of the deflection angle of deviation and exactly in these limits it is required to support the borehole verticality.

Let us study the mechanism of geological and petrophysical rock properties influence upon the borehole deviation and the necessary conditions for deviation control. In Fig. 1 it is schematically shown the lower part of the bottom-hole assembly and the action of the resulting and deflecting effort P_g , that taking into account the integrated influence of such geological factors as the angles of bedding, their anisotropy, the change of rock strength properties, fracturing and so on. This geological deflecting effort P_g affects the bottom-hole assembly, causing the destruction of tool (the bit) deflection and the borehole deflection from the vertical. The active force P_t , counteracting the force P_g must be applied to maintain the borehole within the controlled deviation limits. The processing of statistic data on drilling of Kola multiple sidetracks shows, that when producing the counteracting technological effort P_t on the drill bit within the range of 0,25-0,27 kH, there are no counteraction problems towards the geological deflecting effort even in the worst, from the point of view of deviation increase, conditions. Thus, while redrilling the borehole SD-3 in interval 7000-8770 m with the drill bit 295 mm in diameter, when P_t amounted to 0,25 kH at deviation control. In the first instance, this is explained by the large specific mass of bottom-hole assembly within the size. One would think that under such bottom-hole assembly parameters while drilling the geological intervals with the less deviation influence, it should occur an abrupt decrease of deviation at the expense of excess P_t over P_g . But such

factors do not take place because P_t depends on the bottom-hole assembly angle of inclination ($\cos \alpha$) and when the slight angle decrease happens, P_t has the sharp decrease and vice versa. Thus, such system^t is working under the conditions of self-adapting equilibrium system when the inclination angle is changing in the range of 1-2 degrees.

The stabilization of the borehole deviation at range of 5-6 degrees is the most optimal one, because at these angles the pressing loads towards the borehole wall are small and they do not promote the great increments of the resistance forces. The decrease of the stabilization angle of deviation can result in the substantial expenses in case of performing the new sidetrack. The experience of spudding of more than 10 sidetracks in the Kola borehole more than 4 degrees, the bench running and the following drilling of the sidetrack are successfully realized without cementing the abandoned borehole and without the installation of the special deflecting tools. It serves the major proportion of time and means.

The most complex thing is to stabilize the borehole deviation within the pointed limits while drilling with the drill bit of less diameter. Thus, in drilling with the drill bit of 215 mm in diameter and the bottom-hole assembly 195 mm in diameter and the borehole deviation of 5 degrees, the load P_t , counteracting the deviation, constitutes only 0,1 kH. Taking into account such counteraction it is difficult to control the geological deflecting effort. In this case, under the downhole engine shaft is used the suspension of concentrated mass, that besides the increasing of static pressing effort, exerts the dynamic component of load, thereby promoting the efficiency of borehole wall destruction against the deviation direction. As the suspension mass are used the spiral drill collars, the ellipse-like drill collars and so on. For all this the most important thing is to obtain information on the borehole deviation origin in order to replace the bottom-hole assembly for the more active one. For this purpose it is developed and successfully applied the downhole indicator showing the excess of limiting angle of deviation. When the downhole deflection angle is increasing by one degree, the signal is formed at the surface, that becomes the necessary condition for pulling out the drilling tool and the bottom-hole assembly replacement.

The most complex problem to control the borehole deviation is the environment in drilling the tectonic shear zones with the formation of large cavities. The illustration of this

problem is given in Fig. 2. In this situation it is very important to know the mechanism of cavity formation. On the basis of the Kola superdeep borehole drilling one may suppose that the cavities have been formed in the drilling process as a result of rock breakdown. The indirect factors confirm this phenomenon when in the process of breakdown of the tectonic shear zones we observe at the surface the increased slime recovery and by conducting the geophysical investigations just after the drilling of such an interval, the devices run into downhole without meeting any slime cushions. In this case, by cavity extent up to 15 m (the straight bottom-hole assembly, diameter 195 mm and the deflection angle 5 degrees are valid). Fig. 2a do not occur extra deviation problems, but in case the cavity extent is more than 15 m (Fig. 2b), the support components do not execute their functional purpose, the bottom-hole assembly is bending under the action of its own load component and it is losing its straight form, thus giving the orientation to the drill bit for sharp deviation increase. At such a situation it is necessary to define timely the moment, when the bottom-hole assembly loses its straight form, in order to replace it for the assembly with the hinge element in the upper part in order to share the vertical effect and the operation onto the "lying" borehole wall at the cavity bottom. The loss of the straight form of the bottom-hole assembly is defined in the process of drilling with the help of indicator showing the limiting deviation angle increase that is installed over the drilling bit.

Taking into account the advantages connected to the employment of the active systems for borehole deviation control and estimating the experience of their utilization while drilling the superdeep borehole KTB, we consider that such systems have a number of disadvantages that limit the opportunity of their utilization in drilling the superdeep boreholes in crystalline rocks.

In the first instance, the following disadvantages are:

1. Not favourable operating reliability (as for the KTB borehole: 23 runs from 50 were unsuccessful).
2. The limitation of utilization under high temperatures.
3. It is impossible to utilize the active systems in the cavernous zones of the borehole, that are impressive in the lower intervals of crystalline rock (the detailed information is not available for us but we imagine that

the KTB borehole had a sharp deviation increase in interval 5519-5596 m and its main reason was the drilling in the cavernous zone).

4. The construction complexity and the high operational expenses.

MAIN CONCLUSIONS:

1. For drilling the upper intervals of the superdeep borehole of nominal diameter, where the demands towards the borehole verticality are very high, it is expedient to employ the active control systems ZBE 5000 or VDS 3 that are applied at KTB.
2. In drilling the borehole intervals of increased cavernosity and the lower intervals with high temperature it is necessary to apply the technology and technical facilities having been developed in the Scientific and Production Centre "Kola Superdeep", including:
 - 2.1 The indicator to run into limiting borehole deviation in order to estimate the deviation causes (the geological one or the loss of the bottom-hole assembly balance),
 - 2.2 The collection of components of the lower part of the bottom-hole assembly in order to control the pressing bit load towards the borehole wall including the exerting of the dynamic loads for increasing the efficiency of the borehole wall destruction.

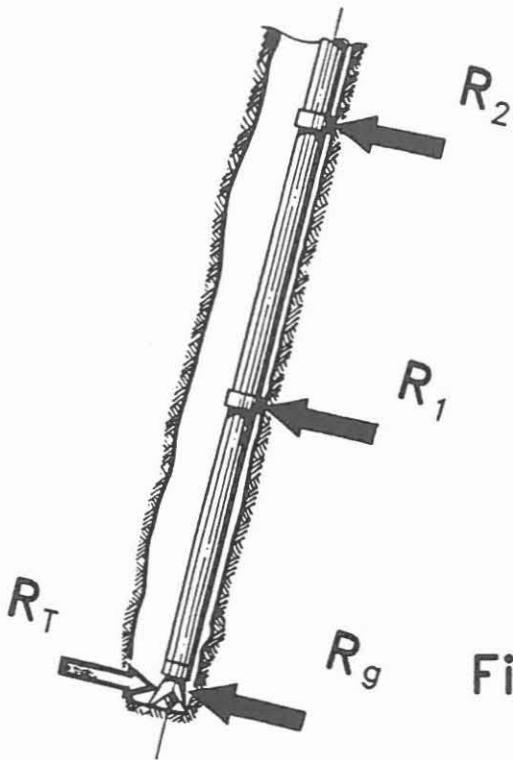

Fig. 1 Action Scheme of Deflecting Loads upon the BHA

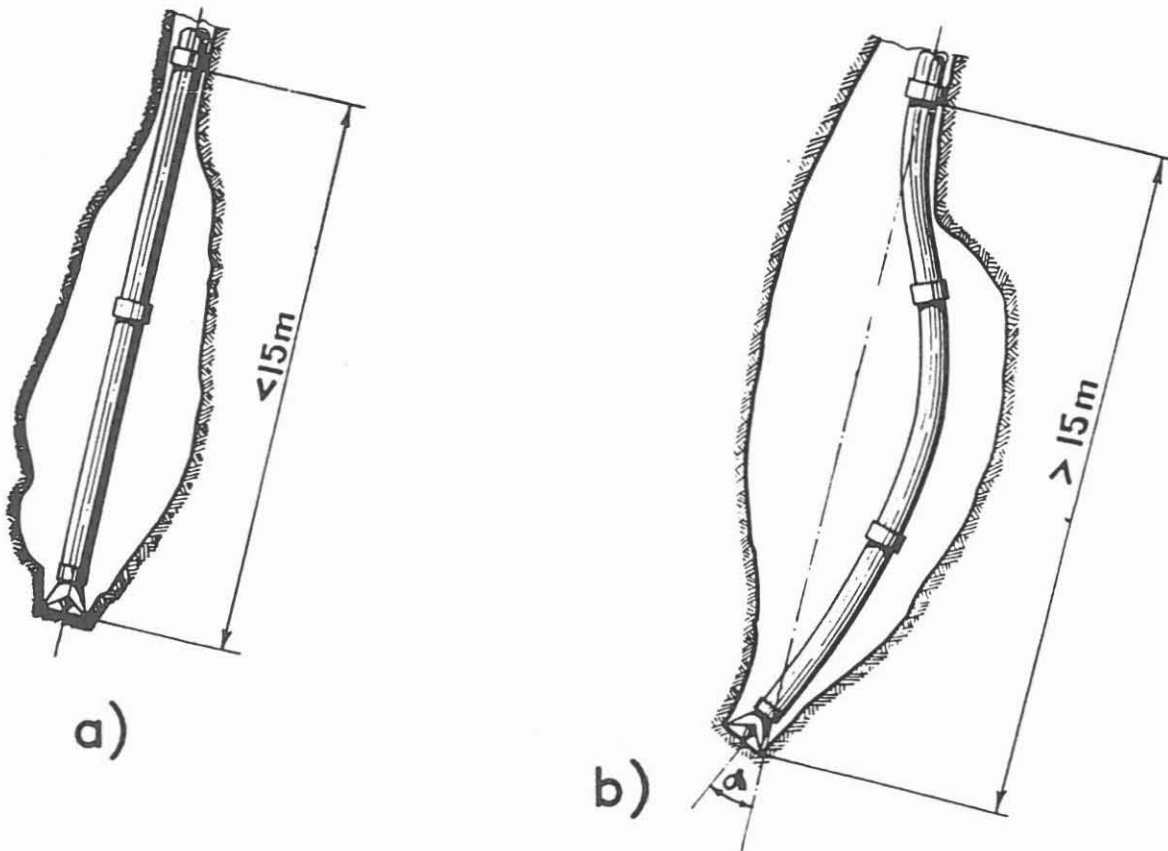
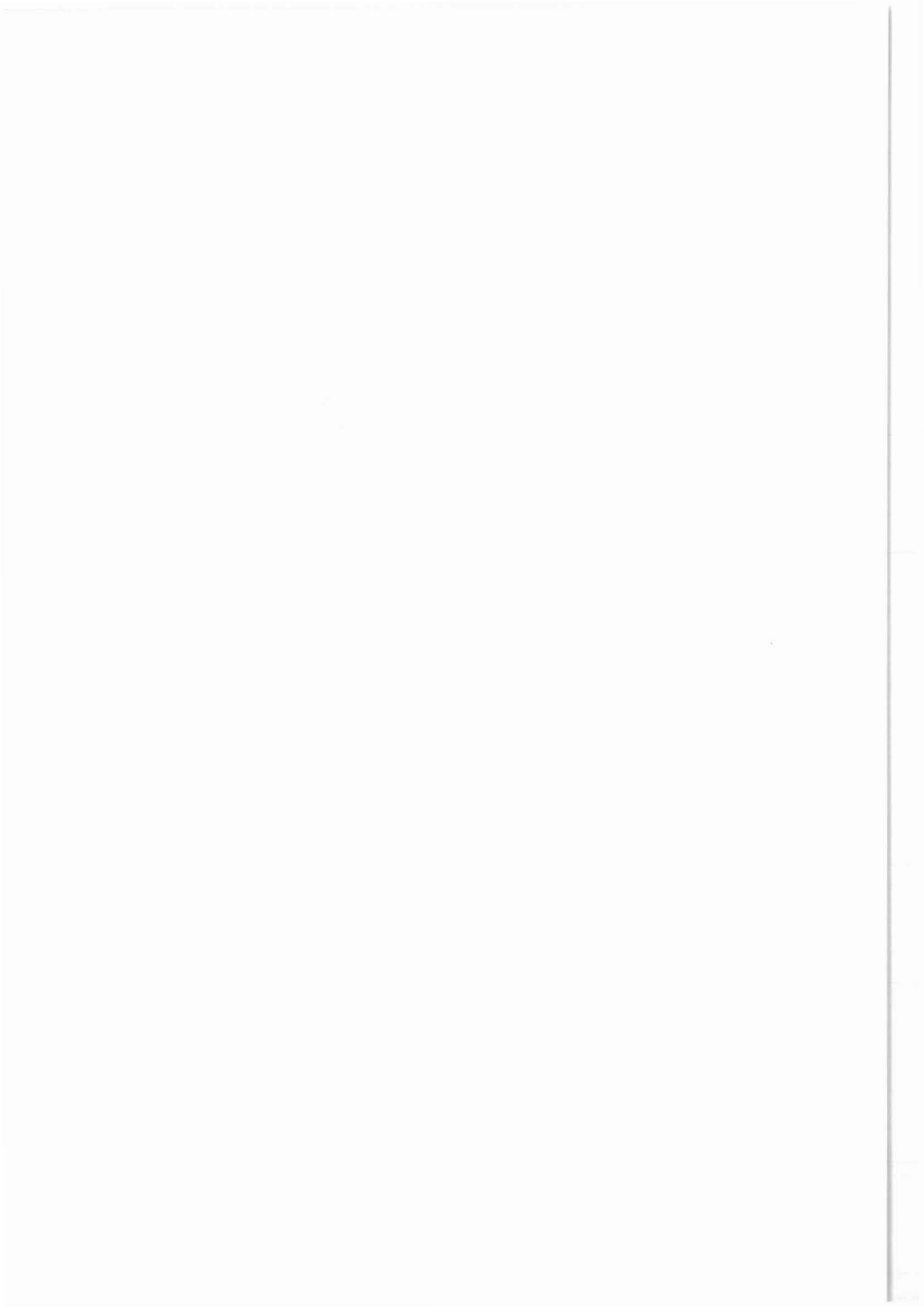

Fig. 2 Borehole Deviation Mechanism while Drilling the cavernous zones

**High temperature experiences and developments
in geothermal drilling in Kakkonda, Japan**

S. Saito

Japan Metals & Chemicals Co., Ltd.
JMC Bldg.
No. 8-4 Koami-Cho, Nihonbashi
Chuo-Ku, Tokyo / Japan 103



High Temperature Experiences and Developments in Geothermal Drilling in Kakkonda, Japan.

Seiji SAITO
Japan Metals & Chemicals Co. Ltd.,

Forty years have passed since the first geothermal exploration well was spudded in Japan. Since then more than 470 geothermal wells, a total drilled length of about 600 km were drilled by Japanese geothermal developers in 14 areas (Fig. 1). By 1977 and 1982, well depths had reached 2,000 m and 3,000 m respectively. A total of seventy 2,000 m wells and six 3,000 m wells have been drilled today. The deepest well, at 3,206 m with a maximum temperature of 270 deg.C (Figs. 2 and 3), was drilled by New Energy and Industrial Technology Development Organization (NEDO) as a test well in Hohi district of northern Honshu Island. The maximum recorded well temperature was 373 deg.C in Fushime, southern Kushu Island. To introduce recent deep well technologies in Kakkonda, northern Honshu Island, well K6-3 drilling story is described; that mainly focuses on high temperature drilling technologies.

K6-3 was drilled in Kakkonda, by Tohoku Geothermal Energy Co. Ltd. under the technical supports of Japan Metals & Chemical Co. Ltd., as a production well for the Kakkonda No.2 power plant (Figs. 4 and 5); that will be operational in 1996. Initially in Kakkonda, about 70 wells with depths ranging from 1,000 to 2,000 m depths were drilled and geothermal fluids were tapped from a tertiary formation (Table 1). But recently three deeper wells were drilled into a pre-tertiary formation and neo-granitic rocks (Fig. 6). These wells discovered a deeper promising reservoir. The planned depth of K6-3 was 2,800 m but it was deepened to 3,000 m when a fracture zone was found at 2,764 m (Fig. 7). It took 180 days to drill from spud in to TD (Fig. 8). This included 33 days for lost circulation treatments in the shallower depths and 27 days for 15 trajectory correction runs with downhole motors. A total of 56 drill bits were needed to reach TD (Fig. 9). Retrievable type MWD (ANADRILL SLIM-1), with a temperature limitation of 150 deg.C, was first employed for the high temperature geothermal well at the depth range of 1,531 to 2,245 m, where the formation is over 330 deg.C. Twenty-seven MWD runs were recorded for both downhole motor drilling and rotary drilling (Table 2). Total operating time was about 300 hours and total downtime was 13 hours; which was mainly due to battery parts failures. Two cooling towers and a 500 kl cooling pit were used to cool the returned mud (Fig. 10). These systems worked well, but the stator rubbers came off for the downhole motors used at about 2,198 m and 2,245 m depths (Table 3, Fig. 11). Below that depth, only rotary packed assemblies with long blades stabilizers were employed to keep the trajectory as straight as possible. Low content bentonite muds with high temperature dispersant and lubricant were used as a drilling fluid (Table 4). Various temperature data were taken, such as temperature logging at TD, logging at 2,200 m before running 9 5/8" liner, mud temperature in and out of the well, mud circulation temperature recorded by MWD, and bottom hole temperature recorded by thermometers installed on top of the magnetic single shot tool (Fig. 12). The following results were found:(a) Even if the formation temperature is 350 deg.C drilling fluids can be cooled with proper cooling system and bottom hole circulation temperature (BHCT) can be kept about 80 deg.C in a 12 1/4" hole. (b) Even when pumping colder mud BHCT increased very much for the 8 1/2" hole. This is maybe because of decreased pump rate for the 8 1/2". (c) The BHCT decreased drastically while drilling with lost circulation.

Acid fluids were expected for this well, so a duplex tieback casing was installed from surface to 400 m depth.

The NEDO 4,000 m test well is planning to drill from the same drilling pad as K6-3 well (Fig. 13). It will be spudded in December 1993 and will reach TD. in 1996. Various tests are planned including casing corrosion tests while producing geothermal fluids at about 3,000 m and TD.

References:

- Kato O., Doi N., Muramatsu Y. (1993) Neo-Granitic Pluton and Geothermal Reservoir at the Kakkonda geothermal Field, Iwate Prefecture, Japan. *Journal of the Geothermal Research Society of Japan*, Vol.15, No1, 41-57.
- Kimbara K. (1988) Geothermal Resources in Japan, Geothermal Field and Geothermal Power Plants in Japan. *International Symposium on Geothermal Energy, Kumamoto and Beppu, Japan*. November 10-14, 1988, 35-42.
- Saito S. (1993a) The Drilling Experience of K6-2, the High-Temperature and Crooked Geothermal Well in Kakkonda, Japan. *ASME Journal of Energy Resources Technology*, 115, 117-123.
- Saito S. (1993b) The Status of Deep Geothermal Well Drilling in Kakkonda, Japan. *Journal of the Japanese Association for Petroleum Technology*, 58, 351-362.
- Saito S. (1993c) The Status of Geothermal Well Drilling in Japan. *Journal of the Geothermal Research Society of Japan*, (under printing).
- Sasada M., Miyazaki S., Saito S. (1993) NEDO's Deep-Seated Geothermal Resources Survey at the Kakkonda System, Northeast Japan. *Trans. Geotherm. Resour. Counc.* 181-185.

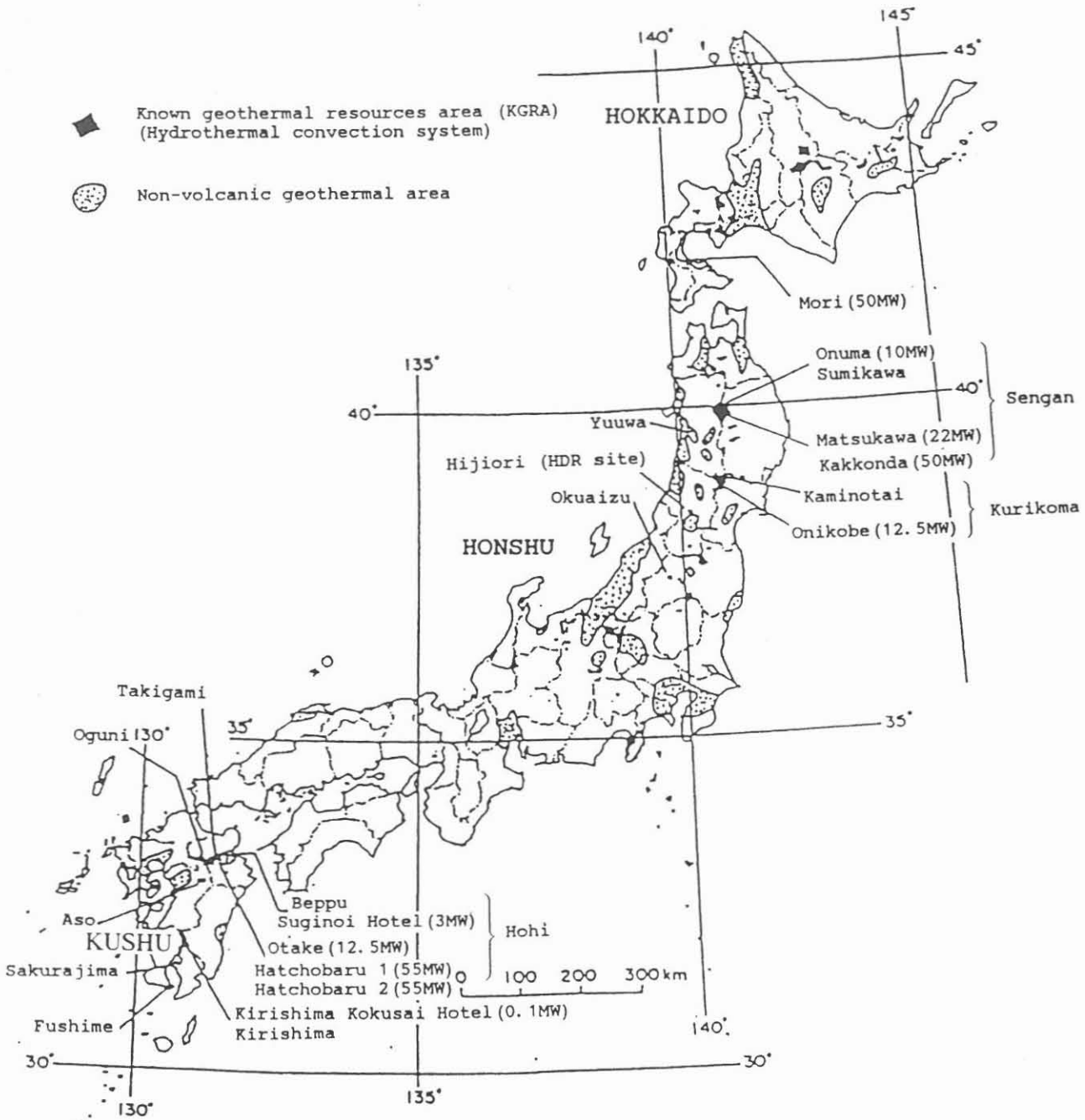

Fig. 1. Distribution Map of Geothermal Power Plants and Geothermal Areas in Japan(modified after Kimbara, 1988).

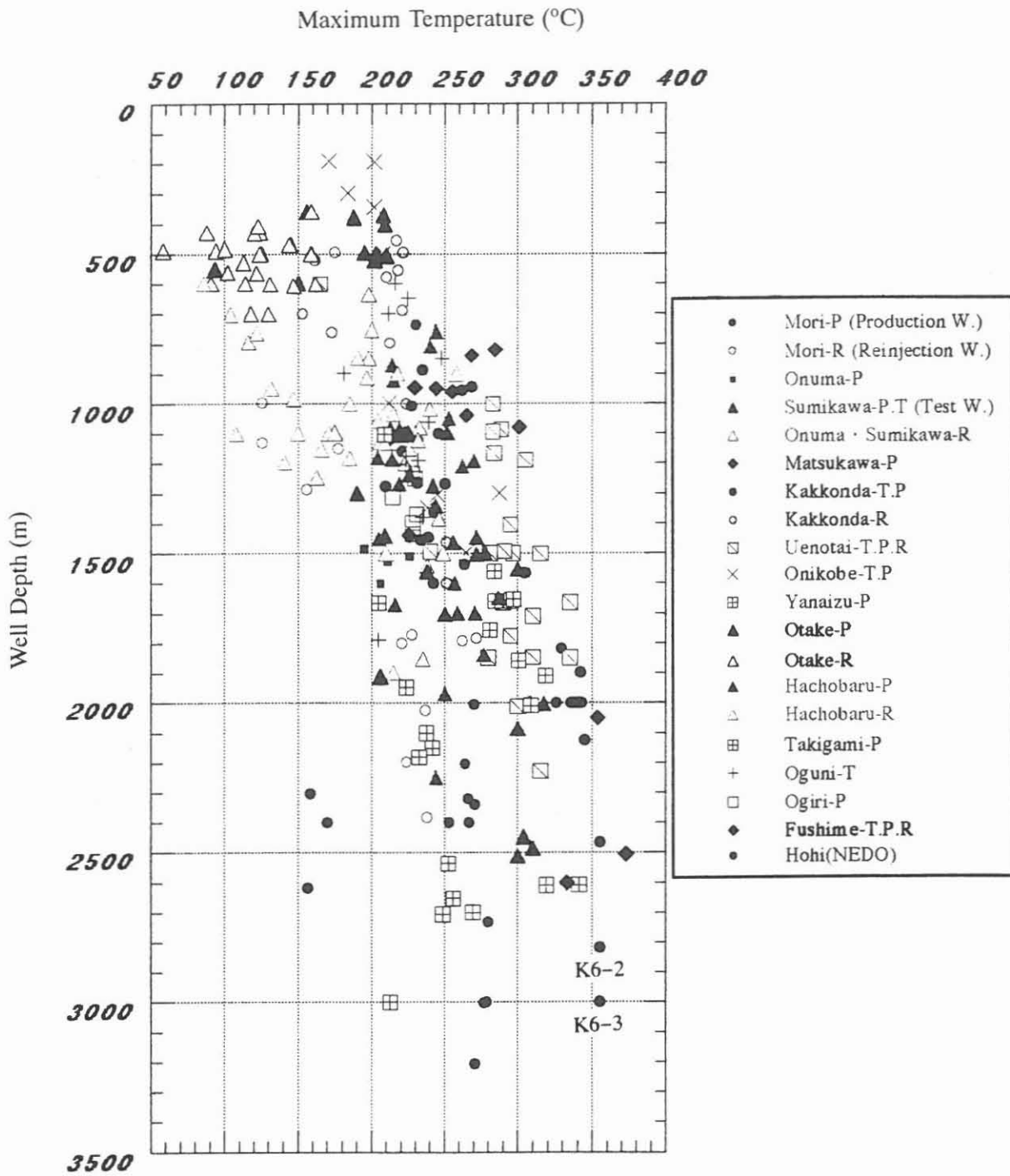

Fig. 2 Well Depths and Maximum Temperature of Geothermal Wells in Japan

(Saito,1993c)

max. temperature includes estimate max. temperature
only developers' wells are referred except 5 NEDO wells

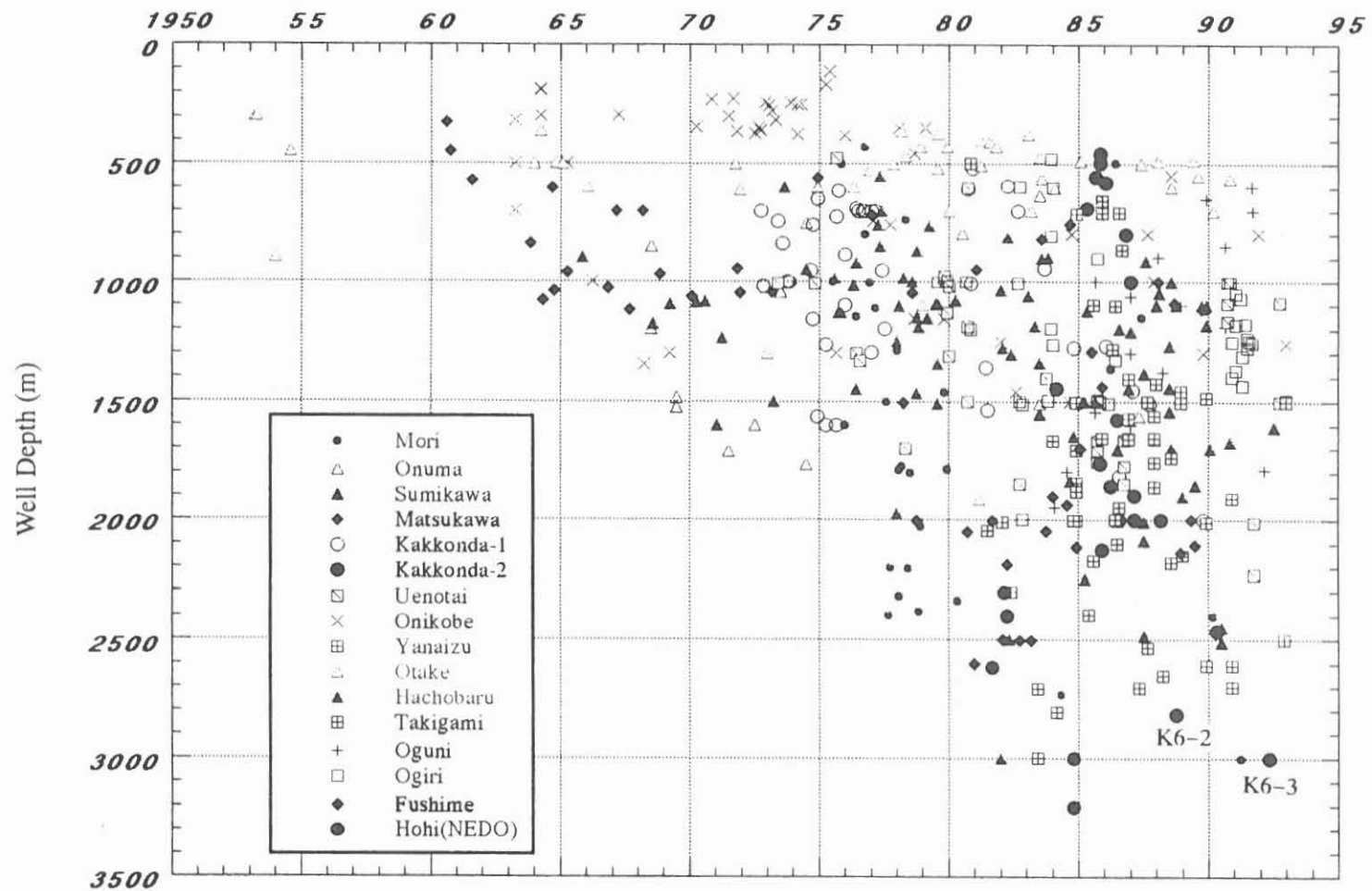
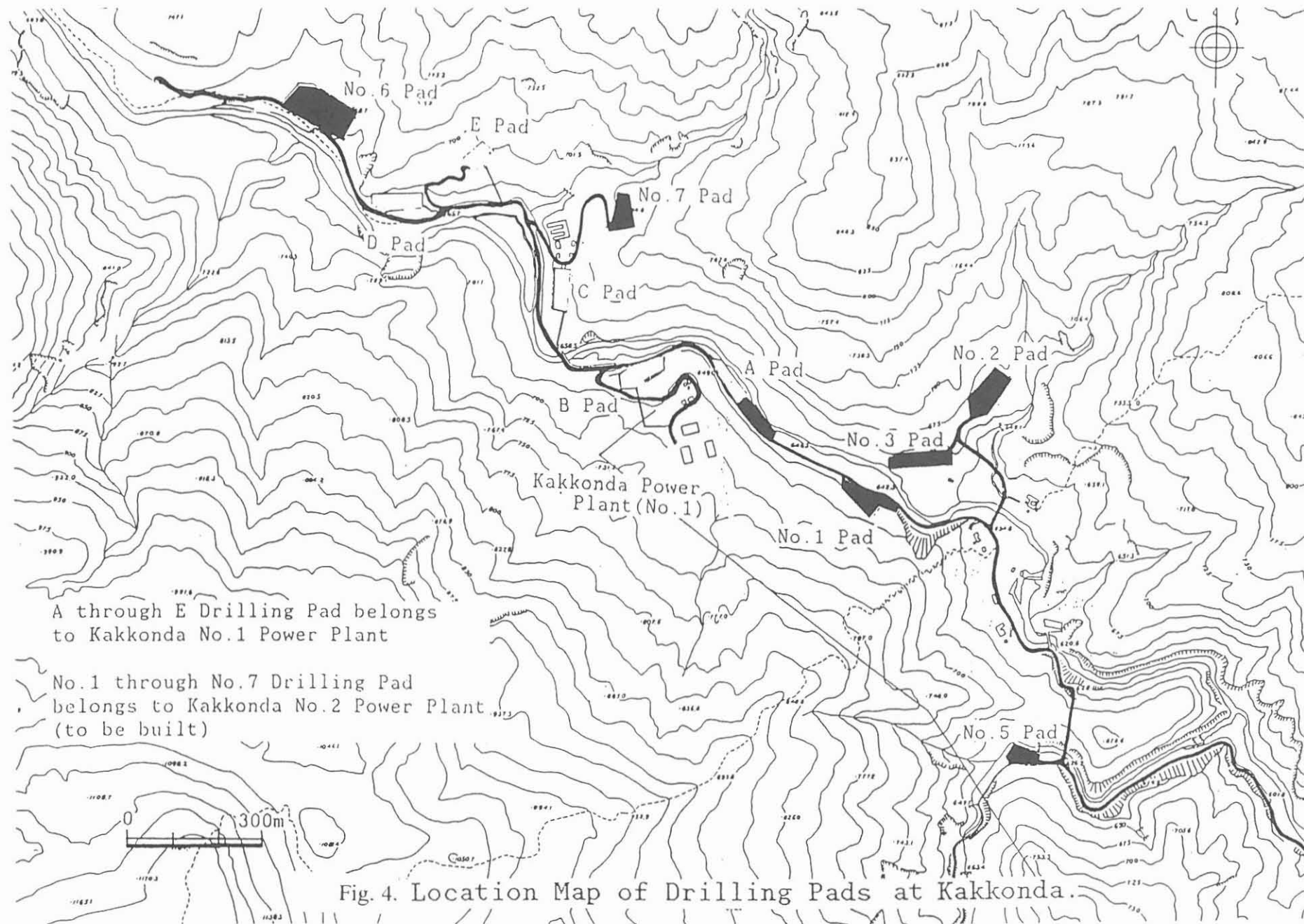

Fig. 3 The Relation between Geothermal Well Depth and Drilled Year in Japan.

(Saito,1993c)

drilled year is shown by spud year
only developers' wells are referred except 5 NEDO wells



A through E Drilling Pad belongs to Kakkonda No.1 Power Plant

No.1 through No.7 Drilling Pad belongs to Kakkonda No.2 Power Plant. (to be built)

Fig. 4. Location Map of Drilling Pads at Kakkonda.

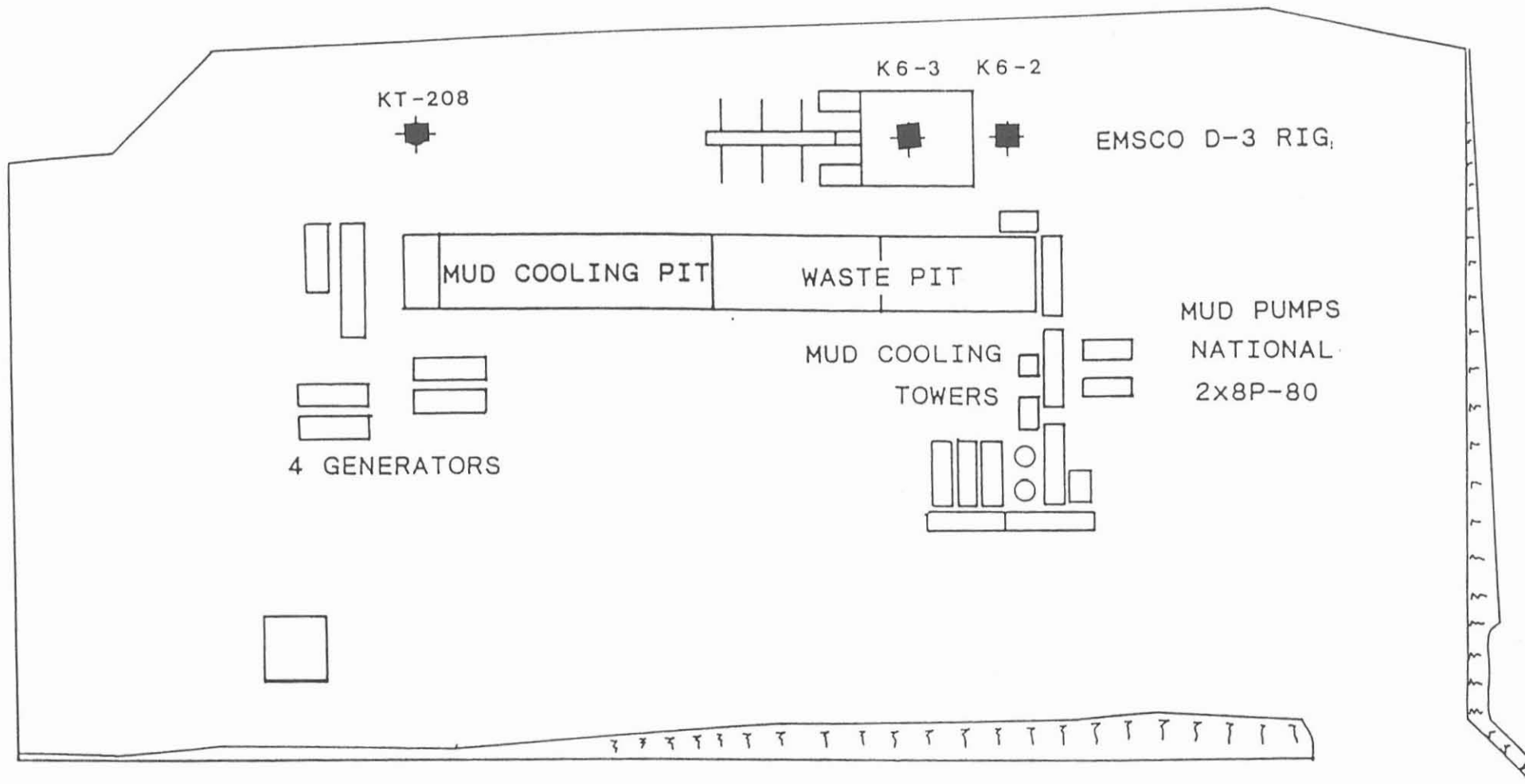

Fig. 5. K6 drill pad layout

Table 1. Chemical compositions of the geothermal fluids at Kakkonda

Well name	pH	SiO ₂	Cl	SO ₄	Na	K	Ca	Mg	Fe	Al	As	B	
		(mg/l)	(mg/l)	(mg/l)	(mg/l)	(mg/l)	(mg/l)	(mg/l)	(mg/l)	(mg/l)	(mg/l)	(mg/l)	
KA-1	8.6	415	1010	116	665	71.5	23.7	<0.01	0.03	0.33	3.78	30.8	
KA-3	8.5	435	998	111	658	72.0	21.7	<0.01	0.11	0.37	3.60	31.1	
KA-5	8.6	380	982	120	650	69.9	24.9	<0.01	0.03	0.26	3.36	30.9	
KB-3	8.5	397	983	126	674	71.9	25.5	<0.01	0.03	0.33	3.96	31.4	
KB-5	8.6	426	962	123	648	69.6	23.0	<0.01	0.04	0.33	3.09	31.4	
KC-3	8.5	401	1040	134	696	72.7	25.7	<0.01	0.06	0.34	3.04	33.6	
KC-5	8.5	401	973	121	655	72.5	24.1	<0.01	0.01	0.32	4.05	32.8	
KD-2	8.3	529	1170	118	773	86.3	20.7	<0.01	0.03	0.64	4.29	37.8	
KD-5	8.3	559	1070	128	694	92.8	23.3	0.02	0.20	0.41	4.13	35.6	
KD-6	8.3	776	1040	73.9	676	89.0	8.93	<0.01	0.01	0.75	3.98	36.2	
KD-7	8.4	549	1040	98.1	680	77.9	16.1	<0.01	0.01	0.67	3.35	32.5	
KD-8	7.2	984	1380	146	888	136	4.90	0.02	0.01	1.41	4.33	46.1	
KE-1	8.5	414	1090	132	708	77.6	32.0	<0.01	0.04	0.26	2.60	33.6	
K1-2	8.5	531	1040	98.6	676	76.6	20.5	<0.01	<0.01	0.64	3.10	30.9	
K1-3	3.6	1660	1620	136	949	204	2.96	0.22	5.79	0.39	10.5	92.6	deep well
K7-2	8.5	472	1010	93.2	660	73.3	21.5	<0.01	0.02	0.41	3.89	32.8	
K6-2	3.9	1490	1400	63.2	757	172	19.6	0.56	21.2	0.99	4.59	32.4	deep well

* 採取日 1992年12月2日 : 生産井

1989年9月25日 : K6-2

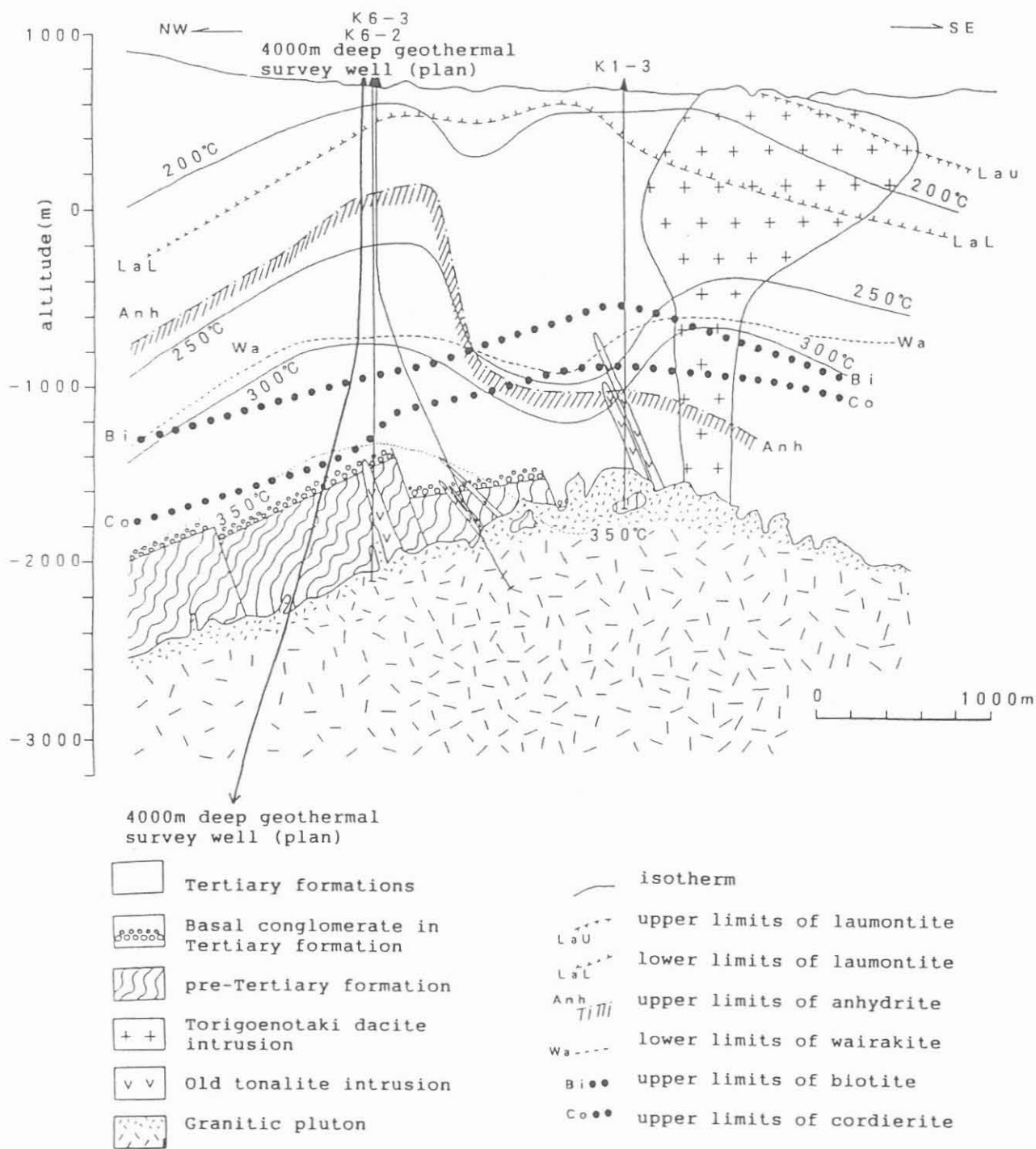

Fig. 6. Schematic geologic cross section at Kakkonda

(modified after Kato et al.,1992)

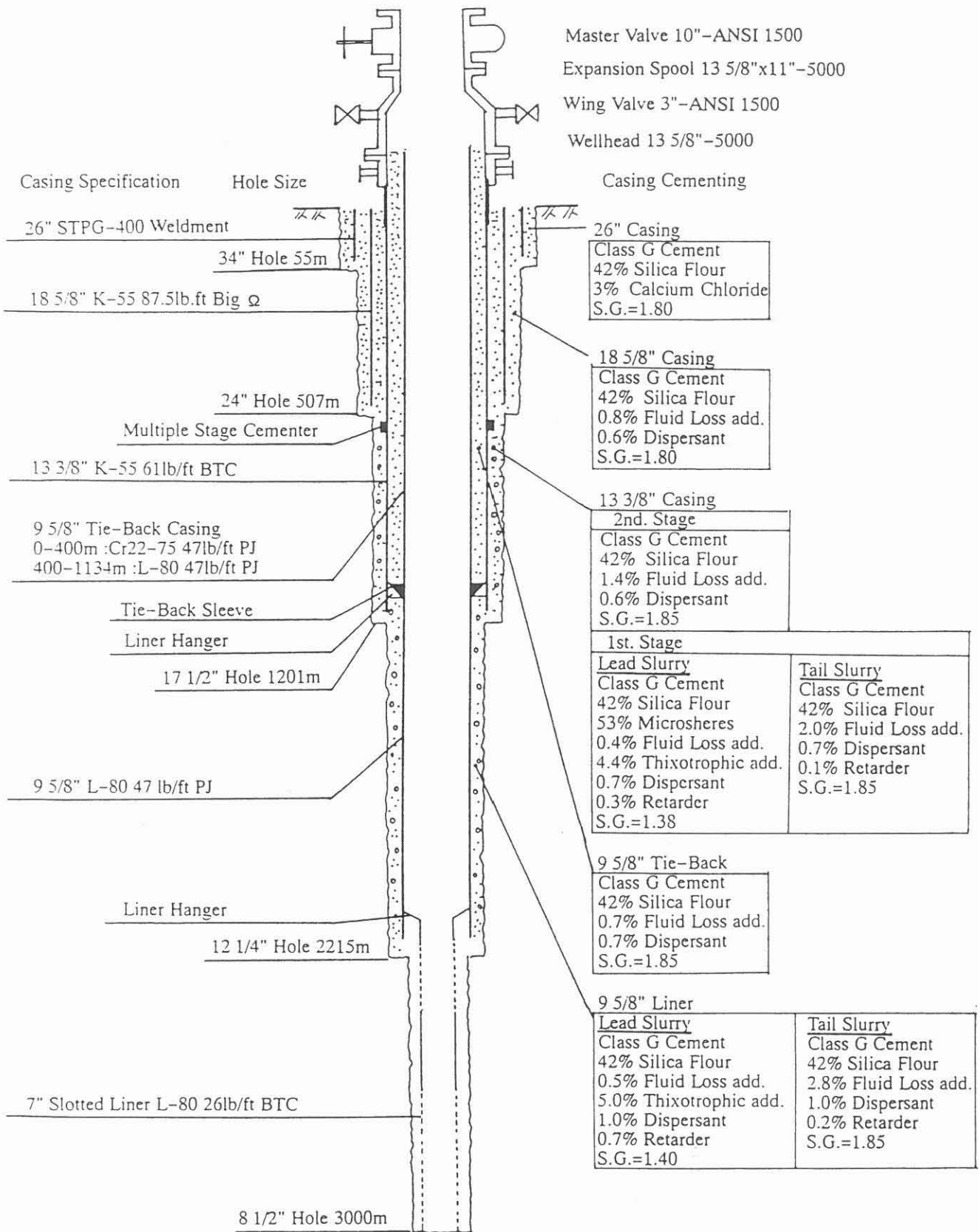

Fig. 7. Casing and cementing programs of K6-3

(Saito,1993b)

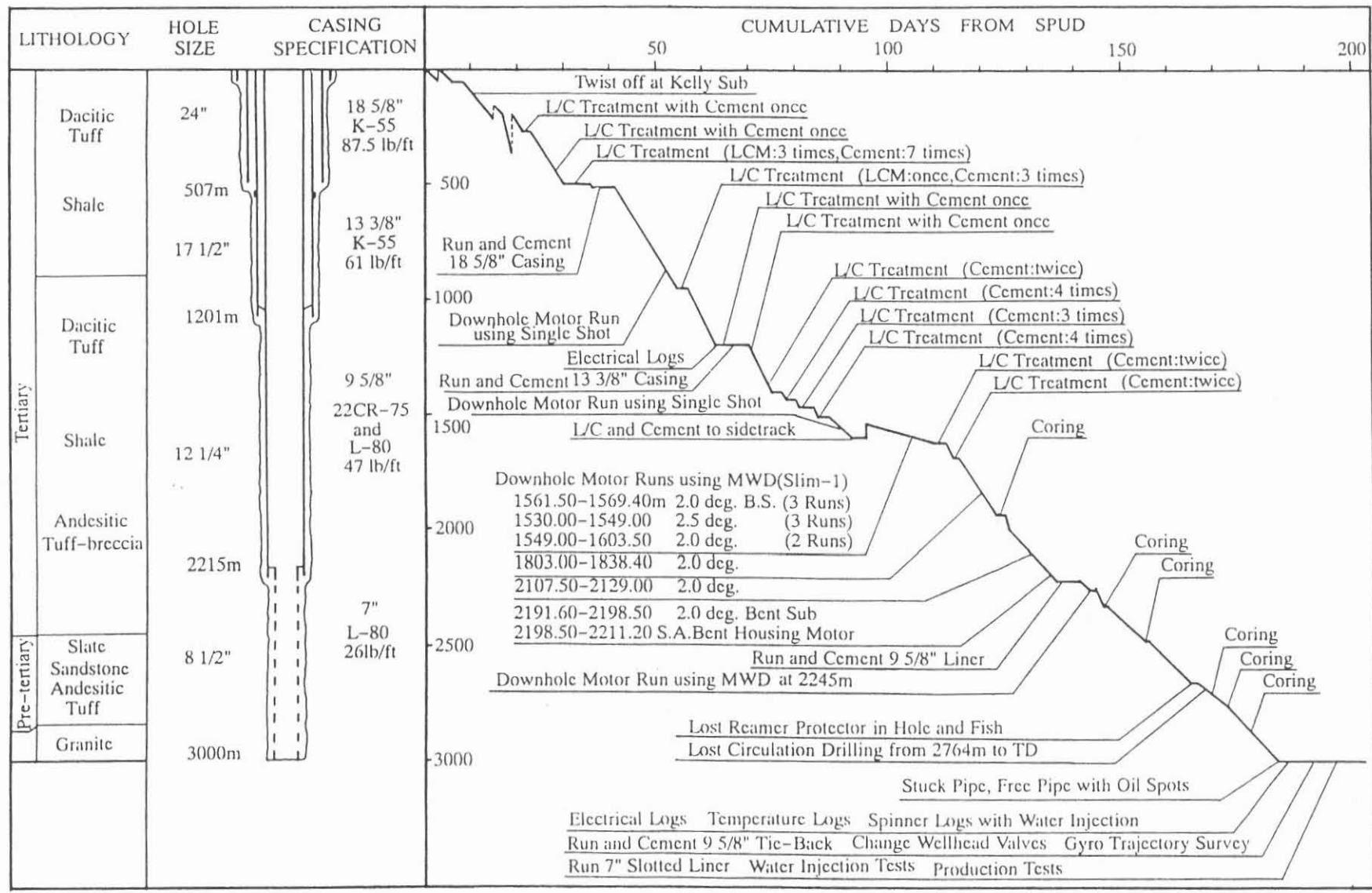

Fig. 8. Drilling history of K6-3 at Kakkonda

(Saito,1993b)

Table 2. MWD(SLIM-1) performance summary of K6-3 at Kakkonda

Hole size	MWD Run No.	Downhole motor run No.	Drilled interval(m)		SLIM-1					
			From	To	Hours run (h)	BHCT (°C)	Tool No.	Results	Down time (h)	Remarks
12 1/4"	1	3	1531.00	1548.50	2.7	65	063	good	0	
	2				27	62	093	good	0	
	3	4	1556.00	1569.40	26	64	093	good	0	
	4	5	1530.00	1539.90	18	64	093	no good	0.75	Battery wire parted
	5	6	1539.90	1542.70	13	65	063	good	0	
	6				2	65	072	no good	6	Dropping the tool resulted in: - Parted battery wire - Damaged Pulser Restrictor
	7				13	64	063	good	0	
	8	7	1538.00	1549.00	0	N/A	063	no good	1.5	Battery wire parted Battery pico Fuses blown
	9	8	1549.00	1565.50	10	65	072	no good	0	Intermittent tool jamming caused battery pico fuse to blow
	10				3.5	65	063	no good	1.5	As above
	11				7.5	65	093	good	0	
	12	9	1575.00	1603.50	24	65	063	good	0	
	13	Rotary	1603.50	1616.00	18.5	68	063	good	0	
	14	Rotary	1616.00	1624.00	14.5	77	093	good	0	
	15	Multi shot	1536.00	1611.00	1.5	77	093	good	0	
	16	Rotary	1685.50	1803.00	35	78	093	good	0	
	17				17	82	093	good	0	Change tool to put in new battery (45 minutes used)
	18				7	79	072	good	0	
	19	10	1810.40	1838.40	34	82	072	good	0	
	20	11	2107.50	2129.00	6	82	072	no good	3	Conductor wire insulation failed
21	0				N/A	097	no good	0	Tool free fell to bottom causing mainshaft to bend and pulser to flood	
22	20				82	072	good	0		
23	12	2191.60	2198.50	8	82	093	good	0		
24	13	2198.50	2211.20	10.3	82	072	good	0		
8 1/2"	25	14	2245.00	-	0.3	166	072	no good	1.5	High BHCT caused Tool failure
	26				1.5	150	093	no good	1.5	
	27	15	2245.00	-	0.3	166	072	no good	1.5	

(Saito,1993b)

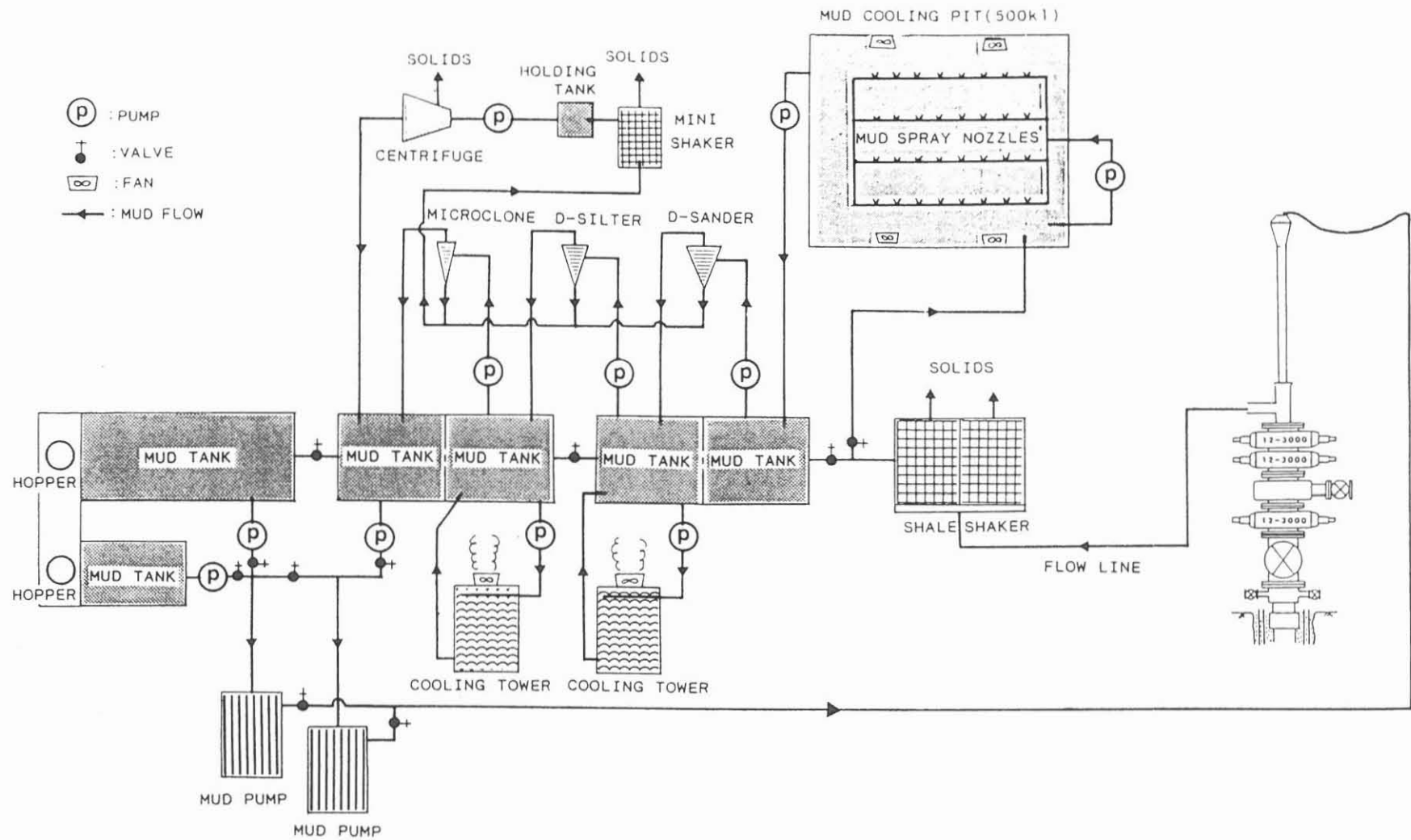

Fig. 10. Schematic of mud cooling and solid control system of K6-3
 (Saito,1993a)

Table 3. Downhole motor performance summary of K6-3 at Kakkonda

Hole size	Run No.	Downhole motor			Tool face measurement	Drilled interval (m)		Meters drilled (m)	Hours run (h.m)	ROP (m/h)	Mud temp.		Hours in hole (h.m)	Reasons to POOH	Downhole motor condition after POOH
		Maker code	Tool No.	Tool OD		From	To				In	Out			
17 1/2"	1	A	1	9 5/8"	single shot	860.20	880.40	20.20	13.40	1.48	45	58	25.00	Reached scheduled depth	Good Bearing wore out
12 1/4"	2	B	1	8"	MWD (SLIM-1)	1561.50	1588.20	26.70	8.10	3.27	49	68	23.00	Change BHAs	Bearing wore out
	3					1531.00	1548.50	17.50	25.30	0.68	47	63	41.30	WOC again to harden	
	4	A	2	7 3/4"		1556.00	1569.40	13.40	23.30	0.57	48	61	37.00	WOC again to harden	Bearing wore out
	5					1530.00	1539.90	9.90	24.20	0.41	42	62	36.00	Change bits	
	6					1539.90	1542.70	2.80	10.20	0.27	46	58	26.00	Lost circulation	
	7	A	3	7 3/4"		1538.00	1549.00	11.00	15.10	0.93	54	65	29.30	Change bits	Bearing wore out
	8					1549.00	1565.50	16.50	20.50	0.79	50	62	30.00	Reached scheduled depth	
	9					1575.00	1603.50	28.50	15.50	1.80	50	68	23.30	Reached scheduled depth	
	10	A	4	7 3/4"		1810.40	1838.40	35.40	22.00	1.61	54	74	36.00	Reached scheduled depth	Bearing wore out
	11	A	5	7 3/4"		2107.50	2129.00	17.20	21.50	0.80	56	83	39.30	Reached scheduled depth	Stator rubber came off
	12					2191.60	2198.50	6.90	5.20	1.29	60	82	21.10	Pump pressure went up	
	13	C	1	9 5/8"		2198.50	2211.20	12.70	5.30	2.30	64	82	22.40	Drag force increased	Good
	8 1/2"	14	A	6		6 1/4"	2245.00	Mud circulation					48	86	23.50
15		2245.00			Mud circulation								23.50	Pump pressure went up	

(Saito,1993b)

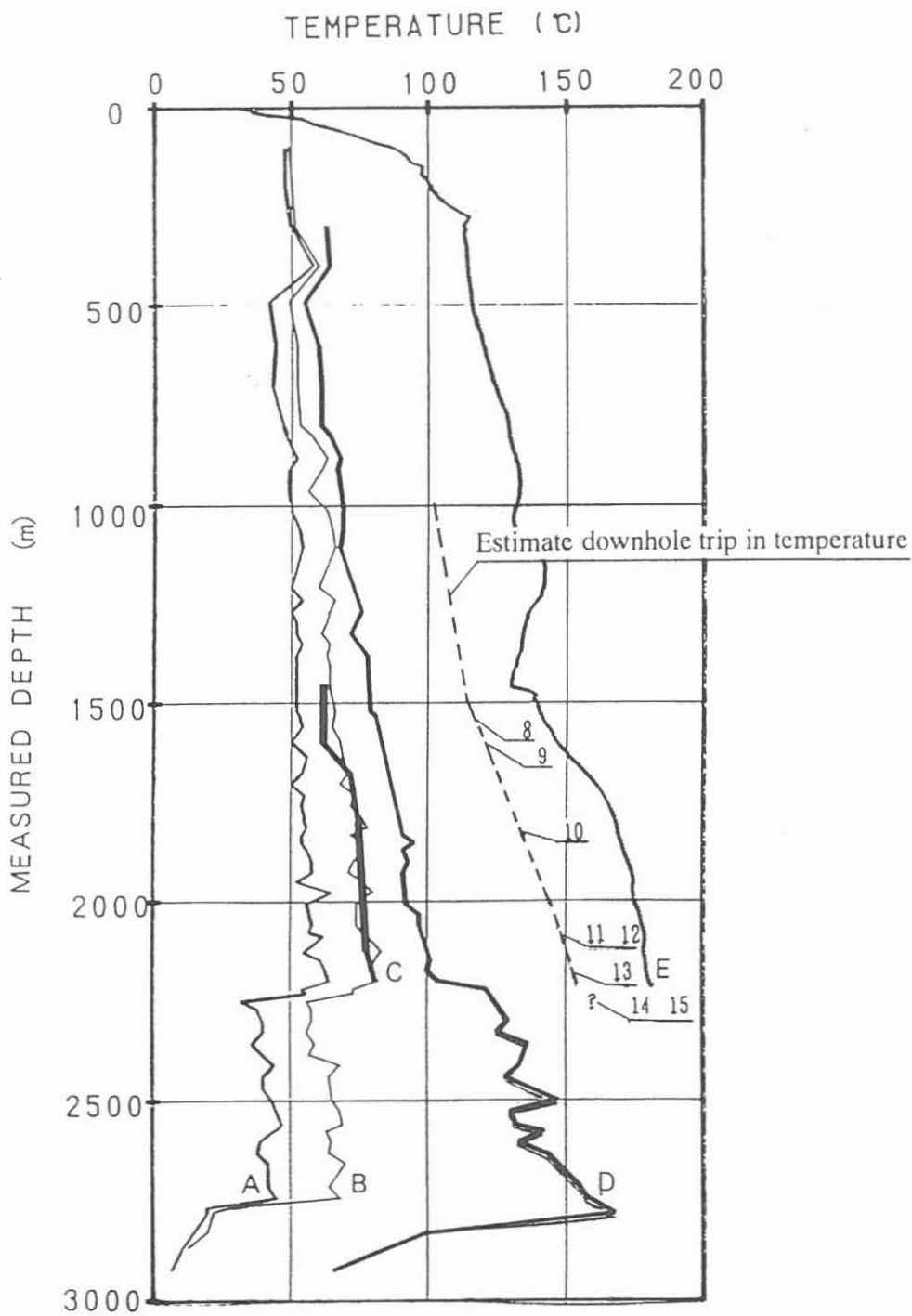

Fig. 11. Estimate downhole trip in temperature and downhole motor performance

8 through 15: Downhole Motor Run No.
Stator rubbers were Broken up after runs 12 and 15

Table 4. Drilling Fluid Plan of K6-3

Hole Size	34"	24"	17 1/2"	12 1/4"	8 1/2"
Well Depth (m)	0~ 55	55~ 505	505~1205	1205~2205	2205~2800
Additive	(%)	(%)	(%)	(%)	(%)
Bentonite	10	5	8	4	3.5
Dispersant	-	1.0	1.5	-	-
HT-Dispersant	-	-	-	0.3	0.35
Caustic Soda	-	0.05	0.1	0.3	0.5
Bicarbonate Soda	-	0.2	0.2	0.1	0.1
Deformer	-	0.04	0.04	0.04	0.06
Lubricant A	-	-	0.13	0.1	0.1
Lubricant B	-	0.01	0.01	0.02	0.03
Fluid loss Reducer	0.01	0.01	0.01	0.01	0.02
Diesel Oil	-	-	0.07	0.03	0.4

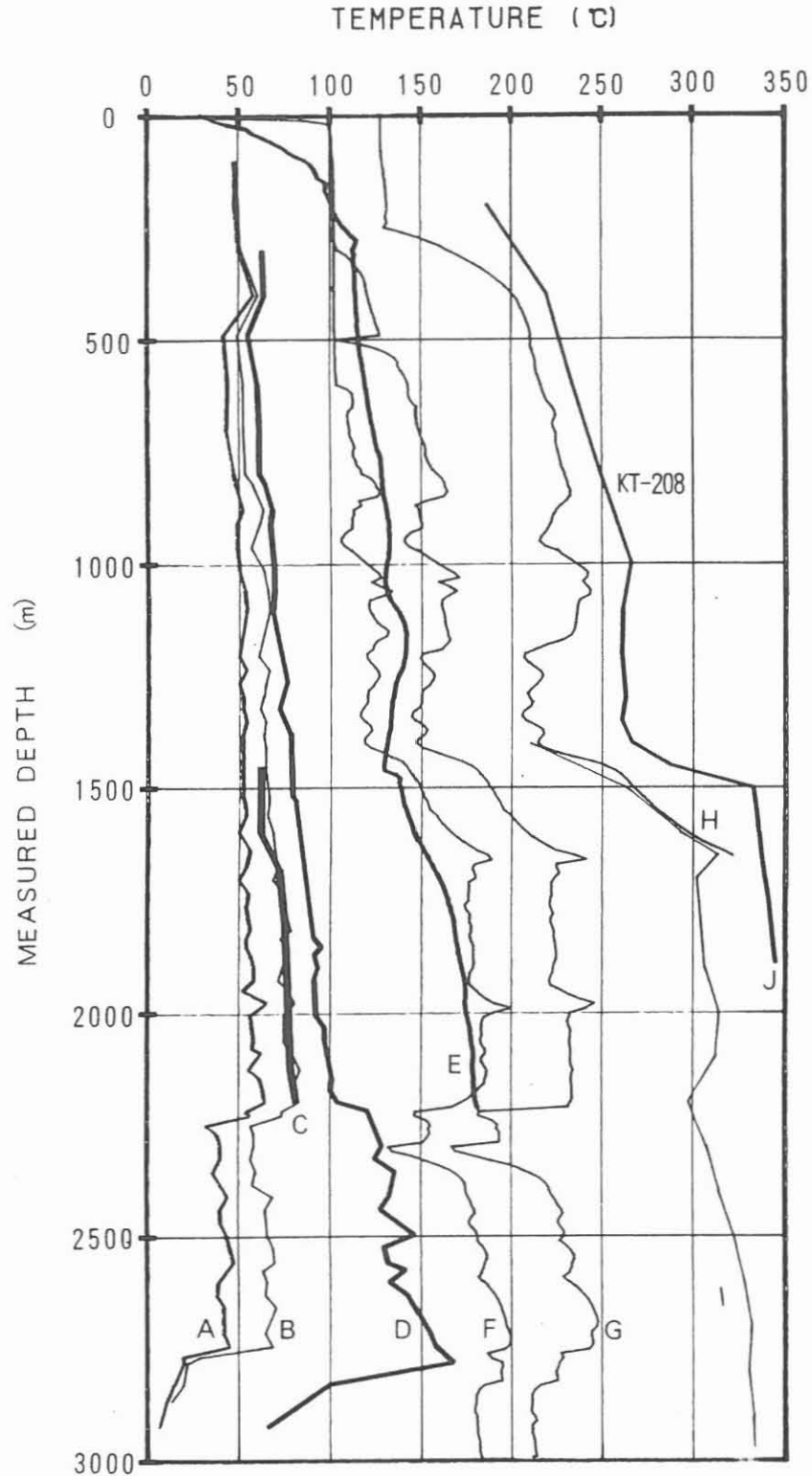

Fig. 12. Temperature distribution curves of K6-3 and KT-208 at Kakkonda (Saito,1993b)

K6-3

- A,B:Drilling Fluid Temperature measured at Suction Tank(A) & Flow Line(B)
 - C:Bottom Hole Circulation Temperature measured with MWD(SLIM-1)
 - D:The Temperature inside the NDC about 15m above the Bit within 1 hour after circulation ceased. Recorded with thermometers.
 - E:The Temperature Log Data at 13 3/8" Casing depth after standing time 12 hours.
 - F,G,H-I:Temperature Log Data at TD after standing time 24, 49 hours and 9 days.
- From 2,764m well was drilled with lost circulation

KT-208

- J:Temperature Log Data after standing time 4 months

E,F,G and H were recorded with Platinum resistance Thermometers.
I and J were recorded with Kuster Thermometers

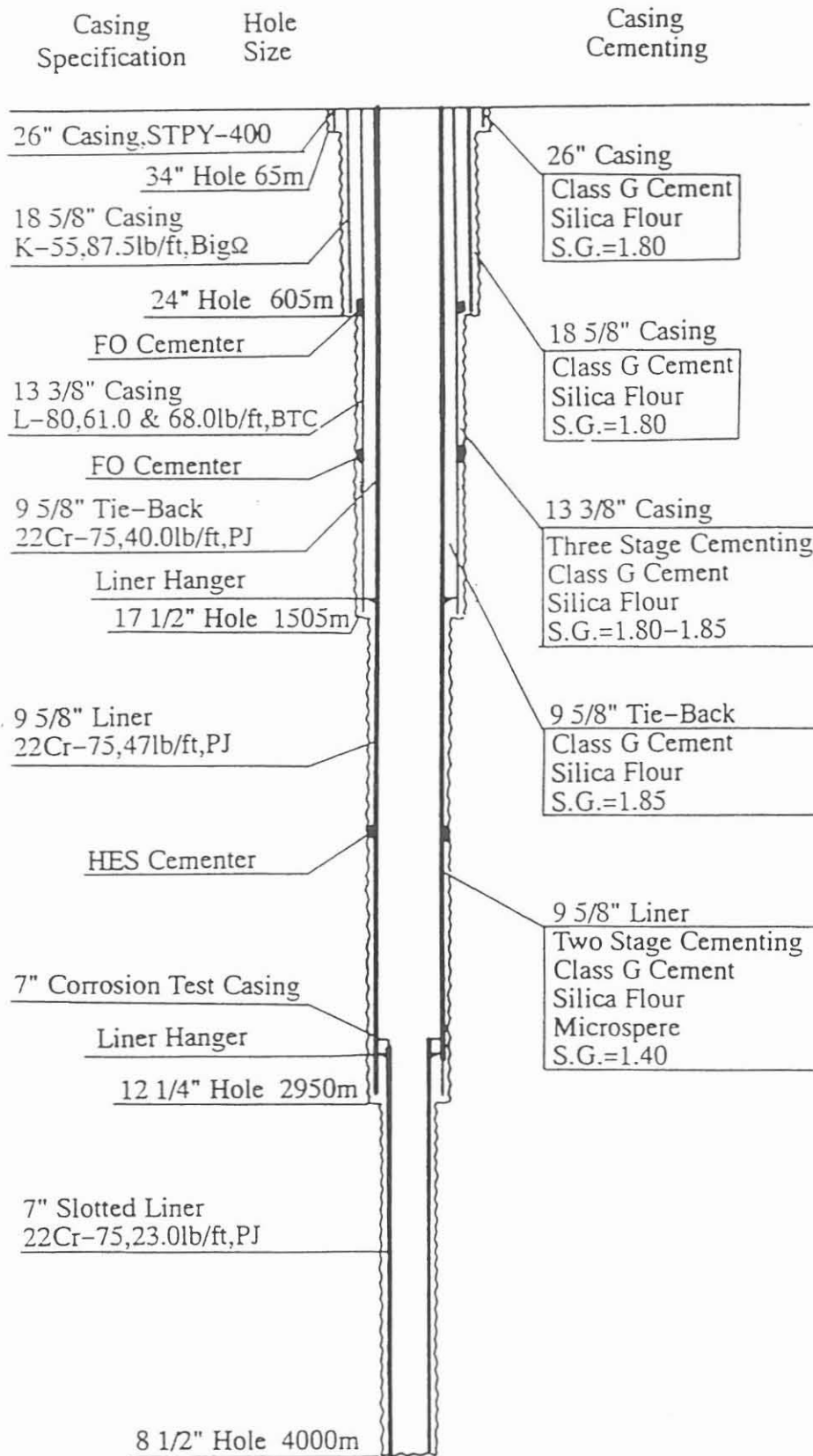
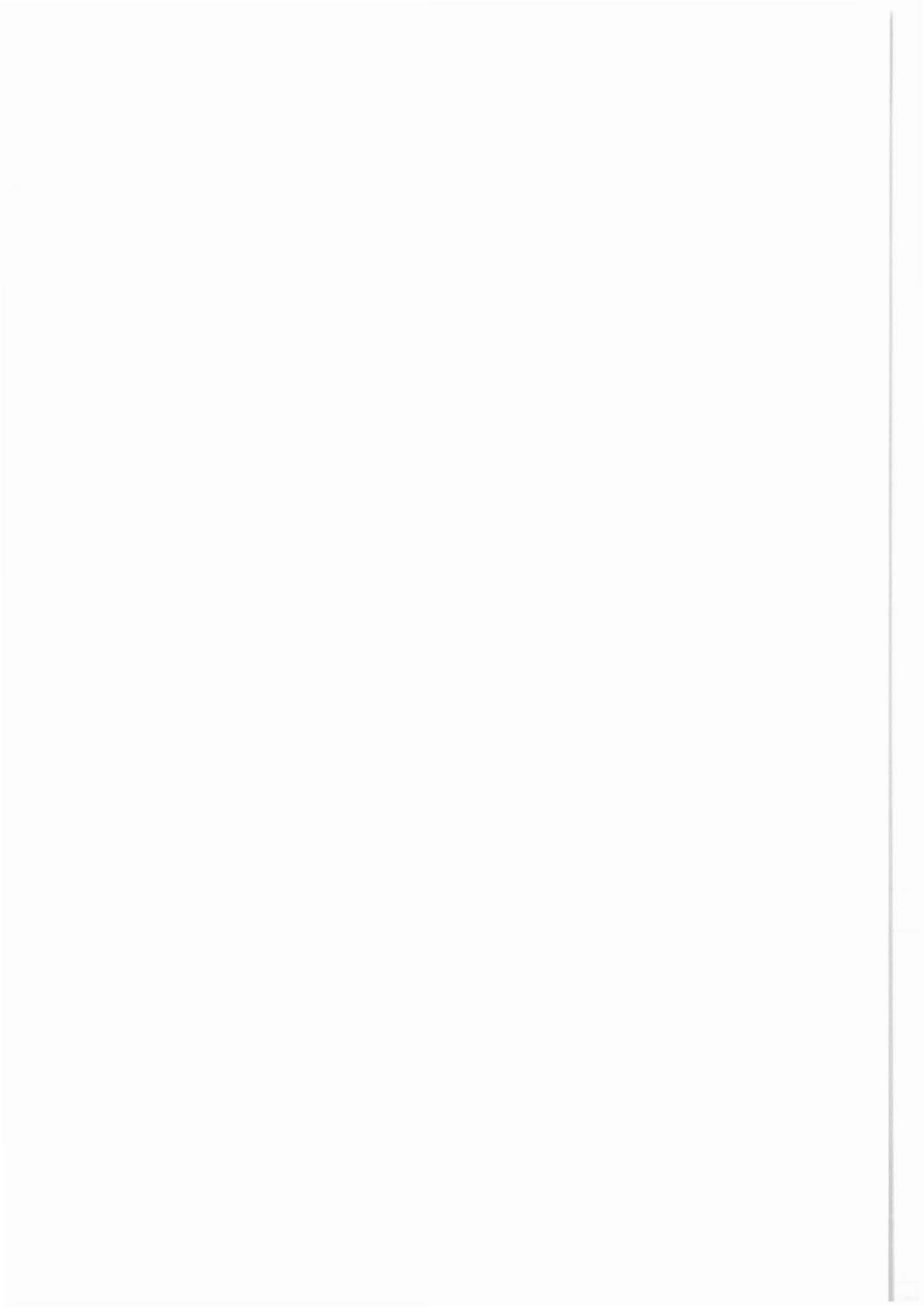

Fig. 13. Casing Program of 4,000m Hole
(Sasada et al., 1993)



**The strategy and concept of the proposed
pilot hole drilling in China**

Liu Guangzhi

Ministry of Geology and Mineral Resources
Xisi, Beijing 100812
People's Republic of China

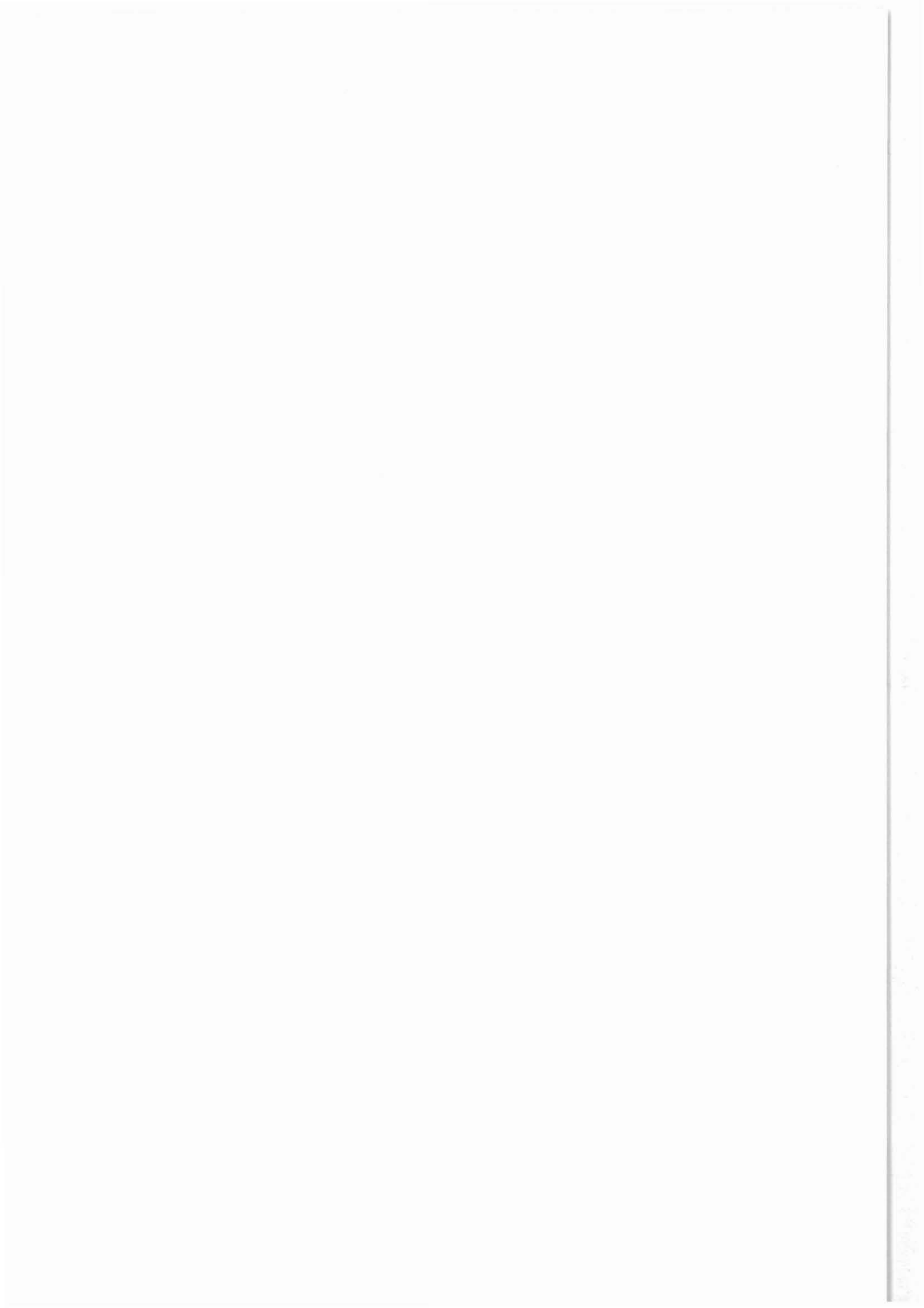

THE STRATEGY AND CONCEPT OF THE PROPOSED
PILOT HOLE DRILLING IN CHINA

Liu Guangzhi, Prof.

Member of CC-4 Group (International Lithosphere program)

Ministry of Geology and Mineral Resources,
Xisi, Beijing 100812, People's Republic of China

INTRODUCTION

The International Upper Mantle Project (IUMP), which was put forward by America in 1962, puts the deep geology, which takes the study of the structural form, ingredients and the history of evolution of the continental crust as the main content, to a new stage.

Parallelling this project are a series of scientific drilling projects, which have been risen for thirty years. For example, the Project Mohole which began at 1963, the Deep-sea Drilling Project (DSDP) which lasted for fifteen years from 1968 to 1983, the Ocean Drilling Project (ODP) which is being conducted from 1985 to 1995, the splendid Supper Deep Hole Drilling Project which was executed in former Soviet union in 1970, the arragement of 29 Scienstific Drill Hole Project in America (CSD) since 1984 and the German Deepdrilling Project (KTB) which began in 1987 in the F.R. Germany, etc.

The execution of all these scientific drilling projects have obtained surprising achievements in scientific research and gained valuable geological informations that couldn't be gained before. For example,

1. The execution of Deep-sea and Continental Crust Scientific Drilling Project has proved the theory of continental drift, sea Floor expanding and of plate tectonics and evolution of the crust to be true. And it has deepened our cognition, enhanced and inriched these theories.
2. Scientific drilling, which has reached the forbidden zone of geological prospection, not only opens up a new way for the deep mineral resources survey but also rewrites the available mineral-logenetic-theory. Having our eyes on the demand of people to the mineral resources and energy in 21st century, the improvement of protection to the living environment of mankind and the geologic disaster forecast has become a strategical task which brooks no delay.

Some Chinese geologists said that our country is facing a new period of turning our attention to the exploration of deep blind ore bodies. The demand of energy in 21st century has urged us to greatly improve our country's

study on deep geological research. The geological disaster and environmental protection and management, which have intimate relations with human being, also have urged us to gain a clear idea of the geological situation of deep zone. However, the current deep geology study cannot satisfy these demands. Therefore if we haven't started to prepare the continental scientific drilling project yet, we might face some major social problems like scant resources, disasters and deteriorated geological environment, and couldn't meet them, and then they would be likely to affect our country's economic development and social progress. We have suggested the leading departments concerned in China to treat the continental scientific drilling from the strategical points of dealing with our country's resources and development of science.

3. Scientific drilling is the only method of verify GGT transects, for improving the accuracy of its interpretation (1). Though we have done a lot of research on the earth's surface geology and geochemistry. But because of scant practical material, our cognition to deep section is limited, unilateral, and unsteady. Scientific drilling and borehole logging which coordinat with high temperature and high pressure test, would raise people's cognitions to a new level, which cannot be substituted by other methods.

Some scientists pointed out that the achievements of scientific drilling also indicate that almost all the geological bodies, that are deduced by geophysical materials, which exceed 1.5 km in depth, haven't been verified by drilling, that is to say, deep geophysical materials, if not examined and controlled by continental drilling, are undependable and unusable. So this challenges geophysics seriously, and further indicate that the execution of continental drilling is necessary and urgent. This discovery made continental drilling had not only scientific significance but also profound practical significance. Only by coordinating geophysical survey with drilling, can surficial geology be spreaded to the underground depth truly.

4. Scientific drilling, which reveals the construction of the earth's crust and alters the partial, surficial geology to the microscopic on that extends to continents and oceans, is an important component to the International Lithosphere Program and is a new progress of modern geoscience. That is, the study of geoscience has entered into a new stage that from employing outer space resource satellite to employing inner space scientific drilling. Japanese geologists describe it as "the next adventure after the lunar landing".

CATEGORIES OF DEPTH OF SCIENTIFIC DRILLING BOREHOLE

Over the past thirty years, the experience of large scale scientific drilling proved that it is necessary to solve some special geological problems in deep crust according

to concrete scientific purposes and select sites earnestly. Chinese geologists gained a common cognition that it is not a necessity that superdeep hole must be drilled at the beginning. Of course, deep hole and super deep hole should be executed in special area and its depth can be increased or decreased according to the problems which met in execution.

Pilot Hole	2,000 - 4,000 m
Deep Hole	4,000 - 6,000 m
Super Deep Hole	6,000 - 15,000 m

GAINING NEW PROGRESS ON CSDC

In recent two years, Continental Scientific Drilling in China (CSDC) has gained new progress.

1. "The First Seminar on Continental Scientific Drilling in China" was held from April 15 to 17, 1992 at Chinese Academy of Geoscience, Beijing, organized by the Research Group of the Pilot-Phase Research of CSDC.

Sixty experts and professors from geology, geophysics, drilling, borehole logging and measuring and testing circles discussed on site selection. From April 18 to 19, theses on drilling were presented and achievements were reported.

Common Cognitions in Six Main Respects on the Seminar:

- A. Getting a deeper cognition that through scientific drilling, geological theory can be improved, geological research deepened. And it is of great significance to the prospecting on mineral resources, forecast of geological disasters, and protection of environment, etc.
- B. China has a vast territory, and with rare geological structures and characteristics in the world. So scientific drilling, which will be executed there, will produce great influence and contributions to the progress of geoscience around the whole world.
- C. Scientific drilling, which plays an unsubstitutive role on developing geoscience, is a systematic engineering of high difficulty, high investment, high technology and high efficiency. Meanwhile it is the motive force to improve geological technique and method.
- D. It doesn't mean that the deeper the borehole the better it will be. This fact has been assured on the concept of scientific drilling. The key lies on solving scientific problems. So we should conduct it by linking with our country's specific conditions and take the strategy of combining remoteness with nearness, deepness with shallowness, and with three stages, that is, in the initial stage (1990-1995), we can drill some pilot holes; in the middle stage (2000-2010), we will drill a few deep holes and after 2010 we strive for some super deep holes.

- E. Continental scientific drilling is a significant program in which combined geoscience and geophysics with engineering techniques. Therefore, it should be cooperated energetically, and prepared as soon as possible depending on both our own force and international cooperation by attracting foreign capital and modern techniques.
- F. In this seminar, some thirty selected strategic zones of China scientific drilling were put forward initially, respectively focused on geological basic science, replacement of resources, geological disasters or purpose of multiple sciences.

The experts attended the seminar put forward some thirty strategic zones, which can be roughly divided into three categories: those are for the purpose of science; and specific prospecting in combination with purpose of science; and for the purpose of solving the problem of geologic structure, which attracts the attention of the whole world, with special structure region, like Qingzang plateau, North China and three rivers area as the stress and getting foreign investment, talents and equipments.

- 2. "The Second Seminar on Continental Scientific Drilling in China" was held in Beijing from May 11 to 12, in 1993. Through the discussion among the experts, seven main zones were selected out according to the principle of "shallow boreholes first and then deep boreholes" initiated at the first seminar.

They are: (1) Beijing, Tianjing, Tangshan area -- for the purpose of monitoring earthquake, basic geology.

(2) Three Gorges area - for the purpose of disaster geology, basic geology and ecological environment.

(3) South Shandong area - for the purpose of basic geology and mineral resources.

(4) West ring of Nanxin Basin - for the purpose of basic geology and mineral resources.

(5) Jin chuan, Gansu Province - for the purpose of basic geology, mineral resources and earthquake.

(6) Panxi, Sichuan Province - for the purpose of basic geology, mineral resources and earthquake.

(7) Longmenshan area, Sichuan Province - for the purpose of basic geology and energy:

It was indicated in this seminar that the geological and geophysical work in these area should be further well conducted. For instance, (1) The detailed geological survey in these selected area, completing the surveying map by the proportion of 1:10,000.

(2) Critical geological problems in these area should be studied.

(3) Survey and analysis of geophysical (including gravity, magnetic, electric, geothermic and seismic method, etc.) and geochemical abnormal phenomena.

3. Establishing "National Laboratory on Super-deep-hole Drilling"

The "National Laboratory on Super-deep-hole Drilling", established in the China University of Geosciences (Beijing) under the subsidization of World Bank, State Education Commission, Ministry of Geology and Mineral resources, has had an initial scale. It will gradually undertake the study on the modern technologies of scientific drilling, establish relationship with concerned labs in the world, and set up a scientific drilling data bank which networked with those in foreign countries, educate post graduates (Master, Doctor, etc.), prepare a high temperature and high pressure simulation test stand, strengthen the contact with foreign countries in information exchange.

4. Ask for Establishing Project to National Science and Technology Commission

The construction of a scientific drilling project is a complex system of engineering invalue many scientific research institutes, a large amount of research articles have to be developed and consuming tremendous funds. So the MGMRC has form an official report "Continental Scientific Drilling in China and Dynamics and Evolution of the Lithosphere Program" in July 1993.

5. In 1990, the research group of the Pilot-Phase Research of China Continental Scientific Drilling began to undertake the organization and accelaration work of drill sites selection and achieved remarkable success. This work was suspended in 1993 and the remaining work should be reconducted later on.

6. "A Series of Exploration of the Deep Continental Crust", 1-8 volumes, which sum up to 2,800,000 Chinese characters, have been published. These books have collected the thesises of all past International Scientific Drilling Conferences, and the information of former Suviet Union, CSD, KTB and JSD, which have become the valuable material for Chinese colleagues.

7. Strengthening International Exchange

An agreement has been signed with the Technical University of Clausthal Germany on the education of postgraduate students for Masters and Docterate degrees as well as acadymic exchanges between professors from both countries.

A scientific drilling investigation group was sent to Japan in Dec. 1991 to study the methods and experiences on selecting drill sites. In July 1992 a Russian

delegation, with Professor B.N. Khakhaev as the chief, visited China and introduced the achievements and experiences of super-deep-hole drilling in Russia. In June 1993, China scientific drilling delegation visited Kola Peninsula and Ural super deep hole drill sites and super deep hole drilling institute and facilities. Chinese delegation also attended international conferences, which were held by CC-4 Group in Regensburg Germany and Paris, France.

THE DESIGN OF PILOT HOLE OF CONTINENTAL SCIENTIFIC DRILLING IN CHINA

The achievement of geological research, the target of geoscience, deep geophysics, the result of geochemical prospecting and experiences in hand are the bases for determining the drilling strategy, conducting design of technology for selecting research and development projects for continental scientific drilling in China.

Of course, there is a restricted factor in China, that is the investment, so it is proper to make the policy of "from shallowness to deepness", from easy to difficulty", and of executing pilot hole (2,000-4,000 m) before deep hole and super deep hole drilling.

MAIN TASK AND ROLE OF PILOT HOLE

(1) To get the riched geoscience information of lest costs and risks, without employing giant drill.

(2) Cores, Cuttings, fluid and gas samples should be collected continuously in whole borehole except overburden, and various in-hole geophysical and geochemical comprehensive logging should be conducted to collect completely and precisely the geophysical and geochemical data.

(3) Decreasing the work of recovering core and logging the well in the long section of the main hole, meanwhile pilot hole is rather small in size, the costs on coring and logging are more cheaper.

(4) Geothermal section should be measured in the pilot hole. Several core holes, around 300 m deep, near the main hole, should be drilled to measure the rate of geothermal conduction and heat flow density in order to deduce the geothermal section of the main hole, the temperature at hole bottom, and establish mathematical model. The measured data in the pilot hole will be employed to verify the geothermal model at greater kepth on the main hole. The variation of geotemperature is the most important factor for seleting scientific coring tools, logging instruments, the constructional ability of liquid and gas sampling tools.

(5) A variety of newly-designed drill bits, drilling tools and measuring instruments can be tested in the pilot hole.

(6) To test the gradient of stratigraphic pressure, provide the lost circulation zone and flush-in zone with locating, qualitative, quantitative data, also provide formation deflection trends and the stability of the borehole wall with reference data.

(7) Training our drilling group and various members for the preparation of the execution of super deep hole.

The pilot hole will penetrate hard to very hard crystalline bed rock from surface to 2000-3000 m, and hopeful to 4000 m, with a final diameter of no less than 85 mm, for the convenience of borehole logging. Diamond bits for mine core drilling with relatively thin walls (compared with oil well drill bits) will be adopted to decrease the volume of rock fragmented, increase penetration rate and core recovery, improve core quality and save costs. There are important reasons why we decided to use slim hole diamond drilling method for pilot hole drilling program.

Slim hole (or called small bore or mini-bore) drilling is an advance drilling technology used for exploration of oil and gas or solid minerals, especially in Canada and South Africa in the past twenty years.

In the past fifteen years, more than thirty deep cored hole (av. depth 2000 m), maximum deep hole 2505 m have been successfully drilled in Shandong, Jiangsu area, more than fifty of deep oil and gas wells (av depth 6000 m) have been drilled by MGMR. Now those holes may be used for "holes of opportunities".

SLIM HOLE DIAMOND DRILLING RIGS

Three type of deep diamond core drilling rigs can be selected. They are XY-6, TXL-1E and HS-150.

XY-6 core drill was developed by Chinese, the drilling capacity can be seen in

Table 1 Drilling capacity of XY-6 core drill

Drilling capacity	drill rod	open hole diameter	bottom hole diameter
(m)		(mm)	(mm)
2000	HQ,NQ,BQ	150	60(59.52)
1500	HQ,NQ	168	91-94

TXL-1E drill was imported from Tone Co. Japan, by using it, more than thirty boreholes, which were 2000-2500 m in depth, have been drilled. Rich experiences on executing deep core hole have been accumulated.

Table 2 Drilling capacity of TXL-1E core drill

Drill rod	drilling capacity (m)				
	single line	double line	triple line	four line	five line
BQ,BQT,BW	800	1500	2150	2700	3200
NQ,NQT,NW	600	1150	1600	2000	2400
HQ,HQT,T50A	450	850	1200	1500	1800
101WL 01WL	350	650	950	1200	1400

Note: Hoist capacity: single line: 5T
 double line: 9.5T

HS-150 core drilling rig was manufactured by former Heath-sherwood Co. Canada. Now it is possessed by Heath-sherwood drilling (1986) Inc. By using this type of drill, a great amount of solid minerals, oil and gas drilling tasks in Canada, America, South America and South Africa were contracted. All the depths of the boreholes drilled are around 2000 m - 5000 m deep. It did a remarkable job in Sudbury, the well-known nickel mine in Canada.

I have never seen such a modern deep core drilling rig before.

The drilling rig has proven to be very reliable after drilling several hundred holes with the diamond core bit to depths of over 3000 m, including the deepest borehole 5424 m (17,791ft) drilled by a wireline diamond core drill made in South Africa in 1987. This drilling rig is light in weight with a small power unit (225 hp) and occupies a maximum drill site of 150 m². The whole unit can be easily disassembled into six pieces. Diamond geological drilling technology can be employed with the available skilled drillers and the rig is easily operated. The diameter of the hole can be reamed, so as to meet the need of a variety of logging and sampling jobs. The diameter of the borehole is small; thus, rock fragmentation volume is lower and operation time greatly reduced.

The main technical features of the HS-150 are: maximum drilling capacity of 4573 m (15,000) with an N (70 mm) drill rod; a total weight of 60 tons (including derrick); and a two-step jack knife and cantilever derrick erected entirely by rig power with the total height of 27.4 m. The length of the drill rod stand is 18 m with a 100 ton hook load. A G.M. diesel 6-71 with 225 H.P. runs all the equipment. Two

separate high pressure hydraulic pumps run the draw works (107 m x 25.4 m cable, wireline winch (4600 m x 6 mm, 1 x 19 air craft cable), pump (oilwell triplex) and hydraulic head. The hydraulic head has infinite speed control, 3 : 1 and 1,8 : 1 reduction, max. R.P.M. with 3 : 1-600 rpm and max. torque-262 kgm. max. R.P.M. with 1,8 : 1-1800 rpm and max. torque-166 kgm. 1220 mm feed stroke, 762 mm retraction of head.

Slim Pilot Hole Diamond Drilling Program

The Slim pilot hole diamond drilling programm can be seen in Figure 1 with a max. depth of 4000 m.

Table 3 Drilling and Casing Program

csg program	hole depth (m)	bit type	hole size	csg depth (m)	csg size
conductor	2	tricone	311	2	219.1
surface	150	tricone	190.5	150	163.3
intermediate	1500	HNQ	101.6-108	1500	127.0
ream to	1500	RTT	150	1500	
technical	2500	HNQ	101.6-108	2500	94.0
open hole	300-400	NBQ	82.5		

Note: RTT-Retractable bit vs reamer

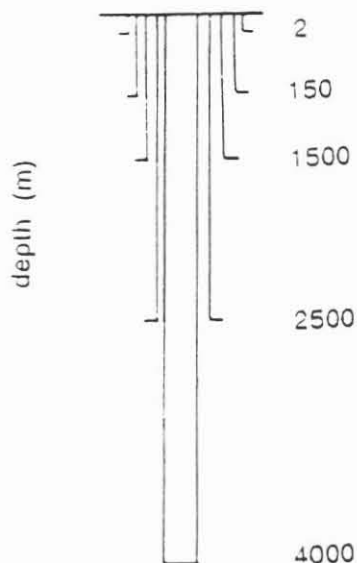

Fig. 1. Slim pilot hole diamond drilling program

Super Series Drill Rod

To meet the requirements of deep hole drilling, the first consideration is to have a drill string capable of drilling to this depth. This means that it should have enough strength, wear resistance, and remote maneuverability for rugged bush areas, while being light enough to be used with the portable diamond drilling rig. For these reasons, Heath & Sherwood Drilling Inc. of Canada designed and developed the super series drill rods in two sizes, super-H and super-N. The rod body is made of an aluminum alloy with high-strength, alloy steel couplings and joints torqued into the aluminum rod body and held together with an epoxy bond. The rods are flush on retrieval of the wireline inner core barrel. Inside diameters were reduced from normal standard wireline rod sizes for increased rod strength.

Steel drill rods with equivalent outside diameters are also developed for drill collars at the bottom of the drill string. The sections of steel drill rods used might be one-fourth of the whole string to form the required bit weight. O-rings were put into rod joints to prevent liquid leakage.

Table 4 Super series drill rod specifications

size	super H		super N	
	steel rod 4140	Al-rod steel epl 4140	steel rod 4140	Al-rod steel eplg 4140
O.D. mm	88.9	88.9	70	70
I.D. mm	61.9	66.7	50.8	50.8
thickness	13.49	11.11	9.53	9.53
Min. yeild strength (kg/mm ²)		53.4	70	53.4
burst str. (kg/mm ²)		14.8	17.6	14.1
collapse str. (kg/mm ²)		8.7	9.1	8.8
torque of joint (kgm)			138.5	935
req'd makeup			375 max	375 max
torque (kgm)			250 min	250 min
length/section (m)	3.65	3.65	3.65	3.65
weight (m/kg)	25.07	8.68	14.14	3.65

Larger Inner Annulus Wireline Coring System

Heath & Sherwood Drilling Inc. have also developed larger inner annulus wireline coring system two sizes namely HNQ and NBQ for deep hole coring. As drilling fluids pass through the inner annulus at decreased pressures, the inner tube drops into the coring position more quickly than the normal. In an H size hole, an N size core is recovered, and when an NBQ is used in an N size hole, a smaller size B core is recovered. These cores are sufficient for surface inspections and chemical analysis.

Oversize Diamond Bit

Other factors to be considered when drilling to these depths is having an unimpeded and smooth flow of drilling fluid. This means there will be an outer clearance between the hole wall and the drill string, necessitating the uses of the oversized diamond bits with a larger kerf area. Performance indicates that this slight increase in bit kerf presents no problems for penetration rates of bit service life.

Table 5 Specs of larger annulus wireline coring system

Size	HNQ	NBQ
O.D. of outer barrel (mm)	88.9	70
Outerbbl 1. DxInner bbl O.D	77.8x55.6	60.3x42.9
I.D. of inner barrel (mm)	50.8	46
core diameter (mm)	47.6	36.5
annulus between inner vs. outer barrels (mm)	22.2	17.46
wt/3m (kg)	88.45	55.34
wt/6m (kg)	148.33	93.44

Table 6 Comparison of normal & oversized diamond bits (mm)

normal size of bit O.D.	96(HQ)	75.5(NQ)
normal size of drill hole	96.5(HQ)	76(HQ)
oversized bit O.D.	101(HNQ)	81(NBQ)
oversized drill hole diameter (max)	101.6-108(HNQ)	76-82.5(NBQ)
max, clearance bet. hole & rod	9.55	6.25

The External Upset Internal Flush Tool Joint Wireline Coring System, Tone Co.

Another choice is the External Upset Internal Flush Tool Joint Wireline Coring System, which was manufactured by one Tone Co. This system has been used in China for a lot of years, the result is very good.

Table 7 The properties of wireline coring system, Tone Co.

Name	Steel code (JIS)	Tension strength (kg/mm ²)	Yield strength (kg/mm ²)	Bending (mm/m)	HB
Drill rod	ST0-D	>67	>39	<1	
Drill rod joint	SCM-3CrMo	>95	>80		
Drill collar	SCM-3	>85	>70	<1.5	255.310
drive rod joint	STKM-16C	>63	>47	<1	
drive rod joint	HS-6, MnCrMo	>60	>40		
Wireline drill rod				Torque	
HQT	TS-R90MnMoV	>85	>63	451 <1	
NQT	TS-R90MnMoV	>85	>63	328 <1	

Torque (kgm) max. 1366, safety limit 904

Table 8 Specifications of the tubings for wireline coring systems, Tone C.

Name	OD/ID (mm)	End structure (mm)	Tool joint (OD/ID)	Single length (m)
Drill rod	60.3/46.1	External upset 67.5	85.7/44.5	9.0
Drill collar	88.9/38.1	Straight wall	88.9/38.2	4.57 35 kg/m
Wireline Drill rod		Flush joint Tapered thread		
HQT	88.9/77.8			4.5
NQT	70.0/61.9	Inner upset ID 60.3		4.5
Wireline drill double tube				
HQT	92.1x77.8 73.0x65.8	(OD X ID)	Outer barrel/ inner barrel	5.0
NQT	73.0x60.3 55.6x50.0	(OD X ID)	Outer barrel/ inner barrel	5.0

Table 9
Relationship of the clearance of the tubings for wireline coring systems, Tone Co.

	HQT	NQT
O.D. of Outer barrel	92.1	73.0
I.D. of Inner barrel	65.8	50.0
I.D. of Oversize bit	63.5	80.0
Core diameter	63.5	47.6
Reaming shell dia.	101.5,101.7	80.5
Hole diameter	101.5-101.7	80.5
Outer annulus (1)	4.7-4.8	3.75 (hole wall vs core barrel)
O.D. of WL Rod	88.9	70.0
Outer Annulus (2)	6.3.6.4	5.25 (hole wall vs drill rod)

Note: (1) the clearance between the hole wall and the outer barrel of the double-tube, single side
(2) the clearance between the hole wall and the wireline drill rod

DEVELOPING WORK AROUND CSDS

Though there are some difficulties on researching funds, research and development have began, and focus on three aspects.

I. Develop High Performance, Long service life, Aggressive Diamond Bits and reamers

Sharp bit is the principal part for drilling through the crystalline rocks, to which, great importance must be attached. Sharp and long service life diamond bit can increase the quantity of the core recovered and improve its quality, extend the length of lifting and lowering the bits. This is very important for deep hole drilling.

1. To use premium quality (AA,AAA) natural diamond for surface set diamond bits. Multi-step type is chosen in constructing kerf. Vring or single-step v-ring are chosen for impregnated bit. High strength synthetic diamond must have high property of thermal stability when it is employed to make impregnated bit.

The structure of diamond coring bit must be carefully designed. Side edges should be heightened to 15-20 mm to maintain the dynamic balance of drill rod under high speed rotation. Inner and outer edges must be strengthened by using monocrystal diamond of superior quality.

Chromium can be plated or hard alloy powder be welded partly in order to protect the connection part between side matrix and steel blank from being eroded.

As for the manufacturing methods, we trend to use the method of infiltration process of cold pressing and infiltration process of vibration to manufacture natural diamond surface set bit. Synthetic diamond impregnated bit are usually made by hot-pressing or electroplating method.

2. Development of Super-hard Materials and Related Core Bits

a. Katanite and its wireline core bits

Katanite, a kind of modern super-hard insert, made by using special high-temperature and high-pressure sintering process, is specialized in drilling to very hard rock with new-cutting mechanism. The slots are made up by modern using hot-pressing approach or infiltration process of vibration, and then are fastened with the inserts by using middle-temperature brazing method. Insert has a negative angle of 10 to 20 degrees, and a radial angle of 0 to 10 degrees, and gauge is maintained with PCD.

b. Carbon (Synthetic Carbonado), a kind of new type of super-hard material, is being developed under the aid of Russian. The inserts, to be made into a special shape, are directly set on wire-line coring bits.

c. Reamer of special shape

Several types of proper-sized reamer bits are

manufactured, like eccentric drill bit, which is used to enlarge the hole diameter under the casing shoe, small-tapered reaming shell and tapered reaming shell.

II. Developing Down Hole Motor Driven Double-tube Coring and Wireline Coring Systems

The down hole motor mentioned here is divided into two types: Down Hole Hydro-hammer and Bottom hole PDM. Down hole hydro-hammer is controlled by drilling fluid, which is pumped from drill rod to the hole bottom, to make drill pipe rotate to drill a borehole. Hydro-hammer can be divided into two types according to their structure: nonspring double-acting hydro-hammer and positive acting hydro-hammer. In addition, there is another type i.e., fluidic type. We have combined these three types of hydro-hammers with wireline coring system into Hydro-hammer driving wireline coring system and popularized them in applications for several years, and it has been well-done. Through proper strengthening, we think it has the potential in deep hole and super-deep hole drilling.

As for the bottom hole PDM driving wireline coring system, its structure and desired function and result are all encouraging. But its vulnerable points, i.e., the materials of stator, bearing, improvement of torque, improvement of heat-resistance quality. If all these technical problems are solved, the service life of entire motor can be raised more than two hundred hours.

Table 10 Down Hole Motor Driven Wireline Coring System

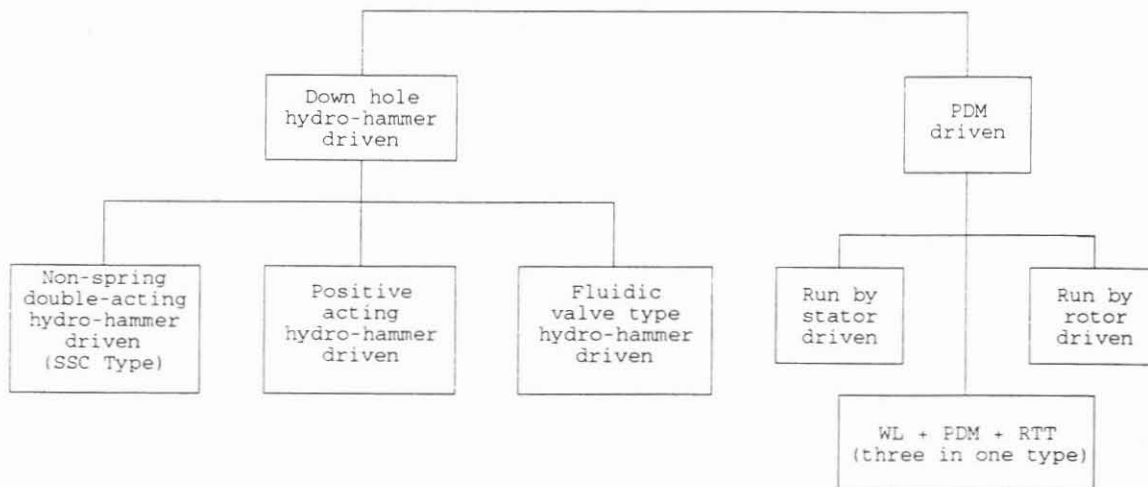

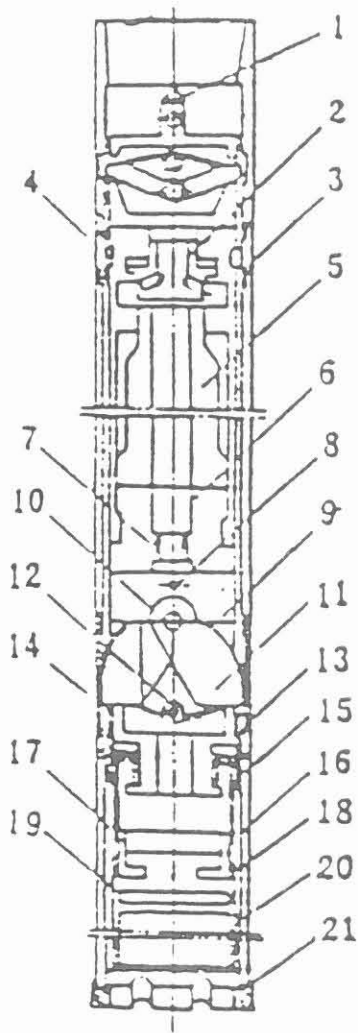

Fig.2 Sketch map of SSC series of Hydro-hammer Wireline Coring System

1. Spear head; 2. Valve; 3. Sealing case; 4. Sealing adapter; 5. Punch hammer; 6. Anvil; 7. Choke ring; 8. 10. Cylinder pin; 9. Work transferring plate case; 11. Work transferring plate; 12. Spring; 13. Spline case; 14. Strike bearing ring; 15. Spline axle; 16. Outer tube; 17. Upper separation joint; 18. Retaining ring; 19. Lower separation joint; 20. Inner tube; 21. Bit

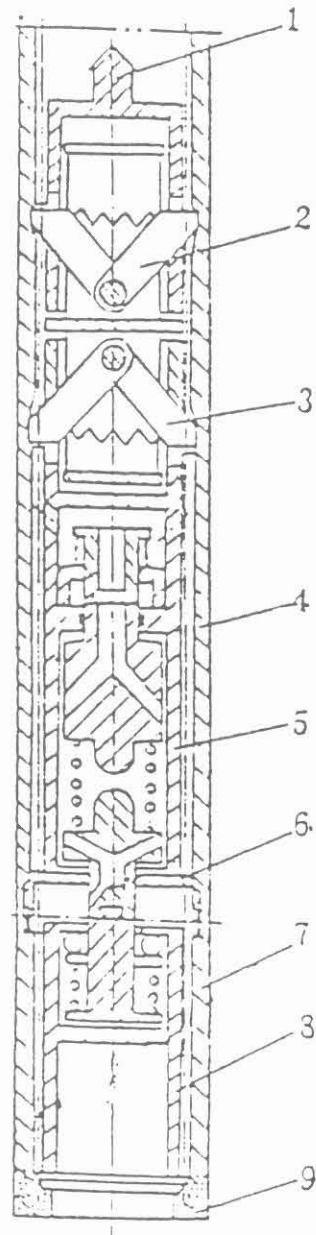

Fig.3 Sketch map of TKS Hydro-hammer Wireline Coring System

1. Upper tapered shaft for spear head; 2,3. Upper chuck; 4,7. Outer tube; 5. TK positive acting Hydro-hammer; 6. Impact energy transferring ring; 8. Inner tube; 9. Diamond bit

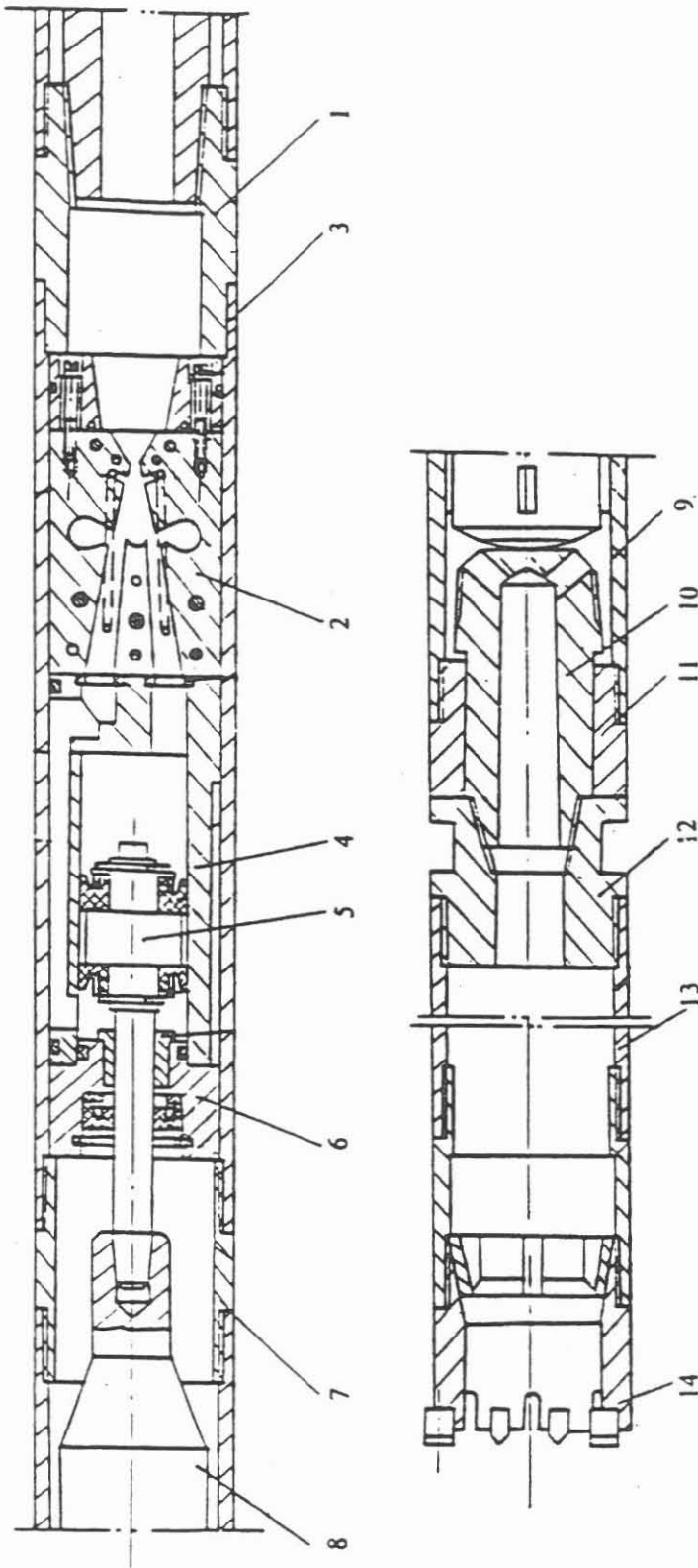

Fig.4 Structure of SC fluidic type hydro-hammer wireline coring system

1. sub; 2. bistable fluidic element; 3. outer tube; 4. cylinder body; 5. piston; 6. lower cover; 7. core barrel coupling; 8. heavy hammer; 9. outer tube of heavy hammer; 10. anvil; 11. spline adapter; 12. adapter; 13. core barrel; 14. it

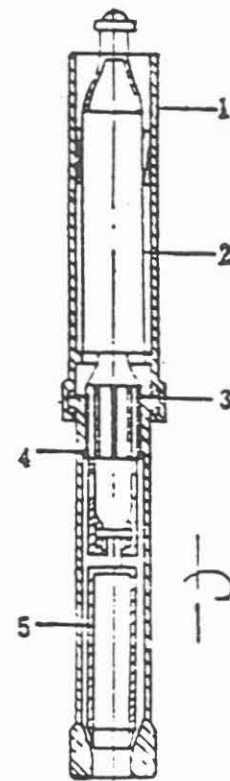

Fig.5 Prototype of PDM Driving Wireline Corer

1. PDM stator; 2. PDM rotator; 3. Spline; 4. Outer tube; 5. Inner tube

"Three-in-one" Wireline Coring System

Drilling, coring and reaming can be completed at the same time by combining the wireline coring system, PDM and retractable reamer (Fig.6)

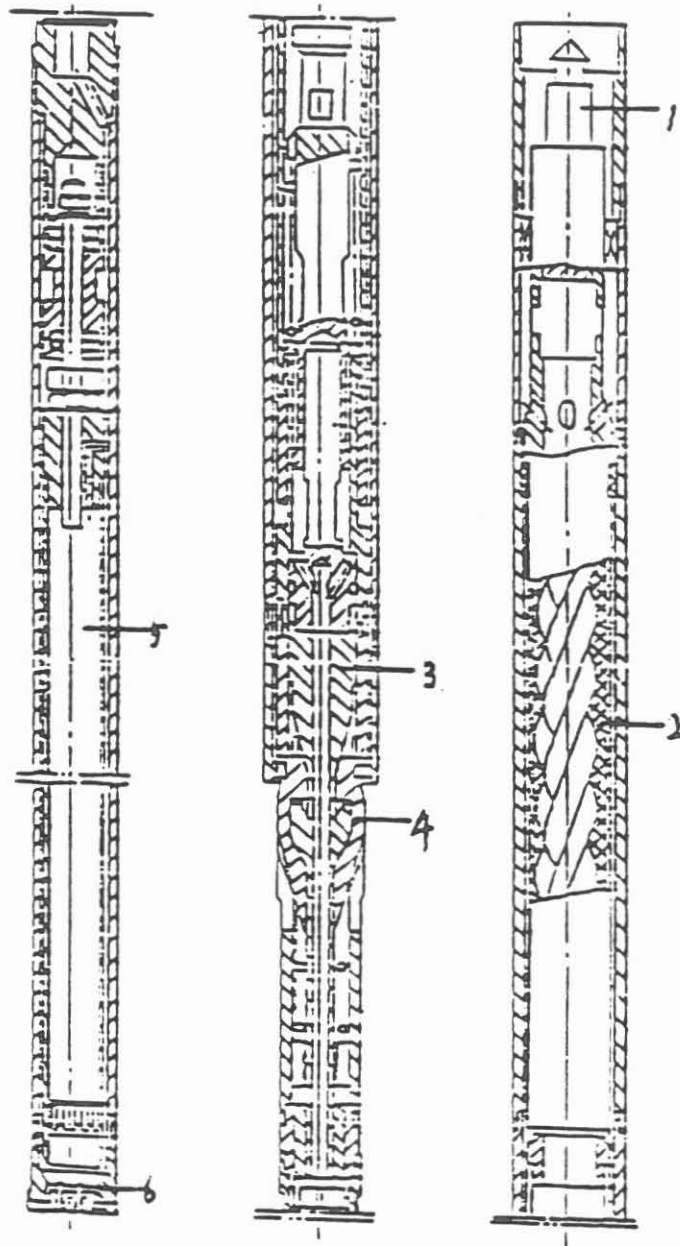

Fig.6 "Three-in-one coring system

1.Overshot; 2.PDM motor; 3.Retraction reamind bit; 4.Retraction device; 5.Double tube core barrel; 6.Diamond core bit

Table 11 Spec. of hydro-hammer driven el Coring Systems

symble	Type	features	O.D. tool	Hole dia.	pump rate m ³ / min	press. drop bar	freq. HZ	Imp. energy J.	length mm	wt. kg
SSC	SS59C	doubleacting,	58	59.5	0.05 - 0.10	5 - 20	30 - 40	5 - 10	5540	60
	SS75C	nonspring type	73	75	0.06 - 0.10	4 - 15	25 - 50	3 - 18	5672	90
	SS91C	positive acting type	88	91	0.06 - 0.10 0.07 - 0.14	7 - 18	15 - 40	8 - 40	5707	120
TKS	TK-60S	TK positive acting type	58	60 (59.5)	0.06 - 0.09	11 - 17	38 - 42	5 - 10	fresh water or low solid mud	
	TK-75S		73	75	0.06 - 0.12	10 - 19	38 - 50	6 - 18		
	TK-91S		89	91	0.07 - 0.14	10 - 18	40 - 53	7 - 20		

EXISTING PROBLEMS AND THE FUTURE TASKS

A group of geologists, geophysicists, geochemists, well-logging experts and geoanalysts have a deep understanding on the scientific and practical significance of scientific drilling. Chinese experts conducted nine large GGT Transects overcoming one difficulty after another, and are highly estimated by the International Lithosphere Program and the International Geophysical Circles. Selecting Continental Scientific Drilling drill sites in China are being conducted accelarately. Some drilling research programs are launched under the utmost difficult circumstances, but the general situation is good. Especially, some well-known geologists, like Professor Chang Bingxi (former vice-chairman of International Union of Geological Sciences), Professor Huang Jiqing and Professor Wang Hongzhen, et. al cognized Continental Scientific Drilling in China is a landmark of improving China's geoscience to a higher level. Professor Gu Gongxu, the famous geophysicist once wrote down "Suggestion on the Deep Drilling Program in China" (China Science and Technology No. 1, 1988). All of these express that outer settings is favorable for improving the execution of China's continental drilling project, and also express that these efforts are the mark of a strong begining.

It is keenly hoped that China's National Science and Technology Commission can establish a "China Continental Scientific Drilling and Lithosphere Dynamics and Evolution Programm", and establish an organization for leading and planning the execution of scientific drilling.

We are keenly hope that the International Lithosphere Program CC-4 Group can establish a permanent International Continental Deep Drilling Cooperation Plan at this international conference, and try their best to chose the area, which has global meanings, i.e., Qing-zang Plateau, etc., Through aiding or cooperating and international investing.

We hope to fill in the gaps in the field of scientific drilling, and to contribute to Global Lithosphere Program.

References

Current status of the organization work of the continental Scientific deep drilling in China, "Exploration Engineering", 1991

Special Issue of Information on Super-deep Hole Drilling by the Institute of Exploration Engineering, August, 1988.

On the General Procedure and Basic Requirements of Scientific Deep Hole Drilling, "Geological Exploration Technologies Abroad", No. 2, 1991.

Evaluation of Hammerdrill potential for KTB by W. Deutsch, C. Marx, H. Rischmüller.

Diamond Drilling handbook Edited by Lui Guangzhi 1992

**High quality coring for scientific purposes
on hard rock to 2000 m**

A. J. Beswick

Kenting Drilling Services Ltd.
Trent Lane, Castle Donington
Derby DE7 2NP / UK

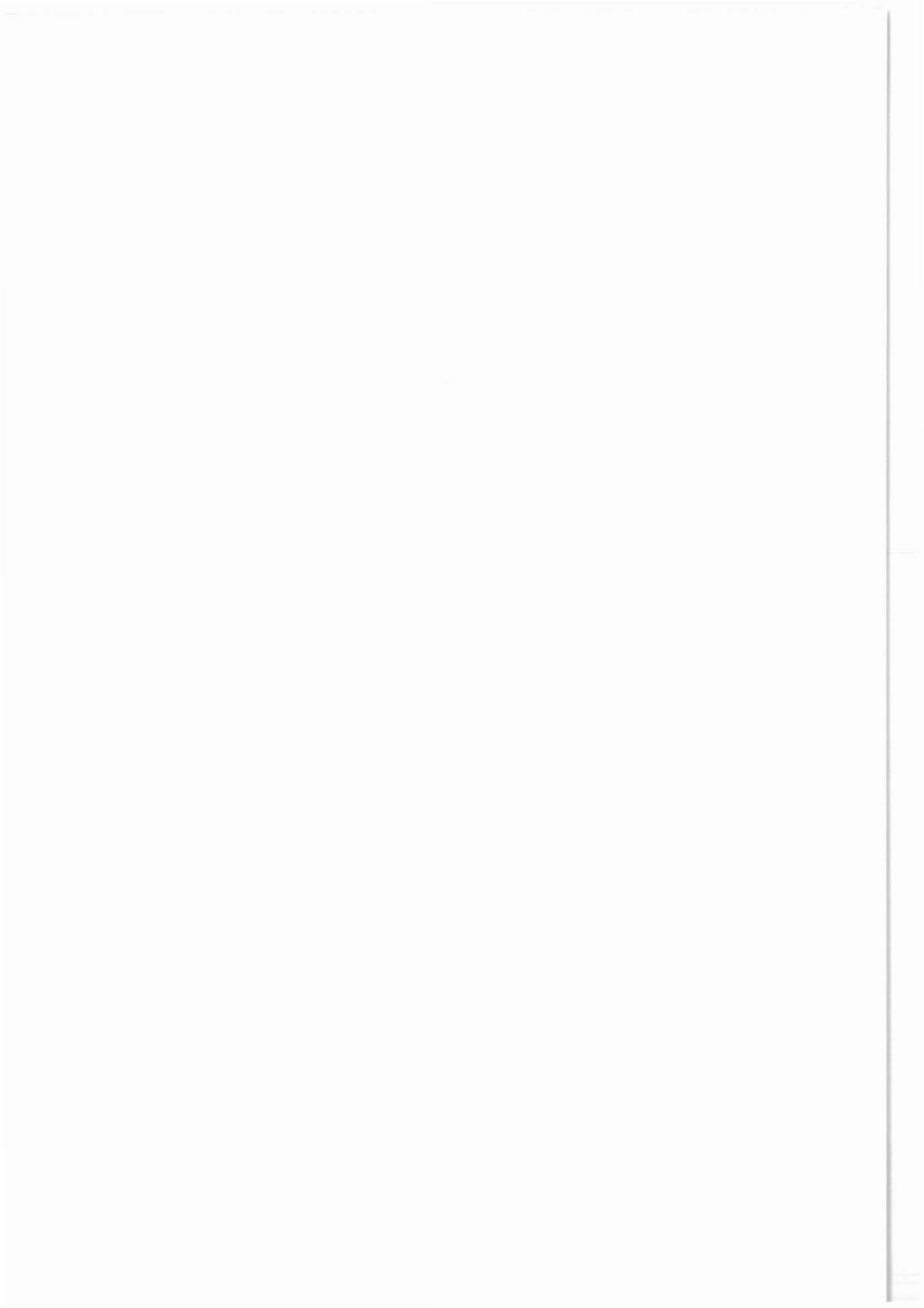

INTERNATIONAL CONFERENCE ON SCIENTIFIC DRILLING

HIGH QUALITY CORING FOR SCIENTIFIC PURPOSES ON HARD ROCK TO 2000 m

A.J. Beswick, Kenting Drilling Services Limited, UK

ABSTRACT

A programme of boreholes to depths up to 2000 m for the investigation of potential sites for the UK national repository for the disposal of low and intermediate level radio-active waste included the requirement for high quality continuous coring through a range of geologies. The requirement was for a 159 mm (6 1/4 in) minimum diameter hole for a comprehensive wireline logging programme and a suite of testing both during drilling and at the end of each borehole interval. These special requirements prompted the adoption of a blend of oilfield, mining and geotechnical exploration equipment and procedures to achieve the various objectives within the quality standards.

The principle objectives of the investigation are:

- * To define the geological structure and lithology to the depth up to 2000 m.*
- * To provide data on the hydrogeology, geochemistry and geotechnics.*

The geologies of the two sites are both variants of the crystalline basement under sedimentary cover scenario. At Sellafield, the generalised succession is principally a Permo-Triassic sequence comprising abrasive fine to medium grained sandstones, shales and poorly sorted breccias overlying Carboniferous Limestone and basement of Lower Palaeozoic age, the Borrowdale Volcanic Group. The Permo-Trias includes the St. Bees Sandstone, a formation noted for its abrasivity. The Borrowdale Volcanic Group comprises welded tuffs with interbeds of volcanic breccia and some intrusive andesite sills.

At Dounreay, a Devonian sequence of interbedded siltstones and sandstones, some 400-500 m thick, overlies a basement complex of metamorphic rocks of the Precambrian Moinian series. The Moinian rocks are very strong and adrasive with many quartz rich feldspar veins.

Four rigs have been used at sites at Sellafield, Cumbria, England and Dounreay, Highland Region, Scotland. Two rigs which commenced operations at Sellafield in 1990 were hybrid rigs based on standard oilfield diesel electric land drilling units modified to include hydraulic top drives, wireline coring winches, additional small triplex coring pumps and a secondary mud system dedicated to coring. Electromagnetic flow meters were used to monitor in and out flows and a sensitive electronic automatic drilling control system was installed on the rigs. A further hybrid rig was introduced in 1993 based on a small standard onshore trailer mounted mechanic unit which was also modified by adding a hydraulic to drive, electronic automatic drilling control system and wireline coring equipment.

At Dounreay, a large hydraulic top drive mining exploration rig was used which included a pipe handling robotic device to improve trip speed.

Continuous coring was carried out on three rigs with 139.7 mm (5 1/2 in) heavy duty mining wireline system with 159 mm (6 1/4 in) hole diameter and nominal 100 mm (4 in) cores. A 124 mm (4.8 in) hole size system with nominal 76 mm (3 in) was introduced on one rig in 1993. A PVC core barrel lining system was used to protect the core and assist in surface handling to minimise disturbance.

During drilling, environmental pressure measurements were taken at 50 m intervals to determine the in situ pressure profile and on the completion of each interval of drilling, a suite of straddel and full sector tests were carried out after a comprehensive wireline logging programme.

The boreholes were opened in the upper intervals to allow standard large diameter oilfield casing to be installed and cemented after each interval had been cored, logged and tested. Hole opening was carried out using conventional hole openers and rock bits with mud flush and with down-the-hole hammers and air or foam flush in the strong rocks at Dounreay.

Twelve deep holes were completed by early August 1993 representing over 16 500 m drilling and 11 750 m of continuous coring with 99.8% core recovery together with all associated logging and testing. Two further boreholes are in progress and the programme is expected to continue until 1995 and will include directionally drilled and slant holes. A purpose designed hydraulic slant hole drilling unit is under construction for part of the programme. Logging, and particularly testing, together with the associated tripping, account for a significant element of the overall time to carry out these special boreholes. A comprehensive quality assurance programme conforming to ISO 9002 is in operation.

Post drilling, a series of testing and long term monitoring programmes are in progress on several boreholes.

The work is similar in many respects to the general requirement for continental Scientific investigation boreholes. The highly successful integration of oilfield, mining and geotechnical exploration technologies for this special investigation programme owes much to the developments and experiences in scientific drilling over the last twenty years. Knowledge and equipment have been drawn from several projects for this programme. This demonstrates the importance of sharing experience in this specialised field, building on proven success and discarding those approaches which do not assure the desired results at a realistic cost.

This investigation programme is being carried out for the United Kingdom Nirex Limited by a Joint Venture known as KSW Deep Exploration Group comprising Kenting Drilling Services Limited (UK), Soil Mechanics Limited (UK) and Bohrgesellschaft Rhein-Ruhr mbH (Germany).

SELLAFIELD AND DOUNREAY INVESTIGATIONS

PRINCIPAL SCIENTIFIC ACTIVITIES

- * *Continuous coring and core logging*
- * *Use of lithium tracers to assess invasion*
- * *Comprehensive wireline logging and borehole imagery*
- * *In situ stress measurements (hydrofrac and overcoring)*
- * *Geochemistry sampling (pressurised samplers)*
- * *Environmental pressure measurements (during drilling)*
- * *Full sector and interval hydrogeological testing*
- * *Crosshole hydrogeological testing*
- * *Long term low flow testing from selected intervals*
- * *Long term monitoring using multipacker systems (Westbay)*
- * *Borehole radar*
- * *Acoustic monitoring*
- * *Rock mechanics laboratory testing*

DRILLING PERFORMANCE

- * *16 500 m drilled*
- * *11 750 m cored*
- * *1 952 m maximum depth*
- * *6 m long corebarrels*
- * *2 400 coring runs*
- * *5 m average coring run*
- * *99.8 % core recovery*
- * *1 900 operating days*

COREBIT PERFORMANCE

OVERALL AVERAGES

<i>Dounreay</i>	<i>84 m</i>	<i>400 m Devonian/Moinian</i>
<i>Sellafield</i>	<i>106 m</i>	<i>Permo-Trias/Borrowdale volcanics</i>

SELLAFIELD FACTS

<i>Worst average</i>	<i>53 m</i>	<i>Bit experimentation</i>
<i>Best average</i>	<i>204 m</i>	
<i>Best bit</i>	<i>433 m</i>	<i>Volcanics</i>

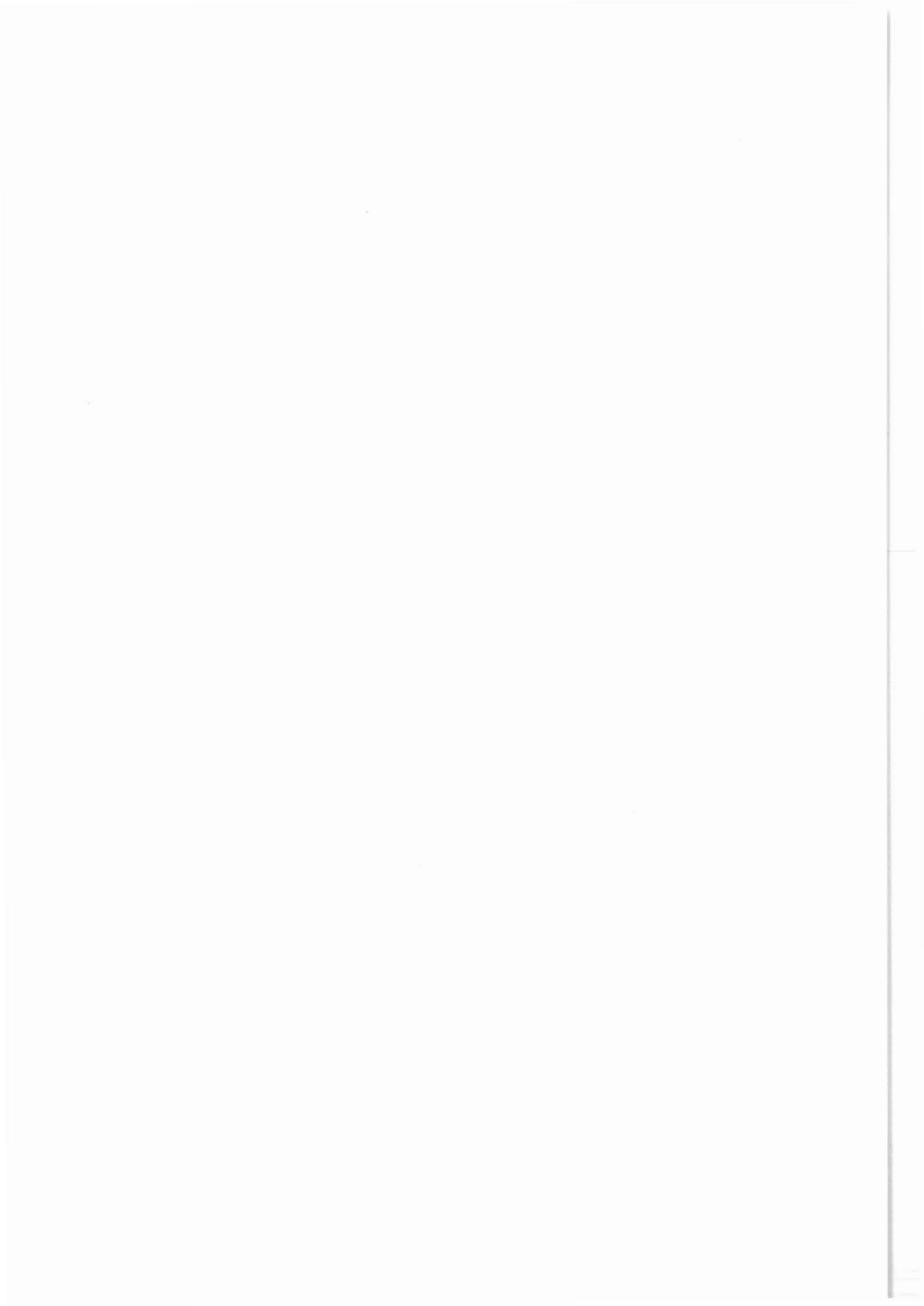

**Summary of deep slimhole wireline
drilling in South Africa**

A. J. Beswick

Kenting Drilling Services Ltd.
Trent Lane, Castle Donington
Derby DE7 2NP / UK

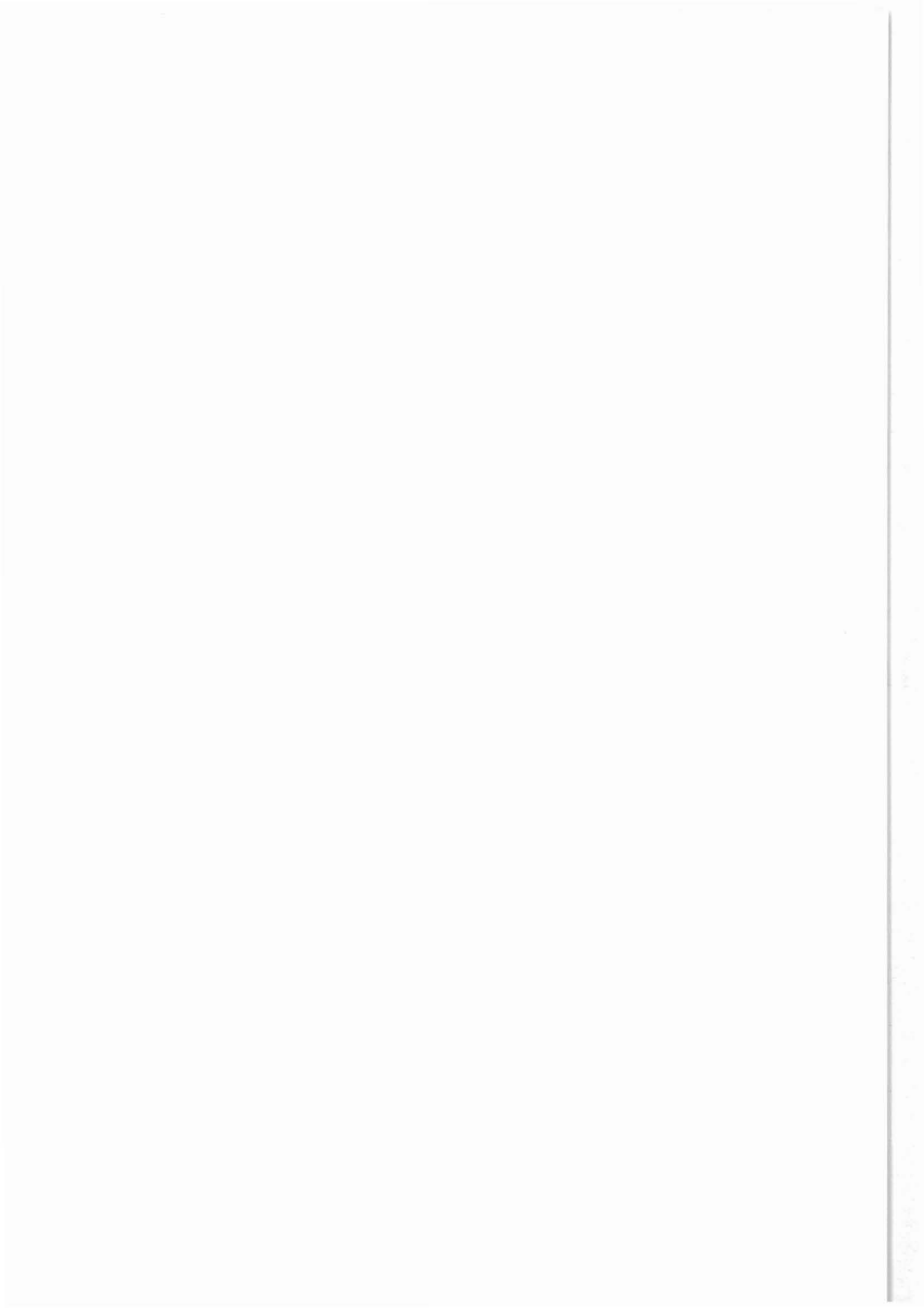

SUMMARY OF DEEP SLIMHOLE WIRELINE DRILLING IN SOUTH AFRICA

A.J. Beswick, Kenting Drilling Services Limited, UK

Parker oilfield rig and HS150 mining rig working on same site

Mining rig working in urban area

Drillfloor of hydraulic deep hole mining rig

Cross section of wireline aluminium vs. steel drill rod

Retrievable whipstock used for directional drilling

1 All deep holes are for **GOLD**.

Requirement for these deep cored mineral holes :

- * Shallower reserves exhausted - need to explore deeper
- * High grades makes mining economic, even at deep levels
- * Low temperature gradient makes mining at great depths possible
- * Geologists prefer continuous core for strat purposes

2 Typical depths and geology :

- * 2 500 m - 4 000 m deep holes are drilled routinely. Over 150 rigs in SA for this depth range.
- * Occasional holes of 5 000+ m. About 20 rigs in SA suitable for these depths.
- * Host rocks are usually conglomerate bands in very hard (500+ MPa uniaxial compressive strength) quartzite country rock. These are overlain by lavas, sandstones, mudstones, shales, etc.
- * Temperature gradients are very low, with TD temperatures at 5 000 m of less than 100°C.
- * Formations are generally stable, with no threat of instability, gas, overpressure or other hazards.

3 Typical hole design and geometry

- * For high speed and low cost holes are piloted using DTH air drilling through overburden and continuing as deep as possible 200 - 1500 m (groundwater influx is usual limitation to DTH drilling depth). Pilot hole is spudded 8 ½ in and finishes with 4 in ID casing

Spud 8 ½ in, install 6 ½ in ID casing.
Drill 6 ½ in, install 5 ½ in ID casing.
Drill 5 ½ in to maximum depth, install 4 in ID casing.
4 in casing usually (poorly!) cemented to surface
- * Rig up coring rig over hole. Drill to 600 - 2 000 m H size (4 in nominal) using HQ, CHD101 or similar wireline coring equipment. Install NW casing (3 in nominal ID)
- * Drill N size to TD
- * Multiple reef intersections are required. Conventional whipstocks are used.
Usually one or more long deflections required for improved sampling spread.
- * Contingency size of B (2¾ in) using tapered string and/or conventional (non-wireline) coring system.
- * Directional control is not usually a major criteria. Conventional and/or retrievable whipstocks are used if required.
Reliability and cost of slim mud motors has precluded their use to date. Also existing pump capacities of typical wireline mining rigs would not be adequate for mud motors.

4 Wireline coring systems

- * Most SA developed systems evolved from Longyear Q wireline design, all steel construction. Deeper depths require heavier duty systems - Longyear CHD & CUD, Huddy RSA 4K & 6K systems, etc. which are composite rods with friction welded tooljoints.
- * Notable exception is Aluminium Super, originally developed by Heath and Sherwood in Canada for slimhole oil and gas drilling. Pipe body is high strength 7075 aluminium alloy and tooljoints are 4130 steel fixed to alu body with Bakerlocked fine thread. Strength/weight benefit allowed continuously wireline cored hole of 5 466 m (world record) to be drilled with total "wet" string weight of less than 25 tons.

- * 6 metre corebarrels are typical. Fast wireline speeds of up to 200 m/min allow coring round trip times at 4 000 m of one hour.
- * Bits used are mainly diamond impregnated type. PDC bits suitable for hard/very hard formations offer exciting possibilities for improved production.

5 Rigs and surface equipment

- * Sullivan 50 is "workhorse", but it is oversize derivation of traditional design diamond drill rig (quill shaft and feed cylinders) converted from mechanical to hydraulic drive.
- * Some novel SA built rigs - hydraulic, modular. But most successful have been Heath & Sherwood HS150 rigs, Canadian designed for slimhole oil and gas. With alu rods they have been "pushed" to over double their original depth rating.
- * Typical deephole rigs have single prime mover of approx 300 HP driving series of hydraulic pumps. Stands of 60 or 90 ft. Hookloads of 70 - 150 tons. Rotation speeds for 3 in diameter are typically 700 rpm.
- * Drill fluids - simple polymer muds with viscosifier and cutting fluid are typical.

6 Economics of drilling

In the late 1970's deep holes of up to 4 000 m were being drilled but would typically take an average of one year per 1 000 metres!!!

This was because :

- * non-wireline methods were used (hence much rod tripping)
- * mechanical rigs (hence little control, resulting in much fishing)

By late 1980's deep holes were typically taking one month per 1 000 m due to equipment improvements, *plus improved productivity.*

Today a 5 000 m deep continuously cored exploration hole in SA costs about R 3 million, or about US\$ 900 000.

Note that rod costs are a very significant percentage of overall costs. Typical wireline rod life is only 8 - 15 000 m (although this probably represents the same total lifetime revolutions as oilfield API pipe!)

In the mid/late 1980's, in an attempt to further speed up exploration programmes, some SA mining houses engaged land oil and gas rigs from USA. They intended destructive drilling most of the hole using typical oilfield diameters, with selective conventional coring (about 4½ in dia) through reefs and other areas of interest. Despite great promises, they did not perform well, principally due to the very hard and abrasive formations giving very poor bit life. The poor production rates and high costs resulted in all such rotary drilling projects being abandoned. However the last hole drilled did achieve 3 800 m TD in about 35 days, which showed promise from the learning curve effect.

The interesting aerial photo of Parker's oilfield rig working alongside a mining HS150 rig on the same site was taken in 1988 on a shaft investigation site at Kloof Gold Mine in SA. On these directional 1 800 m deep holes the oilfield rig averaged 40 m/day and missed its target, while the mining rig averaged 30 m/day but hit the target zone. Comparative costs were not published, but I estimate total costs of the mining hole were 15 - 25 % that of the oilfield hole.

Perhaps this illustrates that, for hard rock drilling in benign areas, many of the world's scientific holes could be drilled cheaply by slim mining methods. Depth capabilities of these existing slim coring systems and rigs are 6 000 m, with probable ability to achieve 8 - 10 000 m with minimal development work.

Some remarks to mud technology and wellbore stability

J. F. Holtrop

van Alkemadelaan 350
NL 2597 AS s'Gravenhage
The Netherlands

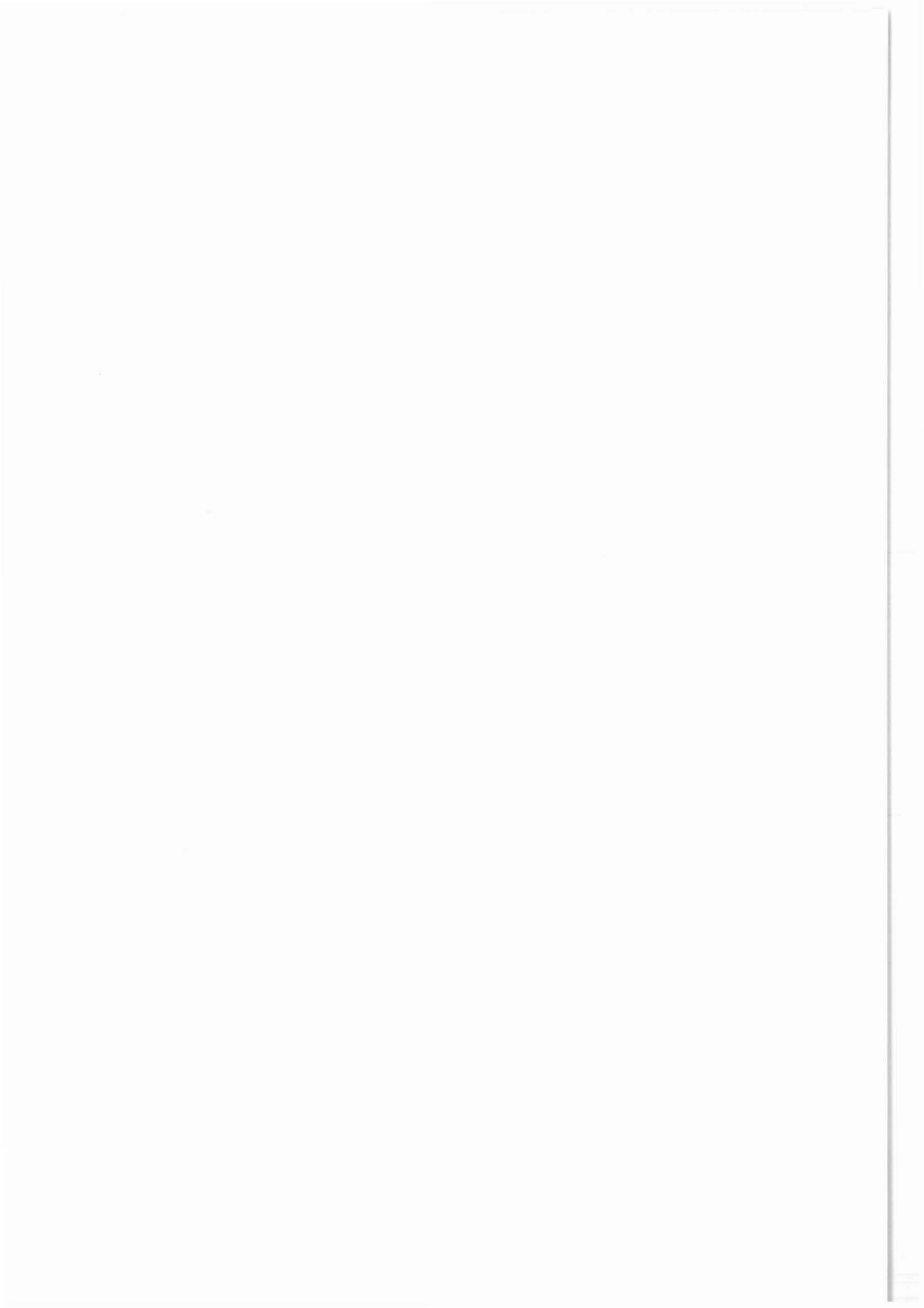

Some Remarks to Mud Technology and Wellbore Stability

J.F. Holtrop

Borehole stability in deep wells is in particular determined by:

- 1) The rock mechanical aspects of the rocks in which the well is drilled.
- 2) The interaction between the drilling fluid and the borehole wall.
- 3) The stability of the mud itself.

Ad. 1) Rock mechanical aspects.

Rock failure develops when the relation between the maximum and the minimum main stresses within the rocks becomes such that a certain threshold value is surpassed, whereafter the rock commences to fail.

Failure of elastic material can be visualized with the Mohr's circle and the Navier-Coulomb Failure Hypothesis. For vertical wells and rocks which behave as elastic material our calculations are not that difficult. However, the calculations become complicated when plastic conditions and borehole deviation have to be included. Shell's E&P laboratory at KSEPL in The Netherlands incorporated these conditions in a three dimensional computer model, called STABOR. When the KTB well experienced serious breakouts, the STABOR model was used to check whether the mudweight (then 1,06) was still sufficient. Based on the rock data available at that time STABOR indicated that the mudweight was too low. An increase of the mudweight did indeed stabilize the hole.

Ad. 2) Interaction between drilling fluids and the borehole wall.

Borehole instability and resulting problems are often encountered when shales are being drilled. Shales have permeabilities of 10^{-6} and 10^{-12} Darcies. Due to these low permeabilities normal filtercakes are not built up. Under most drilling conditions the fluid pressure in the borehole is higher than the fluid pressure in the pores and fractures within the rocks surrounding the borehole. The result is that a pressure gradient develops. When drilling with an overbalanced mud and in the absence of a filtercake, fluids penetrate into the micro fractures in the shales, which with

time leads to an unstable borehole wall. Studies at KSEPL clarified this mechanism. A study of the impermeable gneiss and amphibolite drilled in the KTB-well showed that the gneiss and amphibolite do have very small permeabilities as a result of micro- fractures. Therefore, in the absence of a filtercake, it might be possible that gneiss and amphibolite react like shales in unmetamorphosed sections. Drilling in overbalance could then similarly lead to an unstable borehole wall. An uncontrolled weighting-up of the mud could destabilize the borehole wall even further.

It shows that solving the problem by increasing the mudweight, as outlined under ad.1) may aggravate the problem as given in ad.2).

Ad. 3) Stability of the mud itself.

At higher temperatures (say above 120 degrees C) the rheological properties of the common waterbase muds deteriorate quickly and a drop in viscosity or in thixotropy may cause the cuttings to settle out prematurely. This in turn may lead to stuck pipe.

KSEPL developed formate brines which may overcome the temperature dependency of the common waterbase muds. Formate brines to which such viscosifiers as Xanthan gum, a microbial polysaccharide, are added, show excellent mud-properties and remain stable at temperatures above 175 degrees C. The S.G. of these brines can be adjusted by varying the content of respectively sodium-, potassium-, or cesium formates. KSEPL is working to improve these muds even further.

Summarizing, the three examples given above show that research carried out by the E&P laboratories of the oil companies can assist scientific projects like the KTB deep drilling project. The objectives of the oil companies to get involved in certain fields of research may be different, their results may serve both, the oil industry as well as research projects of a different nature and with different objectives.

It is therefore important to continue to maintain good contacts and a good dialogue with companies operating in the oil and gas industry.

Author's Address:

Prof. Dr. J.F. Holtrop
van Alkemadelaan 350
NL 2597 AS 's-Gravenhage
The Netherlands
Tel.: 0031-70-3282276

**Drilling and coring technologies for
CSD products**

J. C. Rowley

Pajarito Enterprises
3 Jemez Lane
Los Alamos, NM 87544 / USA

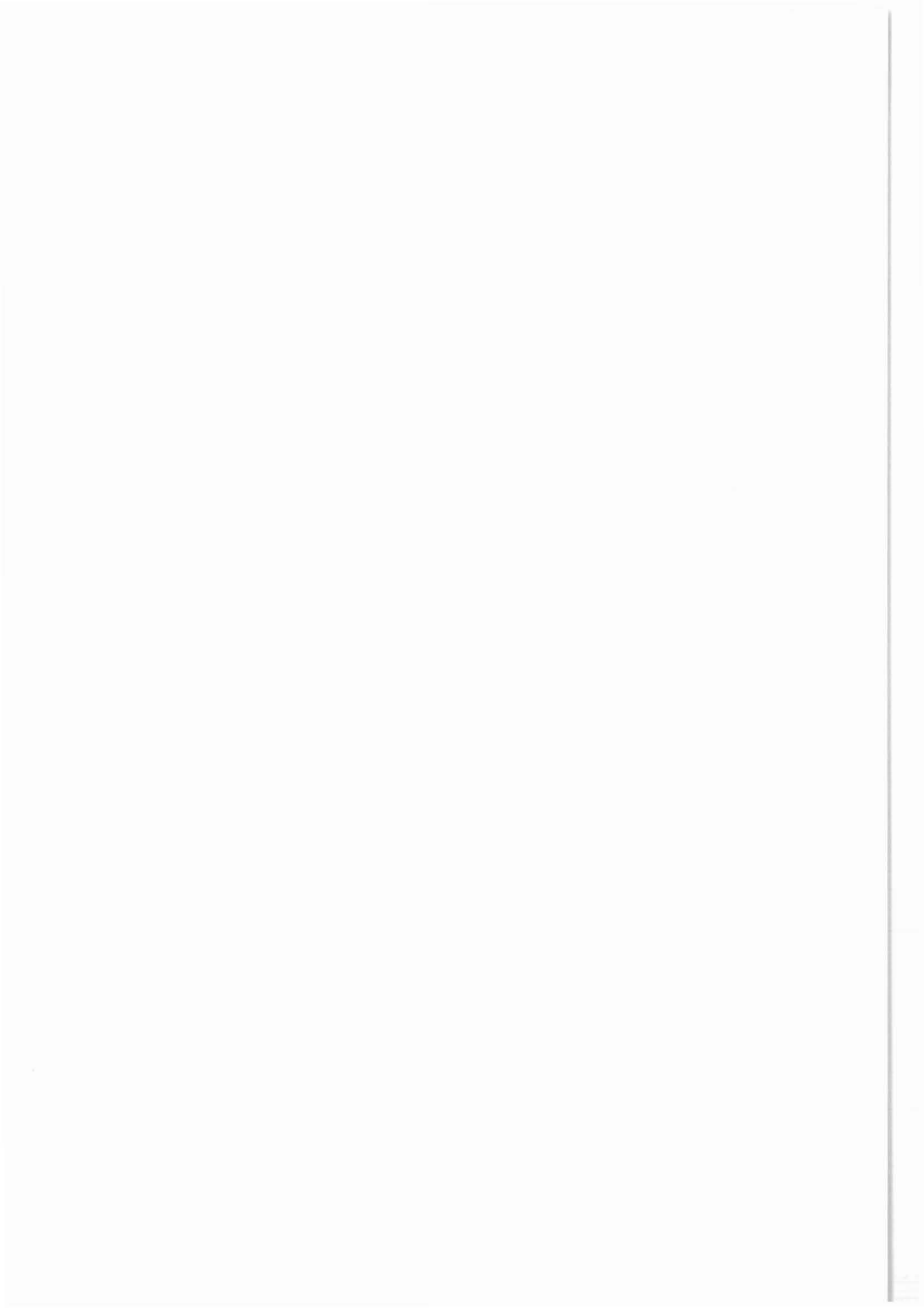

DRILLING AND CORING TECHNOLOGY FOR CSD PROJECTS

By: JC Rowley, Pajarito Enterprises
Los Alamos, NM 87544 USA

Summary. This report is an expanded version of a presentation at the International Conference on Scientific Continental Drilling, Potsdam, Germany (ICSD); for the Technology sessions. The material is a selection of recent advances in core-drilling technologies, and related topics of potential interest to those planning and devising strategies for Continental Drilling (CSD) projects. It is a follow-on to previous descriptions of technology advances, needed improvement, and research needs for effective conduct of CSD geoscientific projects. Some trends in the areas of core bits, hammer coring, ultra-deep core-drilling system concepts, and the example of a strategy for the proposed USA San Andreas Fault Zone (SAFZ) CSD project. This latter project envisages a set of deep lateral, slant core holes across the near-vertical SAFZ, and relates these sampling and testing requirements to the current advances in horizontal, multiple-legged completion drilling operations in the petroleum and geothermal industries. The need for CSD projects to be involved with experienced and knowledgeable drilling engineers and coring technology experts early in the planning phases, as well as continuously during the progress of a CSD project has been clearly demonstrated. This is especially true for projects with requirements for advanced or unusual scientific and technical goals; and especially for ultra- or super-deep targets.

Introduction

Previous reviews of core-drilling technologies prepared by engineers interested in CSD projects (Rowley 1985; Rowley and Schuh 1988; Rischmuller et al. 1990 and Rowley 1992) have attempted to describe technology trends, or describe the needed technology improvements or new equipment necessary to achieve the objectives of several CSD projects. The importance of the suggested strategies and developments are

amply illustrated by Walton (1987), Urabe et al. (1992), and Chur and Oppelt (1990). This KTB pilot core hole (KTB Vorbohrung, KTB-VB) illustrates the successful efforts to design and develop a scientific coring system to meet the scientific objectives of core recovery; and recorded a significant level of performance of core bit penetration rates, bit life, and excellent core recovery rate (98%) with high quality. However, it seems clear that even this significant core-drilling technology could have been improved greatly by the inclusion of a suitable steering or borehole trajectory control mechanism for the deeper sections of the KTB pilot hole. The KTB-VB could likely have been carried to greater depths than the notable 4 km achieved, had the hole deviation and resulting frictional drag not occurred.

The need for an ultra-deep core-drilling system for ultra-deep CSD projects has been amply illustrated by the Kola super-deep hole, UD-3, the current difficulties with the main KTB borehole (KTB-HB) and the projected core drilling needs for the proposed Japanese JUDGE (Japanese Ultra-Deep Geoscientific Experiment) project (Urabe et al. 1992) that calls for an ultra-deep core hole through the Eurasian Plate and into the contact zone with the Philippine Sea Plate, and finally penetrating the Philippine Sea Plate. This scientific target will require the consideration, design, development, and fielding of an advanced core-drilling system for the projected 7 to 10 km depths. Such systems had been discussed for the KTB project (Chur et al. 1990), but they were not realized. A concept for the planning of the JUDGE drilling strategy, and an ultra-deep core-drilling system (Rowley 1993) have been suggested.

The technical requirements for the proposed USA San Andreas Fault zone CSD project have been set forth, (Yunker et al. 1994), and it is proposed to use improvements and extensions of current horizontal and lateral core-drilling techniques to obtain samples and conduct tests that traverses the near-vertical SAFZ. In addition it is suggested that multi-legged, or multi-branched lateral boreholes can be drilled from a single vertical hole and achieve considerably more flexibility and increase the amount of scientific measurements, tests, and fault characterizations than with a single slant hole. This approach avoids the possibility that some tests, such as fluid pore pressure determinations would interfere with one another.

Core Bits

A recent development of large size thermally stable diamond (TSD) compacts (Clark et al. 1992) has made possible improved impregnated core bits that include axially oriented TSD pins, Figure 1. This core bit would be expected to improve even further the excellent bit life (48 m) and rate of penetration (ROP) of about 1.7 m/h achieved on the average for the KTB-VB. If the field data reported by Clark et al. (1992) are typical of the improvements, Figure 2, then bit life and ROP may be expected to increase by perhaps

a factor of two, or more. Also these large TSD cutter blanks will permit design and operation of both drill and core bits that should be much more aggressive and provide considerably more power (Cohen et al. 1993 and 1994) to be transferred to the rock cutting process for even the extremely hard crystalline rocks encountered in deep CSD projects by use of high-powered downhole motors. This will allow consideration of coring assemblies described by Miller and Huey (1992), that use downhole motors that can be wireline deployed. This possibility could then provide for a downhole directionally controlled assembly that could extend the depth range of systems like that devised for the KTB-VB. This approach would give further performance gains in ROP, but core bit life extensions require further development. Increased use by the oil and gas industry of slim-hole coring technologies (Armagost and Sinor 1994) indicates a positive trend for lower costs for CSD drilling projects.

Project Strategies

Walton (1986), Rischmuller et al. (1990) and Rowley (1993) have illustrated the drilling planning and strategies for different ultra-deep, scientific, core-drilling projects. It is stressed that a strategy of coring shallow pilot holes, (Hill 1985 and 1993) followed by a very deep core hole as a second stage, and finally the core drilling of a third phase to ultra-depths, to targets of 10 km or deeper has many benefits. This approach to the drilling technology developments and their sequential deployment allows for the achievement of a broad variety of science objectives within the three stages or phases. A key element is the reduction of the drilling risks at each stage by providing advance geologic information for the subsequent drilling planning for the next stage. This approach was followed by the KTB CSD project and is illustrated by the very preliminary strategy and planning for the JUDGE project (Rowley 1993).

The JUDGE project strategy, shown in Figure 3, where it is suggested that an array of shallower core holes precede the drilling of the deep, (about 7 km), pilot core hole. This will allow a better definition of the major target of the JUDGE project, the contact between the Eurasian and Philippine Sea Plates presumed to be at a depth of approximately 10 km. It is estimated also (Urabe et al. 1992) that the temperatures at that depth may be about 500°C. Also it is noted that the ocean crustal plates are thought to be of complex structures and materials of relative recent geologic ages, and the characteristics of such rock masses relative to borehole stability are probably not favorable. Thus, it is imperative that for all such ultra-deep CSD projects, the development of a deep coring system is essential for success. It is recommended that core-drilling by turbocorers or hammer-percussion core-drilling systems should be the developments pursued. It is also judged that a core-drilling system be considered that will allow drilling under unstable borehole

conditions. One possible method is to use a so-called dual-wall drill string (Long et al. 1993 and Rowley 1993); as sketched in Figure 4. The hollow shaft turbocorer was proposed and developed for the Mohole project and seems completely feasible. The use of hammer-percussion core-drilling systems seems to have great potential too, and has been explored for use in the KTB-HB (Deutsch et al. 1990 and Guangzhi 1992); however, it was not developed far enough to be deployed in the KTB-HB. Work should continue on both approaches, and probably on other promising concepts as well if suitable, effective, ultra-deep core-drilling systems are to be developed for future CSD projects.

Drilling Plan and Strategy for San Andreas Fault Zone

The initial drilling plan and sequential coring strategy for the proposed SAFZ CSD is shown in Figure 5. A series of possibly four shallow slant core holes will be drilled across the fault during the site evaluation selections at four different sites along the 1300 km length of the San Andreas Fault. The stage I will then consist of an intermediate pilot core drilled hole to perhaps 3 km depth. From that depth, three slant branch drill, test, or core holes might be considered as traverses across the near vertical fault line. As shown in Figure 6, one traverse could be drilled, logged, cased and cemented, and subsequently perforated for testing of fluid characteristics such as pore pressures. A second traverse might be a core hole, and the third a core-drilled hole with numerous through core-bit packer runs for fluid samples, fracturing, and rock property measurement conducted immediately after each core run. Such multiple lateral, or branched completions are common in petroleum and geothermal drilling (Steffen 1993; Henneberger et al. 1993 and Hayes and Smith 1994). The core-drilling method might best be considered to be similar to the top drive, high-speed, narrow-kerf wireline system used for the KTB-VB. Drilling of the deeper two phases and any single or multiple branched core traverses would undoubtedly require a special ultra-deep drilling system developed for those applications.

Discussion and Conclusions

The trends in drilling technology improvements favor the increase in performance and effectiveness of future CSD projects. These areas are in core bit improvements, selection of a drilling strategy and advance planning, and the increased flexibility of directional coring across near-vertical target structures. The precedents set and development program successfully conducted by the German KTB and earlier the Russian Super-Deep core holes, have provided guidance for future CSD project planning research and development needed for successful drilling campaigns.

References

- Armagost WK and Sinor LA (1994) The Successful Introduction of Anti-Whirl Bit Technology to Conventional Coring Operations, IADC/SSPE 27473, February, 1994 IADC/SPE Drilling Confr., Dallas, TX USA
- Chur C, Engeser B and Wohlgemuth L (1990) KTB Pilot Hole-Results and Experiences of One-Year Operation in Fuchs K, Zlovsky YA, Kristov AI and Zoback MD Eds. Super-Deep Continental Drilling and Deep Geophysical Sounding, 180-190
- Chur C and Oppelt J (1993) Vertical Drilling Technology-A Milestone in Directional Drilling, SPE/IADC 1993 Drilling Confr. SPE IADC No. 25759 Feb., Amsterdam Netherlands 789-802
- Clark IE, McKensie KA and Tomilson PN (1992) Field results in drilling & mining with SYNDAX3, Ind. Diamond Rev 4: 186-191
- Cohen J, Maurer WC and Wescott P (1993) High power TSD bits, Proc Asme/ETCE Drilling Tech. Symp., 10 p
- Cohen J and Wescott P (1994) Improved high-powered TSD bits, to be publ in Proc ASME/ETCE Drilling Tech Symp.
- Deutsch U, Marx C and Rischmuller H (1990) Evaluation of hammer-drill for KTB, in Fuchs K et al. Eds., 311-321
- Guanghi L (1992) A preliminary plan for the continental scientific drilling in China (CSDC), Sci. Drilling, 3: 215-221
- Hayes LA and Smith RC (1994) The Lateral Tie-Back - The Ability to Drill and Case Multiple Laterals, SPE/IADC Paper No. 27436, 1994 IADC/SPE Drilling Confr., February, Dallas, TX USA
- Henneberger RC, Quinn DG, Chase D and Gardner MC (1993) Drilling and completion of multiple legged wells in the northwest Geysers, Geoth. Res. Coun. Trans. 17:37-42
- Hill DG (1985) Maximizing geothermal drilling information with wire line geophysical logs, Geoth. Res Coun. Bull 14:19-22
- Hill DG (1993) Cost effective use of slim-hole drilling and logging to evaluate and develop geothermal prospects, Geoth. Res Coun. Trans, 17: 425-430
- Long R, Wondrly D and Wright E (1993) A drilling and coring system for studying unsaturated zone in situ conditions. ASME/ETCE Drilling Tech. Symp, ASME No 93-PET-10:28
- Miller UE and Huey DP (1992) Development of a Mud-Motor-Powered Coring Tool. Offshore Technology Confr., May O.T.C. No. 6865, Houston, TX USA 479-488
- Rischmuller H, Jurgens R, Marx C, Oppelt J, Deutsch U and Sperber A (1990) New strategies for ultra-deep coring crystalline bedrock, in Fuchs K, Zlovsky YA, Kristov AI, and Zoback MD Eds. Super-Deep Continental Drilling and Deep Geophysical Sounding, 273-292
- Rowley JC (1985) Drilling technology for hot crystalline rock, in Raleigh BC, Observation of the Deep Continental Crust Through Drilling I: 273-308
- Rowley JC and Schuh FJ (1988) Experience from crystalline rock drilling and technology directions for effective ultra-deep core-drilling, in Boden A & Eriksson Eds. Deep Drilling in Crystalline Bedrock, 2:13-53
- Rowley JC (1993) Core-drilling strategy and design concept for ultra-deep scientific projects, 1993 proc ASME/ETCE Drilling Tech. Symp. Houston, TX, NO.93-PET-10:28 pp.

Rowley JC (1994) Design concept for an advanced geothermal drilling system, 1994 ASME/ETCE drilling tech symp proc., to be publ., New Orleans, LA, January

Steffen MW (1993) Designing and drilling multiple leg wells in the Geysers, Geoth. Res. Coun. Trans, 17:53-59

Urabe T, Tanaka S, Kiya Y and Soejima T (1992) Japan ultra-deep geoscientific experiment (JUDGE) project: an overview, Proc. ASME/ETCE Drilling Tech. Symp, PD 40: 89-94

Walton M (1987) Core drilling technology for ultra-deep holes, in Behr HJ, Stehli Fand Vidal H Observation of the Continental Crust Through Drilling II:160-169

Yunker LW, Hickman SH, Zoback MD and Cooper G (1994) Drilling, coring sampling and monitoring requirements for the San Andreas Fault Zone drilling project, 1994 ASME/ETCE Drilling Tech. Symp proc., New Orleans, LA

CAPTION LIST

Fig. 1. Schematic cut-away sketch of TSD enhanced diamond impregnated core bit (Clark et al. 1992)

Fig. 2. Comparison plot of TSD pin enhanced bit life with companion standard impregnated core bits. Earlier data compilation from Rischmuller et al. (1990) are also shown. Bit life: □ without pins, Δ with pins.

Fig. 3. Schematic sketches of a dual-wall coring system (Long et al. 1992). Basic bottom hole assembly with roller-cone core bit and motor drive, capable of wireline coring ahead and then reaming the core track.

Fig. 4. Proposed 3-phase drilling strategy, JUDGE CSD project. Phase I: Drill an array of slim and core holes with subsurface modeling as used in geothermal exploration (Hill 1985 and 1993). Phase II: Drill a straight, vertical borehole to 7 km. Phase III: Use special dual-wall core-drilling system to core drill to target at about 10 km (Urabe et al 1992).

Fig. 5. Schematic of proposed fault zone CSD project. An inclined, shallow slant core hole would be followed by a 3 km deep pilot hole and then a 10 km deep borehole. Slant core holes would be drilled at about 3, 6 and 9 km (Yunker 1994). These slant traverse core holes might be considered for multiple lateral drilling.

Fig. 6. Illustration of multi-leg or multi-branch traverses. For example: (a) A drilled hole cased, cemented and subsequently cemented; (b) A core hole traverse; and (c) a test core hole with through-core-bit packer testing.

Figure 1

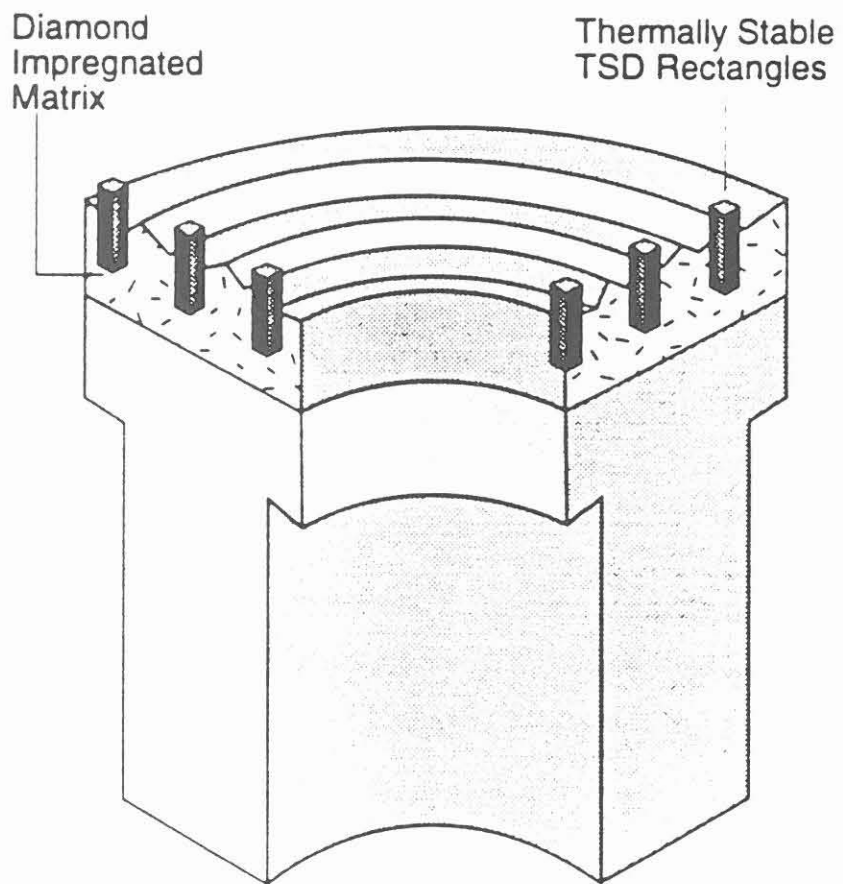

Figure 2

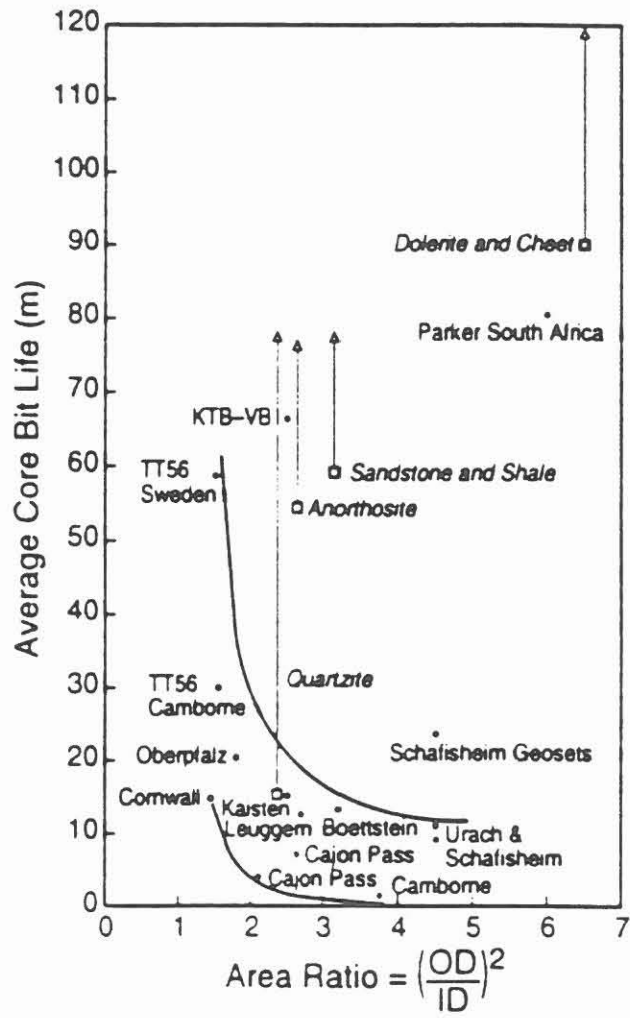

Figure 3

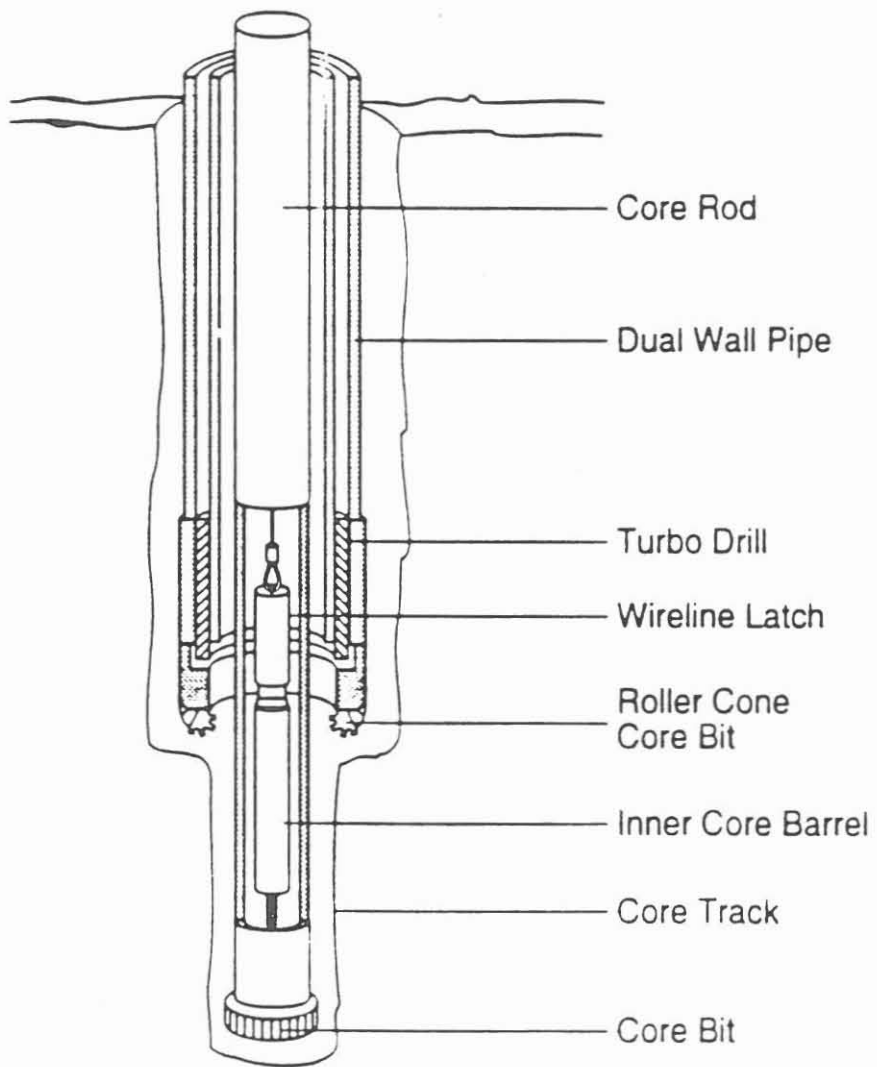

Figure 4

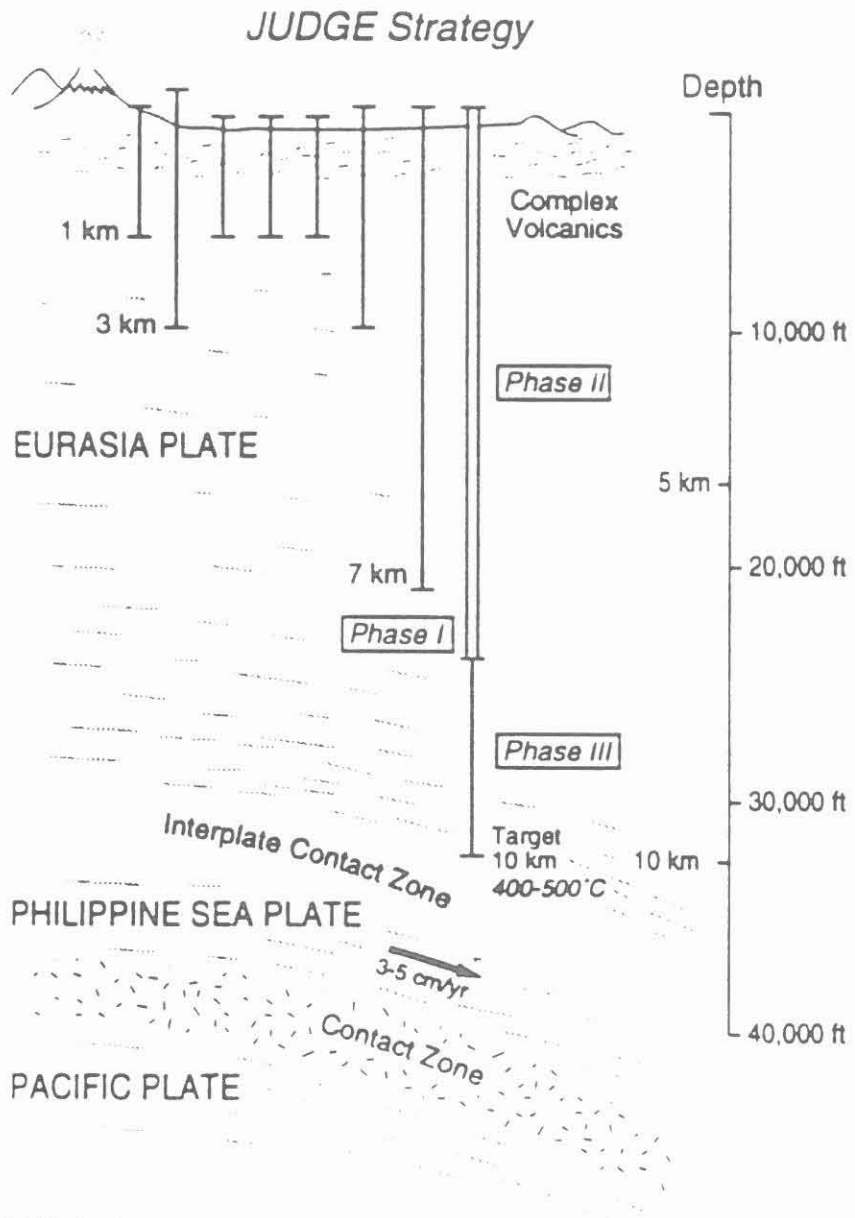

Figure 5

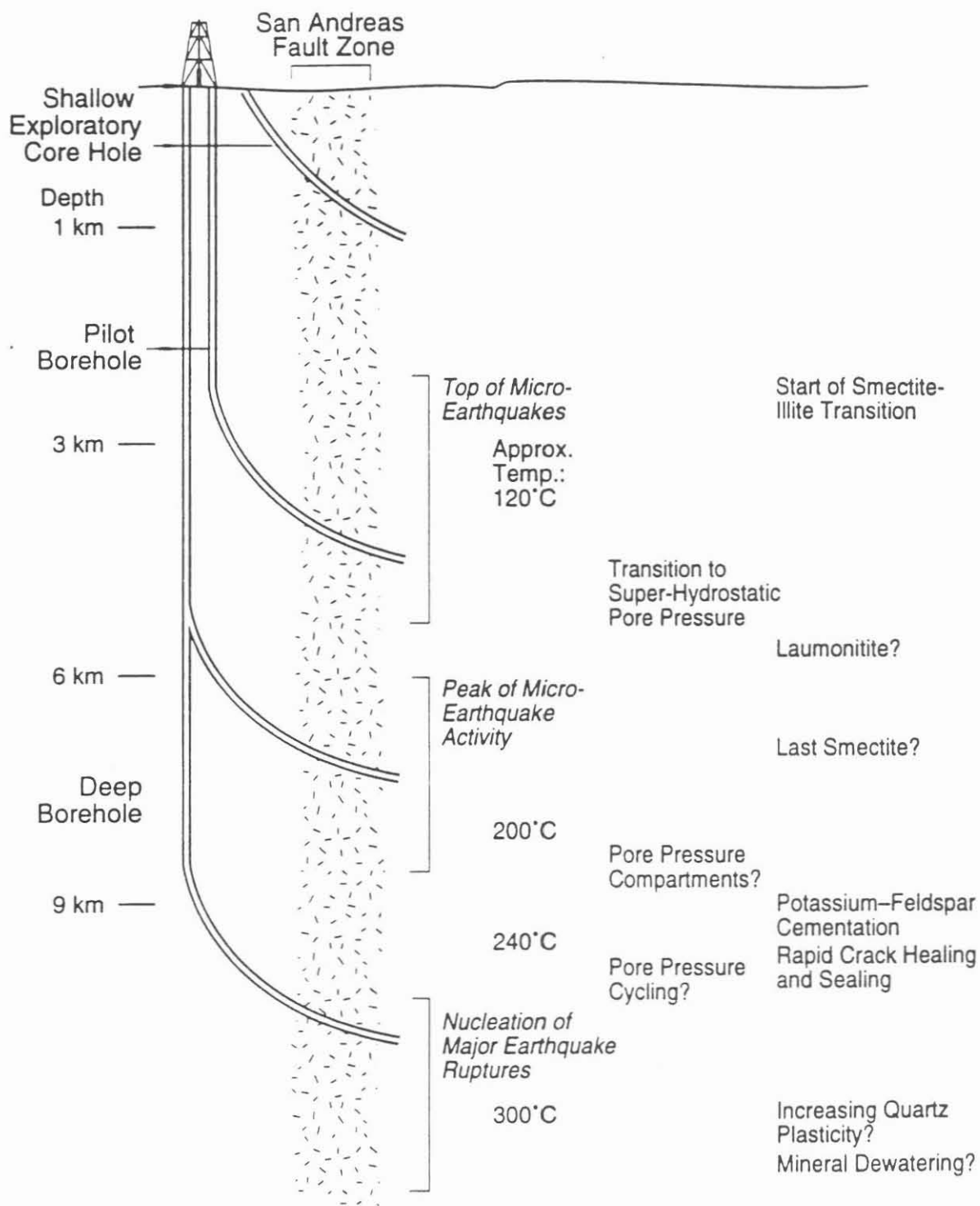
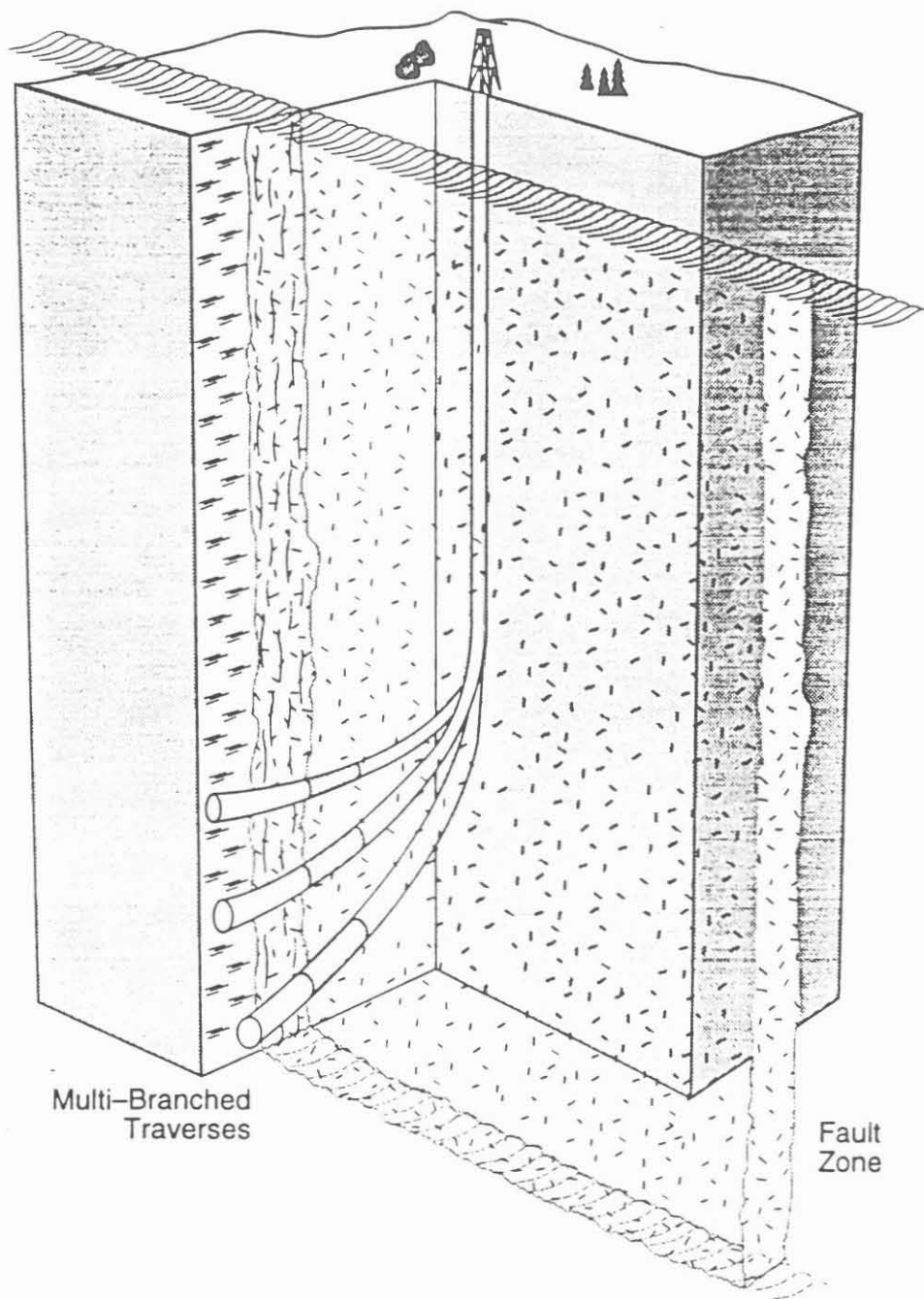

Figure 6



**Scientific drilling, sampling and testing
up to 5000 m depth**

H. Gloth

TU Bergakademie Freiberg
Institut für Bohrtechnik und Fluidbergbau
Agricolastraße 22
09599 Freiberg / Germany



TU Bergakademie Freiberg
Institut für Bohrtechnik
und Fluidbergbau

Scientific drilling, sampling and testing up to 5000 m depth
H. Gloth

Arrangement

1. Introduction
2. Scientific drilling up to 5000 m depth
 - 2.1. Suitable drilling methods for scientific drilling
 - 2.2. Hole geometry selection
 - 2.3. Drill pipe, BHA and bits
 - 2.4. Drilling mud
 - 2.5. Rig selection and pipe handling
3. Acquisition of information
 - 3.1. Drilling process measurement, MWD and LWD
 - 3.2. Cores and Cuttings
 - 3.3. Geophysical measurement in the hole
 - 3.4. Tests and sampling of liquid and gaseous samples up to 5000 m depth
 - 3.4.1. Decision on test and sampling ranges
 - 3.4.2. Possible tests in scientific drilling
 - 3.4.3. Sampler and sampling
4. Important problems and possible further developments in drilling, testing and sampling in scientific holes

1. Introduction

The general and special goals of scientific drilling dictate conditions, which in many ways are different from the goals of other boreholes such as exploration and exploitation wells for oil and gas or boreholes for mining exploration.

Taking into account the goals of scientific drilling the technique and technology for which must be specially chosen, it becomes evident that scientific drilling involves high demands on the drilling technique and technology.

The most important point is the achievement of the scientific objectives, i.e. the acquisition of information by rock and fluid sampling, extensive geophysical measurements, tests and the acquisition of sufficient physicochemical data. This acquisition of information and the drilling process must be supported by extensive technical measurements. The time requirements of a scientific hole are, of course, greater than the time needed for drilling a commercial hole. The extreme demands, made on the drilling technique in scientific drilling, however require and enable a development push in the field of drilling, as the KTB project has impressively shown. For scientific drilling, the most progressive drilling technique will always be just good enough. Experience has demonstrated that for the successful realization of a scientific hole almost all scientific and technical branches of knowledge must work closely together. In a related paper Prof. Betz has called this necessary cooperation as a "Symbiosis in the best sense of the word" - I believe that this is a correct formulation.

2. Scientific drilling up to 5000 m depth

Scientific holes are drilled, as you know, adequate to the goal to very different depths. I was asked to say some about holes up to 5000 m depth. I very much support a separate handling of the depth area up to 5000 m, because in this range it still makes sense to ask: "Which drilling technique and drilling technology has to be applied?" The answer to this question will have enormous effects on the costs, the required time and the quality of the hole in the sense of the pursued technical and scientific goals. As you know, the wireline drilling technique was chosen for the drilling of the KTB Vorbohrung to a depth of 4000,1 m. This technique was modified and very successfully used. I am sure you now, that a depth of 5,422.76 m was reached by the wireline drilling technique with a final diameter of 3" (76 mm) in South Africa in May 1986 /32, 33/. Of course, the question of the hole diameter has to be asked again in scientific drilling.

2.1. Suitable drilling methods for scientific drilling

In the depth range up to 5000 m, excluding the very shallow

holes, the choice of drilling technologies includes rotary drilling and the wire line drilling, which was applied in the KTB-Vorbohrung. In commercial drilling, especially in exploration drilling for oil and gas, the possibilities of a substantial reduction of time and costs by the reduction of the hole diameter, has been discussed and tested for a long time. An essential reduction of time and cost is of course very interesting in scientific drilling, especially in view of their high time requirement. It is well known that cuts had to be made on the KTB project partially affecting desirable tests, which cannot be planned exactly from the beginning. The smallest possible diameter of a scientific hole depends first of all on the available measuring equipment. For the KTB Vorbohrung a diameter of 6" (152,4 mm) had to be chosen. The geophysical standard equipment is dimensioned for a drilling diameter of 8 1/2" (215,9 mm). With reference to the drilling technology reduction of the diameter below 6" (152,4 mm) absolutely possible. However, it has to be borne in mind that a reduction in diameter can also provoke drilling problems and disadvantages, such as strength problems, a reduction of core diameter and a reduction of technical reserves if an additional casing proves necessary.

Of course, there is no need to prove that rotary drilling is not suitable for a significant reduction in diameter in scientific drilling up to 5000 m depth.

In the selection of the drilling technique and drilling technology for scientific drilling up to 5000 m depth, with the normally desired long core sections, the wireline drilling technology will normally be chosen. The experiences gathered in the KTB-Vorbohrung have unambiguously confirmed this.

2.2. Hole geometry selection

The hole geometry is selected on the basis of the required safety parameters in dependence on the geological conditions, the goals of the drilling and the possibilities of the drilling technology. In a way, the geological conditions and the goals of the hole are fixed conditions, so the reserves can be mobilized only by innovations of the drilling technique. It must be carefully analysed to what extent the open hole ranges can be enlarged by a suitable drilling mud, to possibly economize one casing string; on the other hand the selection of the drilling mud does of course not only depend on its technical tasks but also its properties which influence the aquisition of information.

Drilling depth of up to 5000 m can be handled with the available pipes. The use of high-frequency-welded pipes should be checked, which can be made with about the half the tolerance of mill pipes und which therefore offer better preconditions for an optimum selection of the hole geometry. For a minimization of

the hole diameter attention has to be paid to the choice of the pipe connections. A possible solution in the future can be the use of welded connections, which is already usual practice in cavern holes today. This results in a reduction of costs for the pipes and does not require more time for the installation of the pipes.

2.3. Drill pipe, BHA and bits

With regard to the construction and the material, a depth up to 5000 m does probably not create any greater problems in the use of the normal rotary drill string as well as the wireline drill string. Also, no problem is posed by the drill collar string in rotary drilling including the stabilizers, the jar and the shock absorber. As you know a reduction of the bit performance has to be taken into consideration in the use of roller cone bits with relatively small diameter. Here PDC-bits, especially the ballset bits, are a possible solution, however not in all cases. The use of natural diamond bits for drilling ranges without coring is not recommended, because then you have neither a core nor usable cuttings, which can be used for a row of researches. For the roller cone bits a DHM should be used in rotary drilling if possible in order to make use of its advantages. The great disadvantage in using the rotary drilling technique is the necessity to use a normal core barrel, which must be drawn after each cored interval, which unambiguously speaks in favour of use of the wireline drilling technique in scientific drilling. Also if a wireline drill string is used, technical solutions should be seriously checked which enable the round trip of a DHM together with the inner core barrel. Such a solution was proposed a long time ago by the ITE in Clausthal for the drilling of horizontal holes. In this connection a solution for a retractable system with fixed rotor and inner core barrel and a rotating stator, which drives the external core barrel, should also be checked. In this case it is possible to improve the core recovery in complicated ranges. Such solutions would especially save the relatively sensitive and expensive wireline drill string. Efficient impregnated diamond bits for this purposes are available today. Also, the question of a bit, which is interchangeable through the wireline drill string should be discussed in this connection again. The use of a wireline drill string also offers the possibility of a packer test with the drill string in the hole. The use of a fluid sampler through the wireline drill string is possible as well much time can be saved by the elimination of roundtrips.

When direction drilling is necessary for a correction of the hole deviation or to pass a fish, modern directional drilling technique can be used. Up to a depth of 5000 m the relatively expensive vertical drilling systems, which are used in the KTB-Hauptbohrung for the reduction of drag forces which have to be expected in a deep hole, are certainly not necessary. In contrast the use of the MWD and LWD technique is desirable

for the acquisition of data while drilling. Much remains to be desired with respect to the measuring data. In addition to the data for the hole direction this refers to the gamma measurement for the identification of the alternation of beds and a control of the drilling mud, for instance by measuring the conductivity for the direct identification of a medium influx in the hole for the purpose of determining the test ranges.

2.4. Drilling mud

However has had to do with drilling technology, knows the tasks of the drilling mud and that the properties of the drilling mud decisively affect the technical, economic and scientific result of a hole. In scientific holes, the influence of the drilling mud on the tests and geophysical data, for instance by its conductivity, is most important in addition to the drilling mud compatibility with the drilled rocks and its ability to secure the stability of the hole. When the drilling mud is selected a great variety of demands has to be taken into consideration, which can not be correctly fulfilled all points. This also becomes very clear in the study of the KTB-Reports. At the beginning of new scientific holes it is necessary to choose the best drilling mud, supported by many lab investigations, and to weigh many facts, with other words, there is a continuous need for development with respect to the drilling mud.

2.5. Rig selection and pipe handling

Among other things, the availability of powerful hydraulics and modern control equipment has made is possible to fulfil all wishes of the driller with respect to the drilling rig, as is demonstrated by the drilling rig for the KTB-Hauptbohrung. Not at each scientific hole is it possible to go this way, in particular not for a depth up to 5000 m. The question of the most important advancements can be answered as follows:

- drive:dc- motors supplied from the public main feed line or diesel-generator units
- top drive with hydraulic engines und rotary table
- pipe handling system with suitable tongs, which guarantee the best possible handling of the drill pipe, in particular of the wireline drill pipe
- an efficient mud cleaning equipment including centrifuges
- extensive and high-quality drilling process measurement equipment, for instance for the supply of data which can be sampled at the surface for the scientific analysis of the hole

This list can be continued, but I think the most important points were named.

3. Acquisition of information

The guarantee of the necessary acquisition of information in drilling is the central question in each scientific hole. For the acquisition of information above the ground and out of the hole, both in the drilling process and after drilling, we have at hand a great variety of equipments and methods. From the selection, which can very quickly can come close to time and financial boundaries, the result of a scientific hole will decisively depends. Information can be obtained out of holes by

- drilling process measurement including MWD and LWD
- winning of cores and cuttings
- geophysical measurements in the hole and
- tests including the sampling of gaseous and liquid samples.

3.1. Drilling process measurement, MWD and LWD

For the technical safety of a hole it is inevitable to have a certain standard with respect to the drilling process measurement equipment. When it is a scientific hole, the number of measuring data will considerably increase. The selection or the development of a transmitter which is working safely under the extreme conditions in the drilling technique often is the greatest problem. Desirable in scientific drilling is also the use of the MWD and LWD technique, especially for the acquisition of data which are important for the realization of the scientific goal of the hole. When using a wireline system and the MWD technique it is possible to think of a transmission of the data through a cable, which is also used for the drawing of the inner core barrel. With respect to the data, to be measured, there are many wishes. For instance, I think of gamma measurement and the measurement of the mud conductivity. In this connection, there is the question whether it makes sense if the stability of the hole is sufficient, to use underbalanced drilling in scientific holes, which would favour the winning of a influx profile, would improve the conditions for tests and, moreover, increases the drilling velocity.

3.2. Cores and cuttings

Even though today's possibilities of the data acquisition by geophysical measurement in many cases make it unnecessary to take cores and this is a way to save money, a continuous core is desirable in scientific drilling. At the core, many investigations can be performed, which are very difficult in situ or are not possible at all. The demand to win as much core as possible has of course effects on the choise of the drilling method and the drilling technique, and speaks unambiguously for the use of the wireline drilling technique. The taking of cores from the hole wall is, after all, only an emergency solution for the sections in which there was a core loss or in which there

was no core for other reasons. When no core is won, one should take care to have cuttings of a site suitable for investigations.

3.3. Geophysical measurement in the hole

The importance of geophysics for measurements in the hole in scientific drilling does not have to be explained in this place. In contrast discussion is needed concerning the various connections and dependences, especially in scientific drilling, between geophysics, the drilling technique and the group which scientifically evaluates the data. The drilling technique uses the measuring data of geophysics for technical decisions (for instance the measurement of the cement top, cement bond log and temperatures) and the geophysical measurement is used for planned tests for the identification of the test ranges.

3.4. Tests and sampling of liquid and gaseous samples up to 5000 m depth

Especially in scientific holes, tests and sampling of liquid and gaseous samples hold a key position. They are an absolute necessity in terms of the scientific goal and are used for the solution of many questions, for instance, for the analysis of the permeability or the permeability coefficient, the transmissibility or transmissivity, the reservoir pressure, the storage coefficient, the skin factor, the investigation of liquid and gaseous contents, and the investigation of the samples.

Tests need much time. Everything must be done to use the right tests in the right hole ranges. A long-term and preliminary planning of the tests and sampling is possible, but when drilling the hole, a quick and exact preparation of the tests and samplings must be guaranteed in dependence on the concrete situation. The need for a test or sampling will very often be spontaneous. The first task, which has to be solved is the identification and the fixing of the test and sampling ranges.

3.4.1. Decision to the test and sampling ranges

For the fixing of the test and sampling ranges we have at hand today many methods and equipments. Many questions have to be answered before a successful test or sampling is possible. In the drilling process, the drilling mud is an information carrier, and its gas contents and chemical composition can give first hints. For the identification of mud loss ranges and ranges with influx, the exact measurement of the volume difference at the wellhead should be guaranteed in scientific drilling. After the removal of the drill string it is possible to make a delimitation of the test ranges by mud logging

including temperature measurement. These results can cause an immediate sampling. Furthermore we have geophysical methods for the delimitation and/or fixing of the test and sampling ranges. Examples are the Formation Micro Scanner Tool (FMST) which is used together with the Stratigraphic High Resolution Dipmeter device (SHDT) and provides structural, sedimentary and textural information, the SP-Log for the delimitation of permeable ranges in sedimentary rocks, the Borehole Acoustic Televiwer (BHTV) which can identify oriented structural elements such as fissures and breakouts and also can notice the gross texture if necessary, and is therefore very interesting for the fixing of the setting ranges of the packers. Useful is also the Radioactive Tracer Ejector Tool (RTT) which can be used for the identification of influx and loss ranges. In cored hole ranges the analysis of the cores is necessary. The information on the possible test ranges must be completed by information on the geometrical conditions in the hole for the fixing of the setting ranges of the packers, and for indirect statements on the stability of the hole from which the possible depression in packer tests can be derived. True teamwork of all persons involved is needed to make the right decisions for the performed tests and sampling.

3.4.2. Possible tests in scientific drilling

The drill pipe test (DPT) with a length of the interval between 1.5 m and 60 m should be used immediately after drilling of the range to be tested. By lowering the counterpressure, the hydraulical properties of the layer can be determined by recording the pressure for a time up to 48 hours. If the lowering of the counterpressure is too high, problems with the stability of the hole are possible. When the permeability is low, the Pulse Injection Test with a short pressure charge can be used for a reduction of the test time.

An additional possibility for testing is given with the Hydraulic Test Tool (HTT) which corresponds to the drill pipe test. It but differs from the drill pipe test in the following points:

- it is used after reaching the final depth of the hole or before the casing is installed,
- the packers are placed hydraulically via the tubing and are loosened by lifting. The packers can be placed several times.
- the pressure and the temperature are measured below and above the packer elements, or below and above the individual packer element, and
- the measuring data are transferred to the surface.

The possible test variants are shown on the figure.

Another possibility for testing are hydraulical fill up tests (Slug Test or Constant Head Injection Test), which are connected

with temperature logs in order to obtain information on the absorbing capacity of the individual ranges.

Also, the Long-time Water Level Lowering Test, by the lowering of the pressure and the observation of the increasing of the water level, offers the possibility to determine the integral transmissivity of the test range, if the boundary conditions are known. For the testing of ranges with a low permeability a marked production test can also be used, in which by the admixture of a tracer it is possible to determine stream velocities and influx ranges. For a test at a small area directly at the wall of the hole with simultaneous sampling, the Repeat Formation Tester (RFT) can be used. For the investigation of the rock stress the Hydrofrac Test can be employed.

Even this short representation shows the variety of possibilities offered by hydraulic tests. The significance of these tests will mainly depend on the dispersal of the measuring data, the available time and the right evaluation of the boundary conditions.

3.4.3. Sampler and Sampling

For the sampling of fluids with solved gases there are two fundamental types of samplers, the influx sampler, which is used with one evacuated chamber, and the throughflow sampler in which the individual chambers are open and flowed through by a pump. Both samplers include the Sample in the depth under in situ conditions, thus fulfilling an important precondition. The throughflow sampler, however, in many cases leads to a contamination of the sample, because it is not possible to completely exchange the fluid, especially when the drilling mud in the hole has a high viscosity. Therefore in scientific holes the influx sampler should be preferred when it is necessary to have an uncontaminated sample. A precondition for successful sampling is, as for the tests, the previous reliable identification of the sampling depth.

4. Important problems and possible further developments in drilling, testing and sampling in scientific holes

In the transparency, the main points and possibilities of development are named which should be discussed and are possible starting points for R & D.

In each case a true teamwork will be necessary in every regard in order to make the drilling of scientific holes more efficient and more successful. Again, I would like to quote the words of Prof. Betz, which has characterized the necessary team-work of all discipline as a "Symbiosis in the best sense of the word".

Literaturverzeichnis

1. KTB Report 87-3; Grundlagenforschung und Bohrlochgeophysik (Bericht 2)
Redaktion Hänel, R.
Abschnitt 5 "Notwendigkeit einer Vorbohrung" S. 71 - 78
Abschnitte 7.1 - 7.3 "Definitionen"; "Standardmeßverfahren"
u. "Hydraulische Teste" S. 91 - 135
2. KTB Report 89-3; Beiträge zum 2. KTB-Kolloquium, Gießen, 15. bis 17.3.1989
Brunn, V. et al. - Poster - ("Druckentwicklung in einer Formation bei der Simulation hydraulischer Bohrlochtests")
S. 462
3. KTB Report 90-1; Grundlagenforschung und Bohrlochgeophysik (Bericht 8) Bohrlochmessungen in der KTB-Oberpfalz VB
Intervall 3009,7 - 4000,1 m
Abschnitt 7 :
Kück, J., Bochum "Hydraulische Teste"
S. 169 - 180
4. KTB Report 90-2; Tiefbohrung KTB Oberpfalz VB, Ergebnisse der geowissenschaftlichen Bohrbearbeitung im KTB Feldlabor - Bericht 8 Teufenbereich von 3500 - 4000,1 m (E.T.)
Heinschild, H.-J., Stroh, A., Tapfer, M. und Wittenbecher, M.
Abschnitt C.4.3 "Fluid Sampler" S. C22 - C25
Abschnitt C.5.3 "Fluid Sampler" S. C39 - C40
5. KTB Report 90-4; Beiträge zum 3. KTB-Kolloquium, Gießen, 28.2. bis 2.3. 1990
Betz, D., Hannover "Geowissenschaft und Technik im KTB - eine kompetente Symbiose- S. 14 - 22
Wittenbecher, M. und Heinschild H.-J. "Detektion und chemische Charakterisierung von Fluiden im Rahmen kontinuierlicher Spülungsanalytik" S. 156 - 158
Zimmermann, G. und Burkhardt, M. "Abschätzung der Porosität kristalliner Gesteine aus Bohrlochlogs mit Hilfe multivariater Verfahren, S. 159 - 170
Draxler, J. et al. "Klufiterkennung durch Bohrlochmessungen, Gasanalyse und Kernaufnahme", S. 192 - 216
Reifenstahl, F. und Stober, I. "Hydraulische Auswertung des Absenk- und Injektionstests sowie des Fluid-Logging vom Mai 1989", S. 257 - 263
Rischmüller, H. "KTB-Kolloquium in Gießen - Einführung Technik" S. 378 - 383
Sperber, A., Chur, C., Engeser, B., Rischmüller, H. und Wohlgenuth, L. "Das technische Konzept der KTB-Hauptbohrung" , S. 384 - 408
Engeser, B., Tran Viet, T., Hoffers, B. und Kessels, W. "Die Bedeutung der Bohrspülung für die KTB-Hauptbohrung, insbesondere im Hinblick auf die Wechselwirkung mit dem Gebirge" , S. 409 - 451

Heinschild, H.-J. und Wittenbecher, M. - Poster - "Fluide in der KTB-Vorbohrung", S. 458

Kessels, W., Zoth, G. und Kück, J. - Poster - "Absenk- und Injektionstest in der KTB-VB Oberpfalz", S. 474

Reifenstahl, F. und Stober, I. - Poster - "Hydraulische Auswertung des Absenk-Injektionstests und des Fluid-Logging vom Mai 1989", S. 576

6. KTB Report 90-5; Grundlagenforschung und Bohrlochgeophysik (Bericht 9) "Hydraulische Untersuchungen in der Bohrung"
Kessels, W. "Zielsetzung und Durchführung hydraulischer Untersuchungen in der Bohrung KTB-Oberpfalz VB", S.3 - 17
Engeser, B. und Kessels, W. "Technische Durchführung hydraulischer Tests in der KTB-Oberpfalz VB", S. 21 - 81
Zoth, G. "Untertage-Probenahmesysteme zur Gewinnung von in situ-Fluidproben", S. 85 - 120
Heinisch, M. "Probenahme übertage und in situ", S.123 - 135
Kessels, W. und Pusch, G. "Auswahl hydraulischer Testzonen in der KTB Oberpfalz VB anhand von Bohrlochmessungen", S. 139 - 164
Jobmann, M. und Reifenstahl, F. "Vergleich der Ergebnisse von Absenk- und Injektionstests im Hinblick auf Klüfterkennung", S. 167 - 169
Enacescu, C., Miede, R. und Pusch, G. "Auswertung geohydraulischer Tests in der Bohrphase der KTB-Vorbohrung", S. 173 - 232
Kessels, W., Zoth, G. und Kück, J. "Erste Ergebnisse eines Absenkungs- und Injektionstestes in der KTB Oberpfalz VB", S. 235 - 283
Reifenstahl, F. und Stober, I. "Hydraulische Auswertung des Absenk-/Injektionstestes und des Leitfähigkeits-Fluid-Loggings". S. 287 - 315
Jobmann, M. "Thermischer Injektionstest", S. 319 - 329
Baumgärtner, J. und Rummel, F. "In situ Permeability Measurements in the KTB Pilot Hole VB Using a Wireline-Operated Hydraulic Fracturing Straddle Packer Assembly" S. 333 - 340
Kessels, W. und Zinner, G. "Einschätzung der beim Pumpstest in der KTB Oberpfalz VB zu erwartenden Zuflußmengen anhand der Ergebnisse des Absenktests", S. 343 - 356
Ostrowski, L. "Hydraulisches Testprogramm KTB-VB Ergebnisse und Felddauswertungen", S. 359 - 435
7. KTB-Report 90-6a; Grundlagenforschung und Bohrlochgeophysik (Bericht 10) Langzeitmeß- und Testprogramm in der KTB-Oberpfalz VB
Reifenstahl, F. und Stober, I. "Absenk-/Injektionstests und Leitfähigkeits- Fluid-Logging in der KTB Oberpfalz VB", S. 285 - 313
8. KTB Report 91-3; Tiefbohrung KTB-Oberpfalz HB - Ergebnisse der geowissenschaftlichen Bohrungsbearbeitung im KTB-Feldlabor, Bericht 1 zur KTB-Hauptbohrung - Teufenbereich von 0 - 1720 m

- Figgemeier, Ch. et al. Abschnitt C - Geochemie
Abschnitt C3 "Gasanalytik" , S. C13 - C28
Heinisch, M. "Das automatische Probenahmesystem für die
Hauptbohrung des KTB" , S. I1 - I3
9. KTB Report 92-1; Grundlagenforschung und Bohrlochgeophysik
(Bericht 13) Bohrlochmessungen in der KTB-Oberpfalz HB
-Intervall 1720,0 - 4512,0 m -
Kessels, W., Kück, J. und Zoth, G. "Hydraulische
Untersuchungen in der Bohrung KTB-Oberpfalz HB bis 5000 m",
S. 169 - 197
 10. KTB Report 92-2; KTB Hauptbohrung - Results of Geoscientific
Investigation in the KTB Field Laboratory 0 - 6000 m
Figgemeier, Ch. et al. C. Geochemistry/Mineralogy
Abschnitt C.2 "Gas Analysis" S. C12 - C25
 11. KTB Report 93-1; Basic Research and Borehole Geophysics
(Report 14) Borehole logging in the KTB-Oberpfalz HB
-Interval 4512,0 - 6018.0 m -
Bram, K. "Logging and Testing in the superdeep borehole
KTB-Oberpfalz HB: Concept and first Results of the depth
interval 0 - 6018 m", S. 3 - 21
Engeser, B., Huenges, E., Kessels, W., Kück, J. und
Wohlgemuth, L. "The 6000 m hydrofrac test in the KTB main
borehole design, implementation and preliminary results",
S. 301 - 336
Kessels, W. und Kück, J. "Hydraulic communication in
crystalline rocks between the two boreholes of the
Continental Deep Drilling Programme in Germany", S.337 - 365
 12. Rasmus, J. C. und Gray Stephens, D. M. R. "Real-Time Pore -
Pressure Evaluation from MWD/LWD Measurements and Drilling-
Derived Formation Strength"
SPE Drilling Engineering, December 1991, S. 264 - 272
 13. Bryant, T. M. et al. "Gas-Influx Detection with MWD
Technology"
SPE Drilling Engineering, December 1991, S. 273 - 278
 14. Davidson, A. R. et al. " Successful High-Temperature/High-
Pressure Well Testing from a Semisubmersible Drilling Rig"
SPE Drilling & Completion, March 1993, S. 7 - 13
 15. Kittitep Fuenkajorn und Jaak J. K. Daemen "Drilling-Induced
Fractures in Borehole Walls"
JPT (1992) 2, S. 210 - 216
 16. Ramey Jr., H. J. "Advances in Practical Well-Test Analysis"
JPT (1992) 6, S. 650 - 659
 17. Haberman, J. P. et al. "Downhole Fluid-Loss Measurements
from Drilling Fluid and Cement Slurries"
JPT (1992) 8, S 872 - 879

18. Kamal, M. M. "Expected Developments in Transient Testing"
JPT (1991) 8, S. 898 - 903 und S. 995 - 997
19. Hermanrud, Ch. et al. "Determination of Virgin Rock
Temperature from Drillstem Tests"
JPT (1991) 9, S. 1126 - 1131
20. Yildiz, T. und Langlinais, J. "A Reservoir Model for
Wireline Formation Testing"
JPT (1990) 9, S. 1192 - 1198
21. Ehlig-Economides et al. " A Modern Approach to Reservoir
Testing"
JPT (1990) 12, S. 1554 - 1563
22. Dietzel, H.-J. " Zur Entwicklung der Frac-Technik seit
1960" (Development of Fracturing Techniques since 1960)
Erdöl Erdgas Kohle 106 (1990) 11, S. 434 - 438
23. Betz, D. "Neue Maßstäbe durch wissenschaftliche
Hochtechnologie" (New Dimensions in Earth Sciences with
High Technology)
Erdöl Erdgas Kohle 10 (1990) 12, S. 471 - 477
24. Sperber, A. "Das Verrohrungskonzept für die KTB-
Hauptbohrung" (The Casing Concept for the KTB Ultradeep
Well)
Erdöl Erdgas Kohle 106 (1990) 12, S. 483 - 485
25. Ellins, M. und Tran Viet, T. "Spülungskonzept und Mud
Logging-System für die KTB-Hauptbohrung" (Drilling Fluid
Concept and Data Aquisition System for the KTB Ultradeep
Well)
Erdöl Erdgas Kohle 106 (1990) 12, S. 491 - 495
26. Engeser, B. "Die Kernbohrstrategie für die KTB Hauptbohrung"
(The Coring Strategy for the KTB Ultradeep Well)
Erdöl Erdgas Kohle 106 (1990) 12, S. 496 - 500
27. Wohlgemuth, L. und Chur, C. "Die KTB Bohranlage"
(The Drilling Rig for the KTB Ultradeep Well)
Erdöl Erdgas Kohle 106 (1990) 12, S. 501 - 503
28. Chur, C. "Die Bohrtechnik im Dienste der Geowissenschaften"
Erdöl Erdgas Kohle 107 (1991) 1, S. 2 - 6
29. Rischmüller, H. "Beitrag der Bohrprojekte der
Lithosphärenforschung zur Entwicklung der Bohrtechnik für
große Tiefen, dargestellt am Beispiel des KTB"
(Ultra Deep Drilling in Lithosphere Research Enhances R&D in
Drilling Technology, as Demonstrated by the German
Continental Deep Drilling Program (KTB))
Erdöl Erdgas Kohle 107 (1991) 2, S. 51 - 58

30. Kraus, W. und Geisler J. "Erfahrungen beim Abteufen übertiefer Bohrungen" (Experience in Drilling Superdeep Holes)
Erdöl Erdgas Kohle 107 (1991) 2, S. 67 - 72
31. Chur, C. et al. "KTB-Hauptbohrung - Stand des Projektes im Mai 1993"
Erdöl Erdgas Kohle 109 (1993) 5, S. 209 - 215
32. "World record for depth and speed"
Drilling News 3rd Quarter 1985
33. "Record breaking and record making drilling"
Drilling News 3rd Quarter 1986

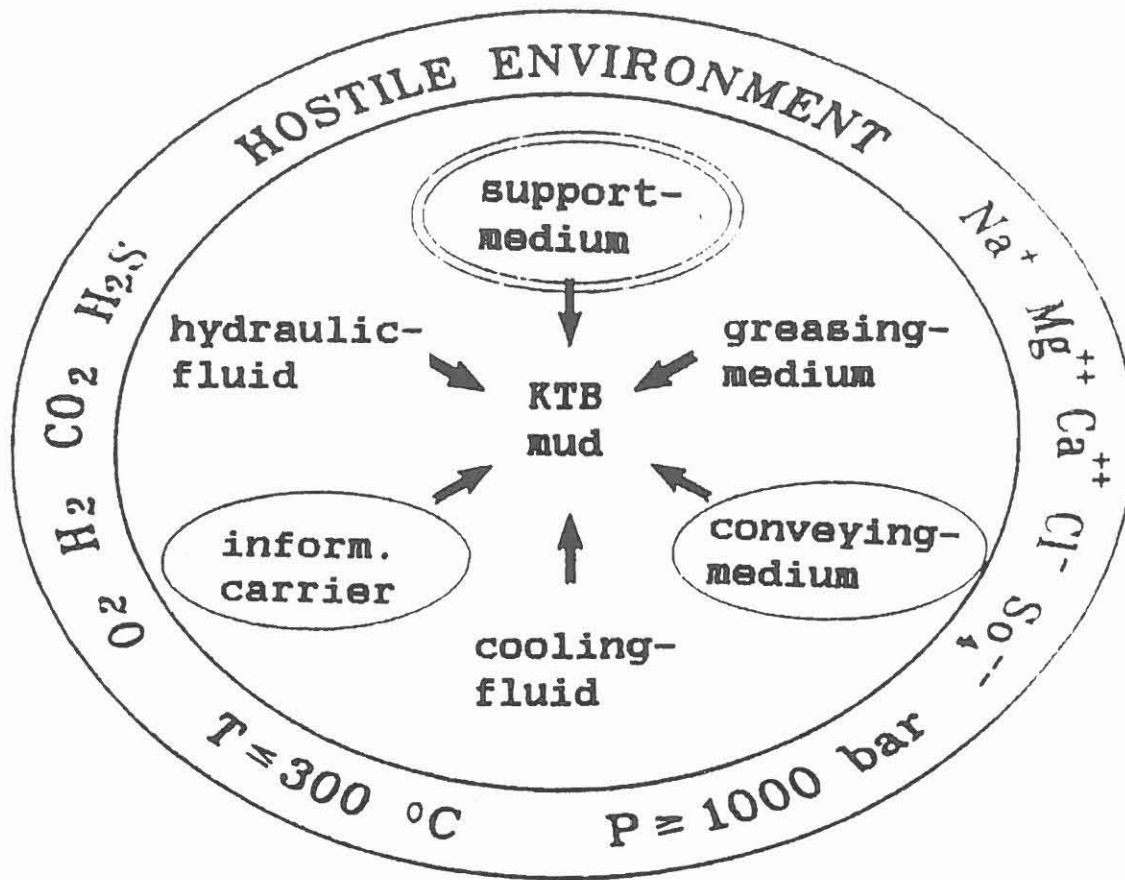

Demands to the KTB-drilling-mud

/5 - S. 411/

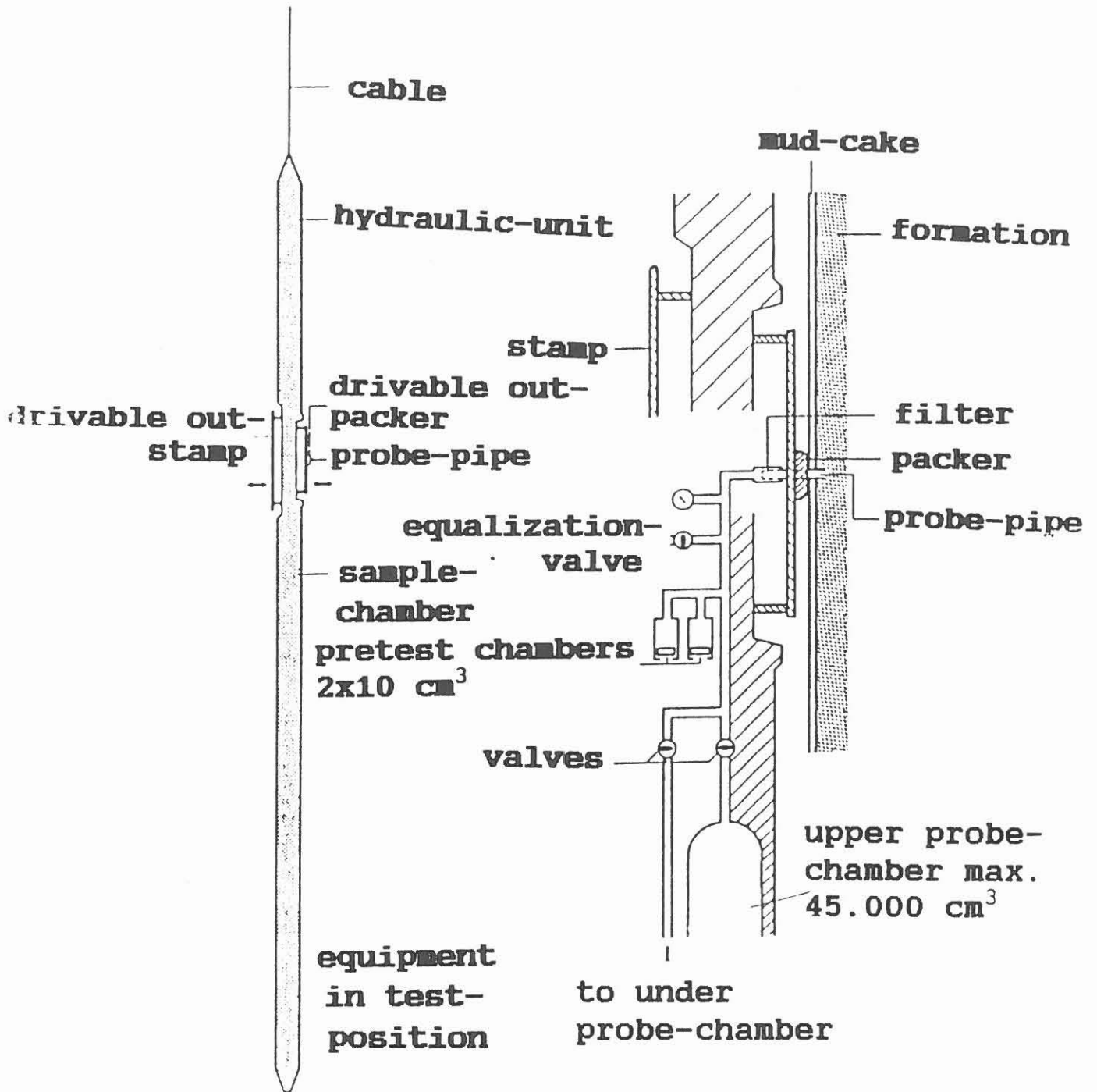

Repeat Formation Tester (RFT) /1 - S. 126/

PRESSURE VESSEL

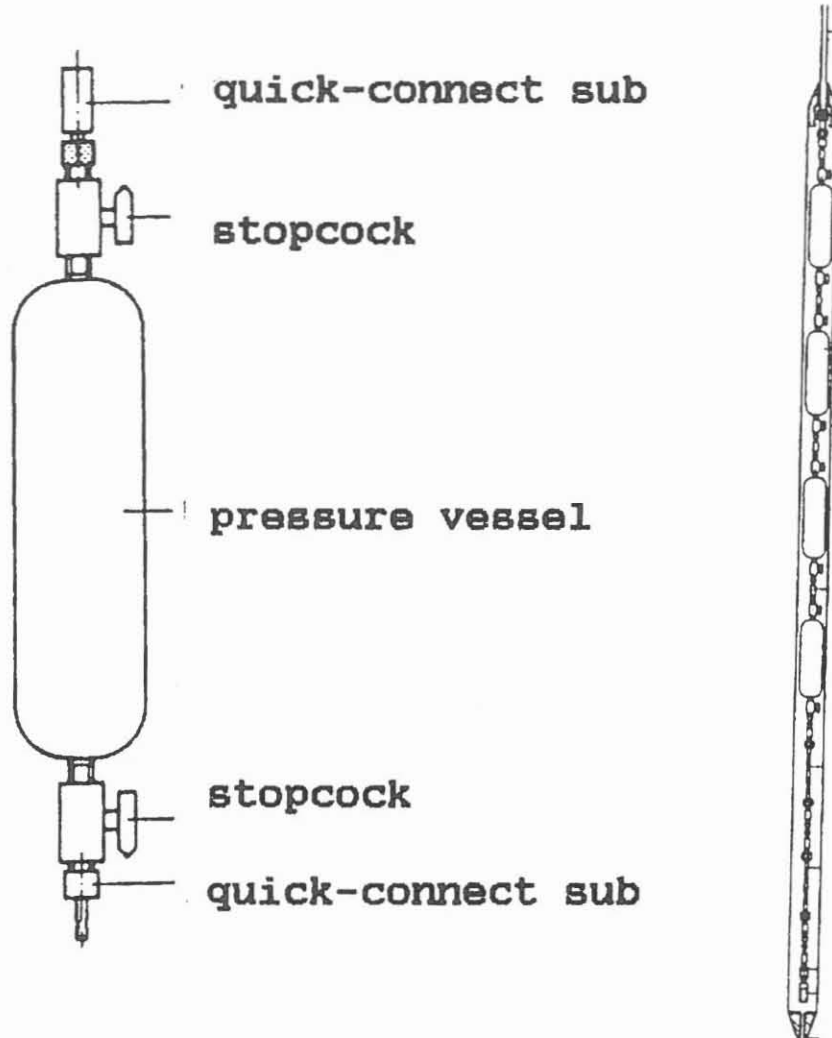

Technical Dates

- Several pressure vessels
- Chamber volume 500 cm³
- Chamber coated with teflon
- Mechanical closing of the valves by N₂
- Pressure vessel = Transport vessel

Throughflow Sampler /1 - S. 89/

A - Slug-Withdrawal-Test B - Slug-Injection-Test

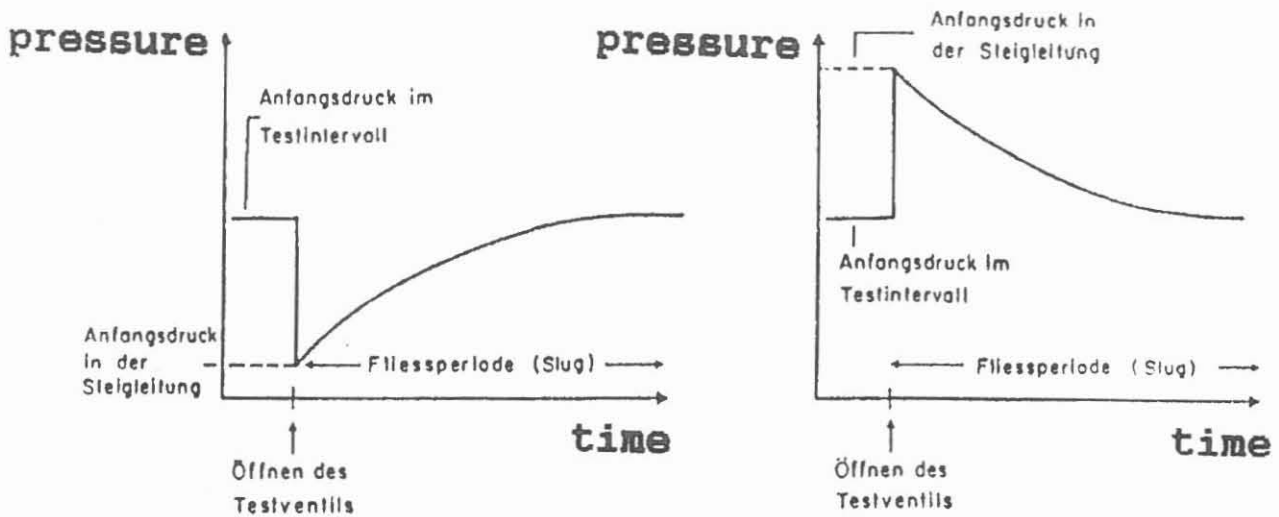

C - Pulse-Withdrawal-Test D - Pulse-Injection-Test

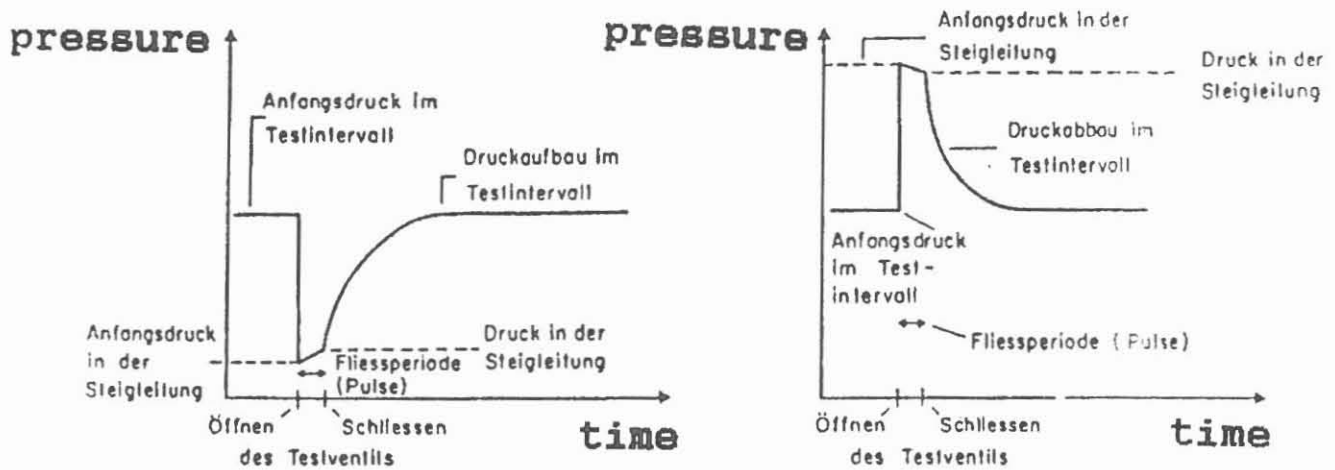

Possibilities for Testing /1 - S. 134/

- A - Usable for permeable areas with great volumes**
- B - How A**
- C - Usable for areas with a small permeability**
- D - How C**

Drill Stem Test (DST)

/1 - S. 130/

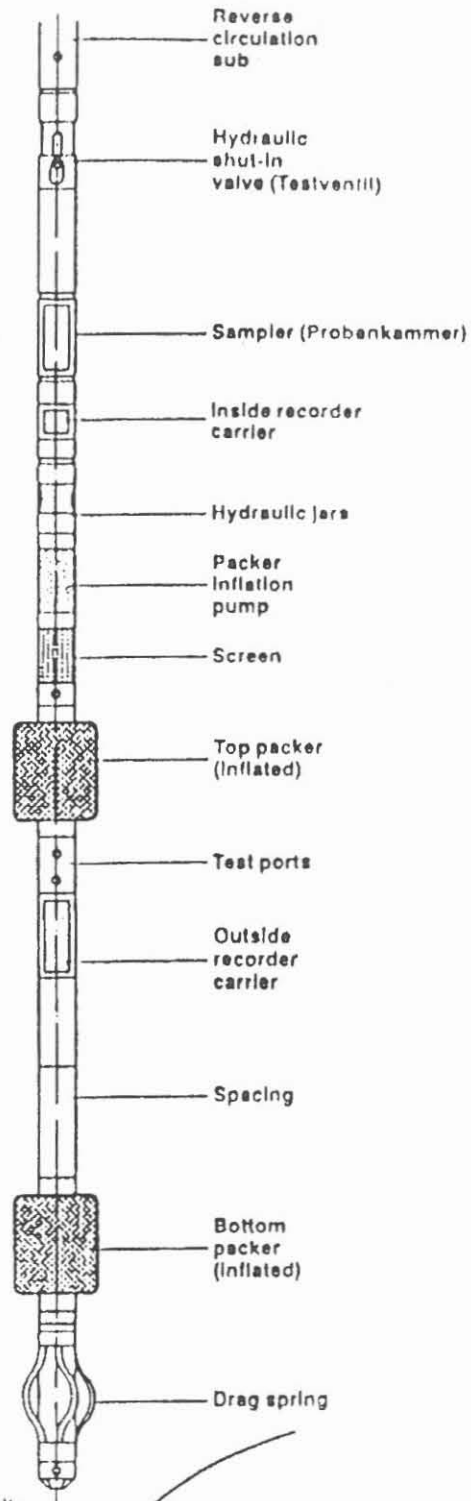

pressure

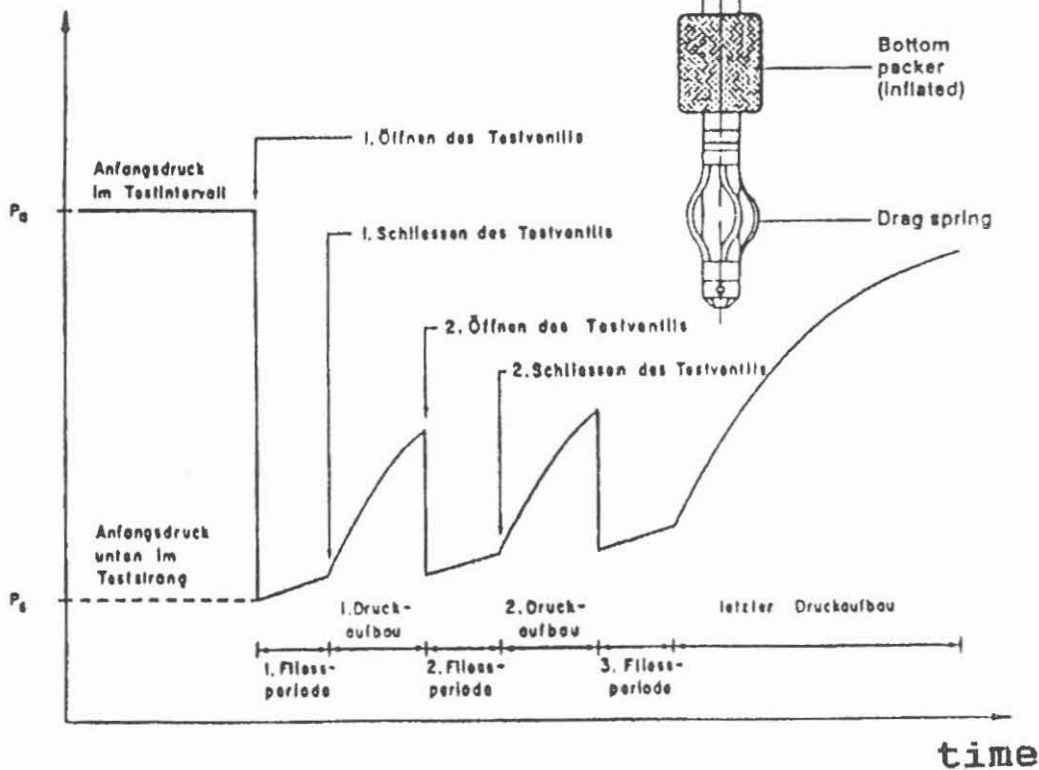

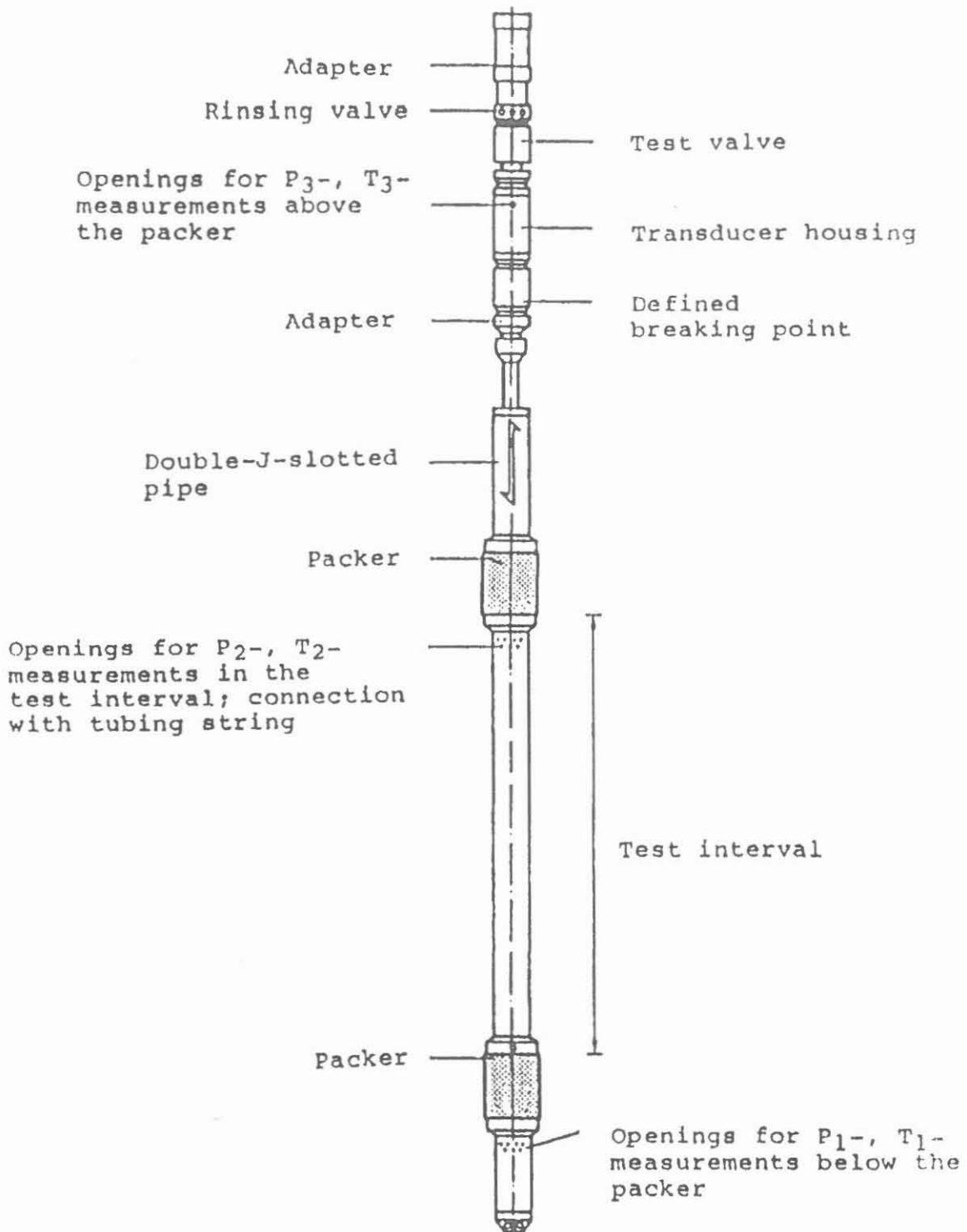

Hydraulik Test Tool (HTT) /1 - Abb. 7.25/

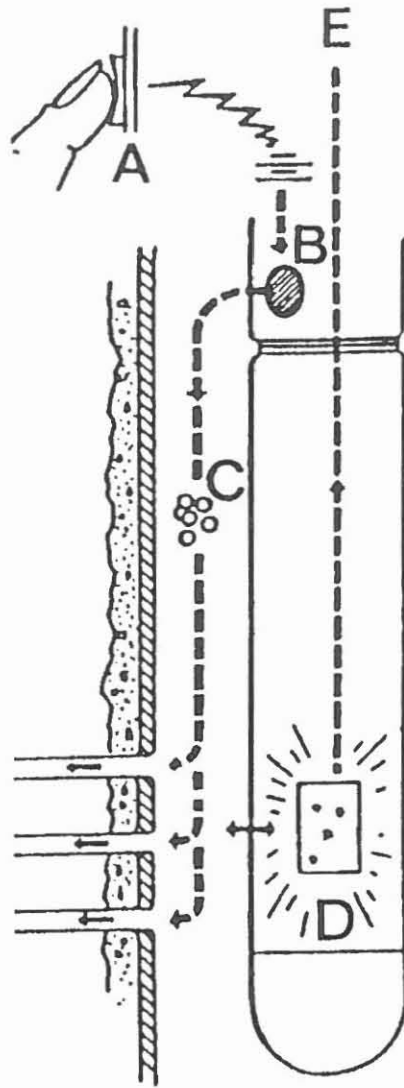

Radioactive Tracer Tool (RTT) /1 - Abb. 7.21/

- A - TRACER RELEASE**
- B - TRACER CONTAINER**
- C - TRACER**
- D - GAMMA-RAY COUNTER**
- E - TO REGISTRATION DEVICE**

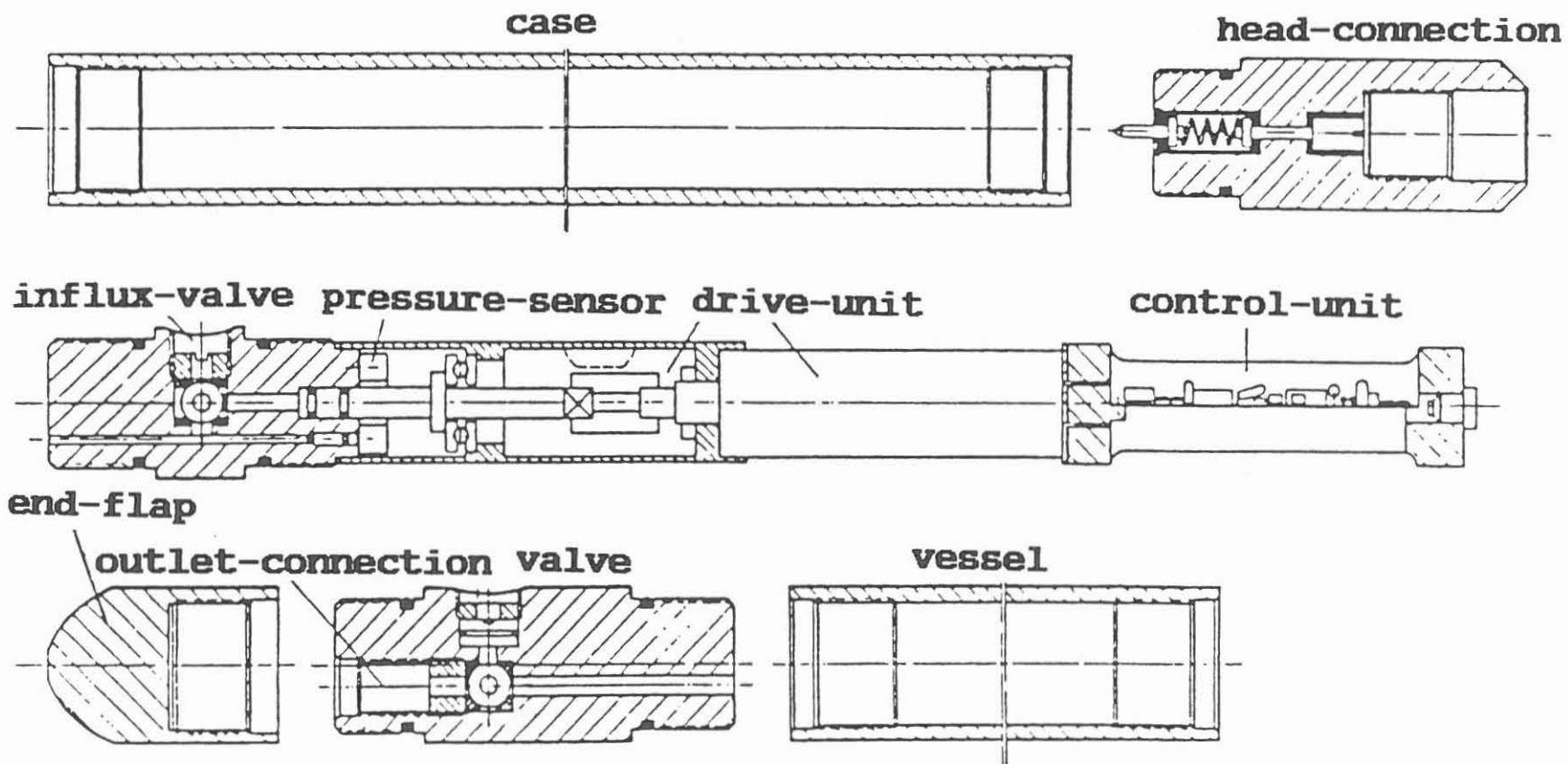

Influx Sampler /1 - S. 88/

Important problems and possible further developments

- to choose and develop a special drilling technique and technology for scientific drilling
- to define the borders of the wireline drilling technique and technology for scientific drilling
- to develop geophysical equipment for smaller diameters
- development of new drilling muds for scientific drilling
- use of high-frequency-welded pipes
- use of welded pipe connections
- to develop PDC-bits for harder rocks
- to develop DHM coring systems for wireline drilling
- to develop bits interchangeable through wireline drillstring
- to perform packer tests through the wireline drill string
- use fluid samplers through the wireline drill string
- use of the MWD and LWD technique in scientific drilling with the wireline drilling technique
- drilling underbalanced when the stability of the hole is sufficient
- use of equipment for measuring the volume difference at the wellhead

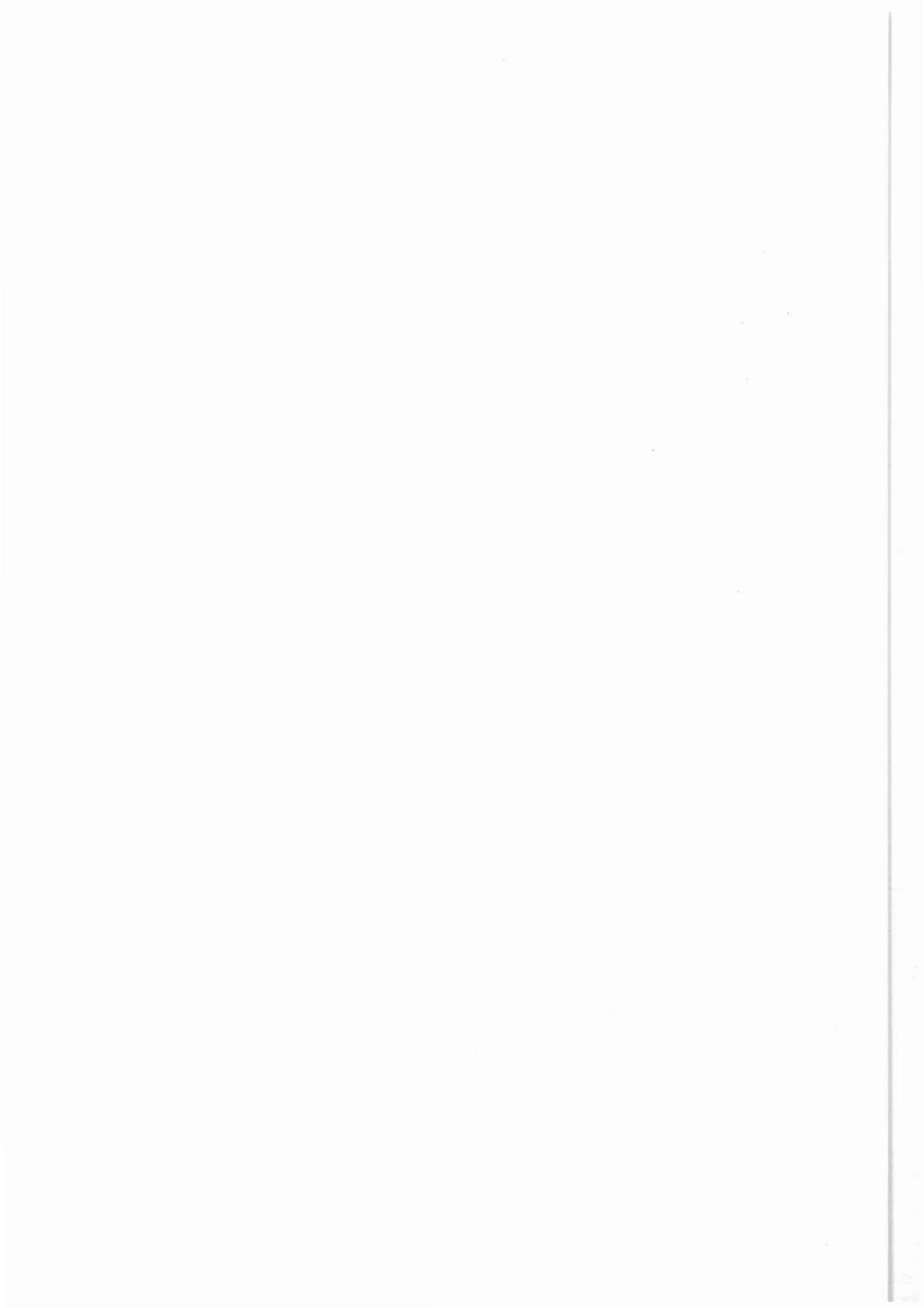

Slim hole and horizontal drilling
– Potential for geoscientific research –

R. Jürgens

Baker Hughes INTEQ GmbH
Christensenstraße 1
29221 Celle / Germany

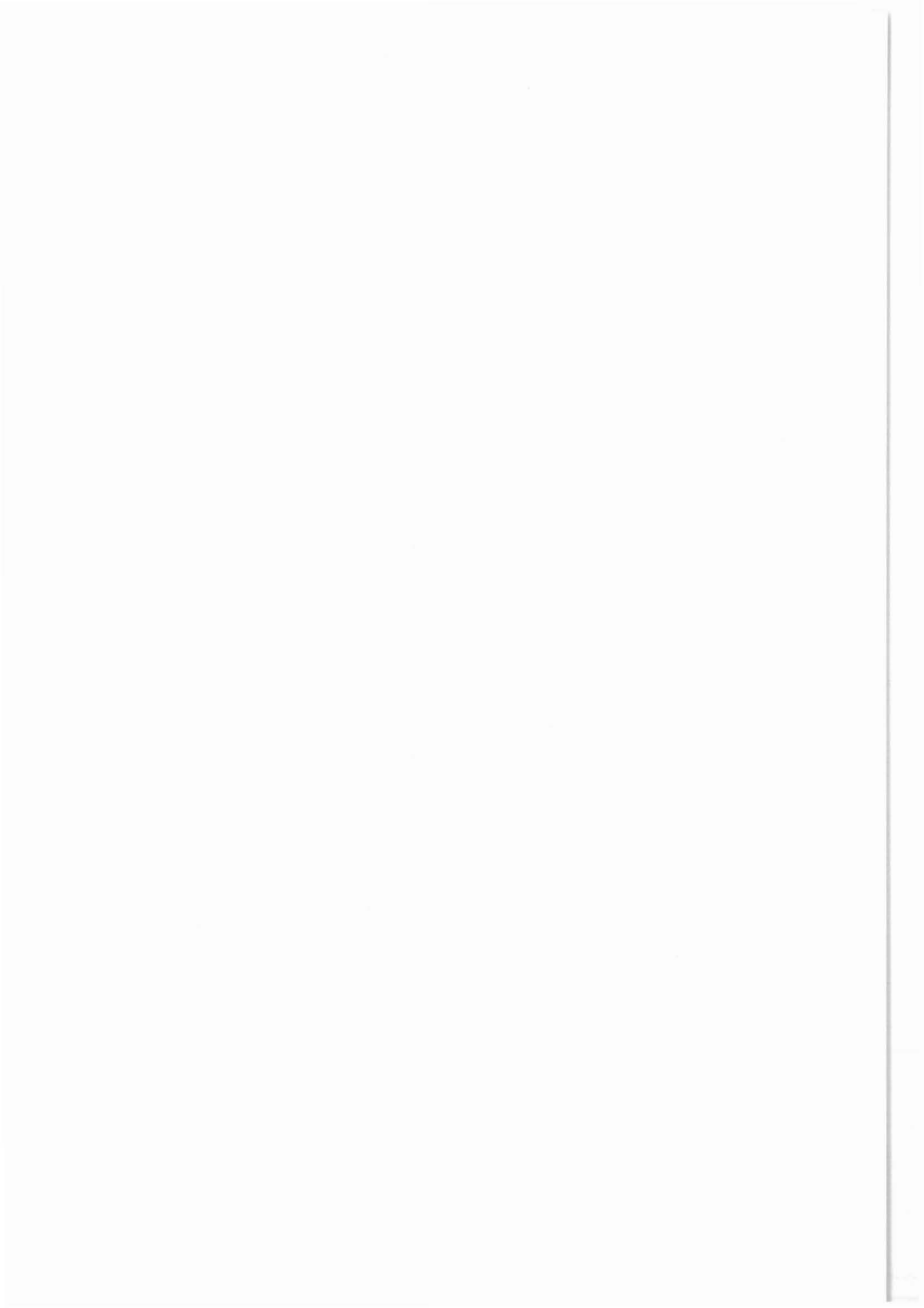

SLIM HOLE AND HORIZONTAL DRILLING - Potential for Geoscientific Research -

Potsdam, August 31, 1993

by Dr.-Ing. Rainer Jürgens

1. Current Drilling Tools Development Trends

Oilfield drilling product innovation has seen considerable acceleration during the last thirty years, especially in comparison to the period before the second world war.

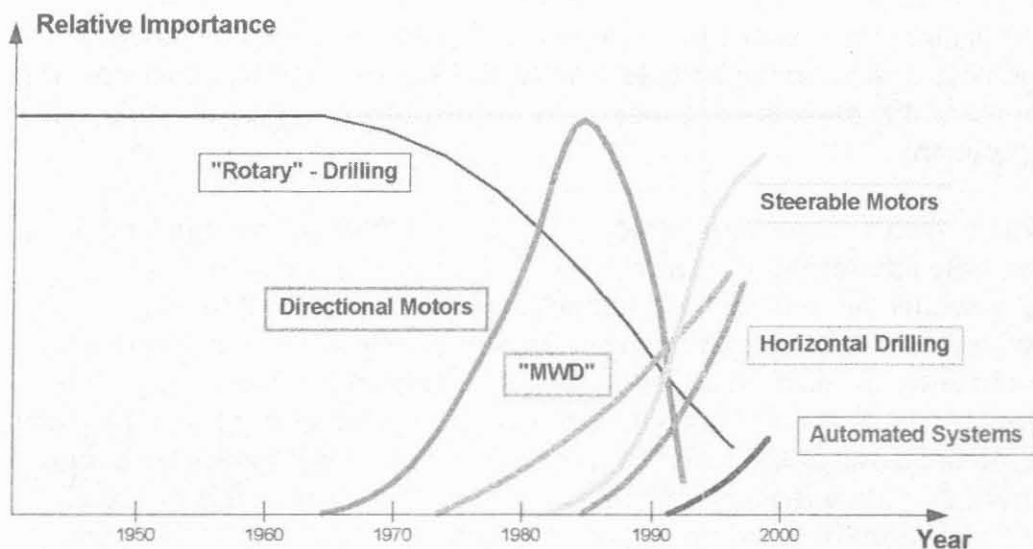

Basically until the middle of the 1960's drilling practices in the oilfield had not changed so much as compared to the situation at the turn of the century. Major technological achievements have occurred in the drilling industry not much earlier than 1970. Technological changes really accelerated during the 70's, to a certain extent as a reaction on the shortage of petroleum on the world market.

A major change has been the application of downhole motors, both positive displacement and turbine, for directional drilling application. This coincides with the relatively decreasing importance of driving the drill bit with the rotary table.

A continuously increasing importance of directionally controlled drilling operation work has been seen in the 1980's. Major reasons have been, among others, the desire to recover hydrocarbon resources under consideration of the least environmental impact, and the need to utilize existing formation pay zones to the maximum possible extent. In view of strong economical constraints marginal oil and gas fields can only be drained if targets are reached in a very precise and cost-effective manner.

In parallel downhole electronic measuring instruments have been made available for directional purposes. Such systems basically consist of a direction sensing part, electronics, electric power supply, and signal transmission unit. The standard state-of-the-art "Measurement While Drilling" (MWD) system usually has a mud pulse data transmission device for communication to the surface. A wireline may be used alternatively, for example, in a steering tool.

As a characteristic drawback of directional drilling systems, the downhole tool can only be used for drilling the curvature in the hole. After finishing this curved section the tool has to be pulled for replacement with a standard straight hole drilling bottomhole assembly. Drilling then usually proceeds with a rotary assembly or, in some cases, with a stabilized straight downhole motor configuration.

Steerable systems now offer a major drilling cost savings through longer bottom hole intervals of the same BHA. The steerable motor allows to selectively drill the curvature as well as the straight path with the same equipment, without pulling out of hole intermediately. This drilling method allows to steer the well path along an intentionally selected course. In the oriented mode, the motor housing with bent part is not rotated with the rotary table, but adjusted to the required direction. When straight ahead drilling is required, the rotary table is rotated at a moderate speed. In this mode a slightly oversized hole will be drilled. Of course an MWD has to be used together with the steerable system as well.

Very much in parallel the development of horizontal drilling systems has been seen since the middle of the 1980's. These drilling practices allow to recover the hydrocarbon pay zones to a much higher extent than was possible with conventional techniques. Some details in this area will be presented later on.

Slim hole drilling focuses on the optimization of drilling economics by reducing the hole diameter to the smallest possible extent. This applies especially to exploration wells. Major development and drilling efforts were undertaken from the late 80's onward.

A further reduction of drilling exploration costs is expected to occur by means of a higher level of automation in drilling systems for directional control. Following the development sequence from whipstock rotary drilling, bent

housing motor drilling, to steerable motor application, the next logical step would mean to mechanize the alteration between rotary and steering mode through automated systems. Automatic, basically downhole located, steering control is an enhanced method to drill complex curvatures of hole with less error and reduced efforts compared to the existing steerable motor technology. In addition, through the anticipated instantaneous reaction to any disturbances from formation inconsistencies, a smoother curvature will be obtained, thus leading to less torque and drag in the hole.

• Navigation Drilling	1986
• Steerable Medium Radius Systems	1989
• High Torque Downhole Motors	1992
• Slim Hole Drilling Technology	1993
• Fully Steerable Med. Radius Motors (30°/100 ft)	1993
• MWD Motor Integration	1994
• Coiled Tubing Drilling System	1994
• Automated Drilling System	1995

Among the most important driving forces for development efforts in the drilling service industry, the following might be mentioned:

- Economics during the hydrocarbons's recovery process
- Environmental protection impacts
- Marginal field/extended depth recovery needs
- Geoscientific drilling demands

Geoscientific drilling has seen a widespread application over the last decades, starting with the "Mohole Project" in the late Sixties, and presently seeing a culmination point in the KTB. Future international projects of this kind will very probably follow in the near future.

Geoscientific drilling on the one hand requires the development of drilling equipment for very specific and challenging drilling parameters. On the other hand these new developments will, either directly, or through a spin-off effect, have a tremendous influence on the oilfield drilling technology in general. Quite a number of examples may be given for such a mutual relationship.

2. Horizontal Drilling

The overall rig count in western countries (US excluded) shows a clear decline in activity since the year of 1991.

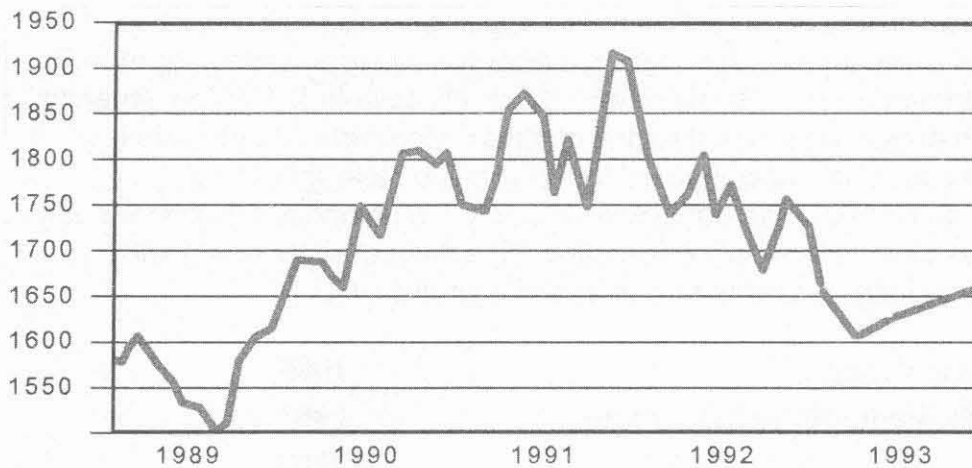

Despite this general bad economic situation in the oil industry, horizontal drilling has experienced a tremendous progress both in technological and economical ways. With the growing demand to more extensively produce the hydrocarbons from the existing pay layers, horizontal or drainhole drilling tools have become the one major driving factor in the industry. This is clearly witnessed by the number of horizontal wells drilled over the years.

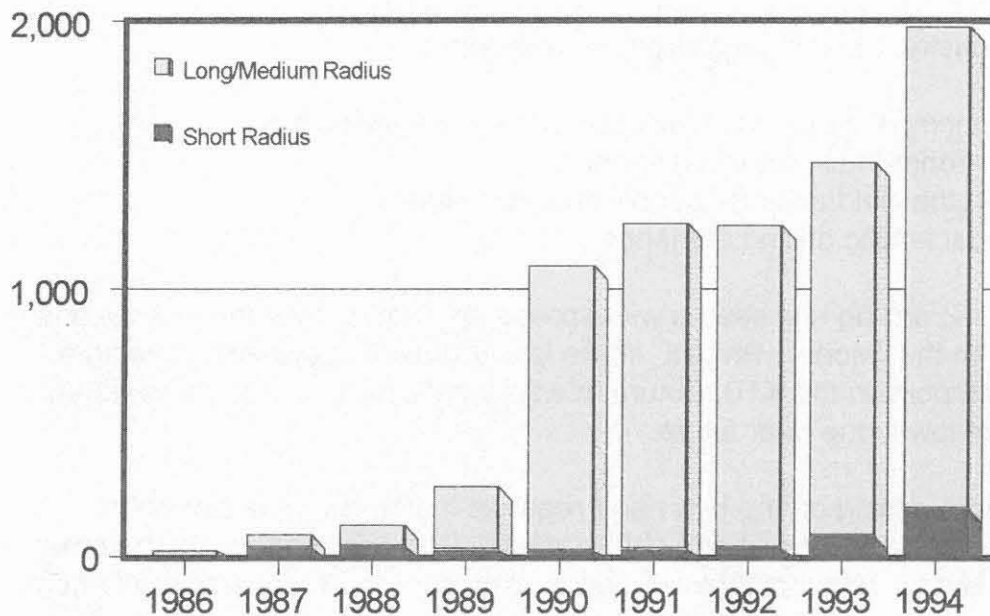

A variety of different tools and systems were developed over the years. They are made to offer a good flexibility and adequate function for any drilling radius required. As can be seen from the above graph, the relative importance of short radius project is steadily increasing over the years. This is basically due to the fact that short radius drilling has turned out to be a major tool to re-entry existing fields or wells, which do not longer produce from their current well situation.

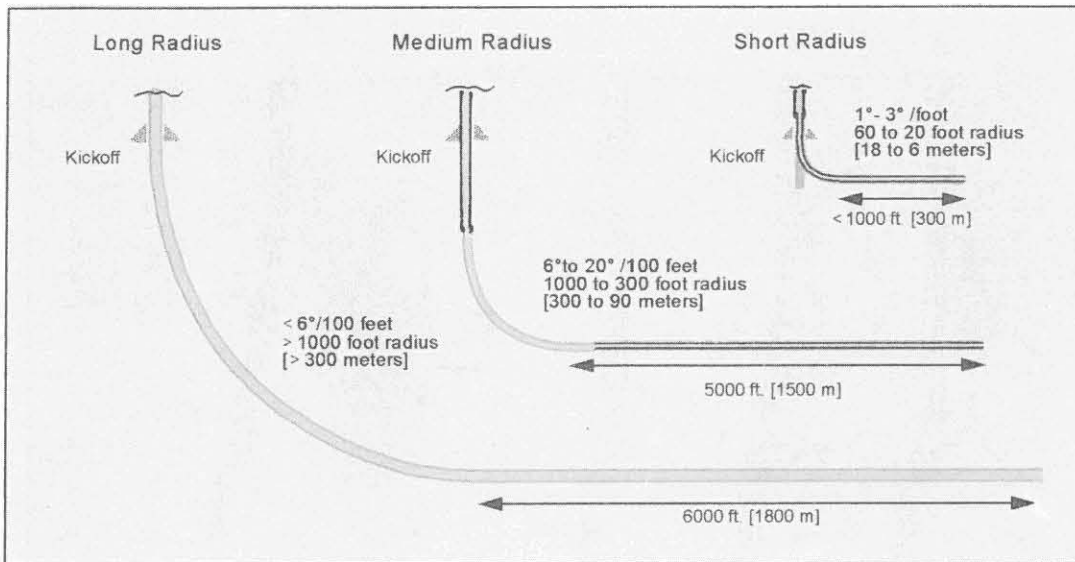

Short radius wells have traditionally, since the 1930's, been drilled by means of a special rotary technique. State-of-the-art technology however applies very progressive downhole motor technology for this purpose.

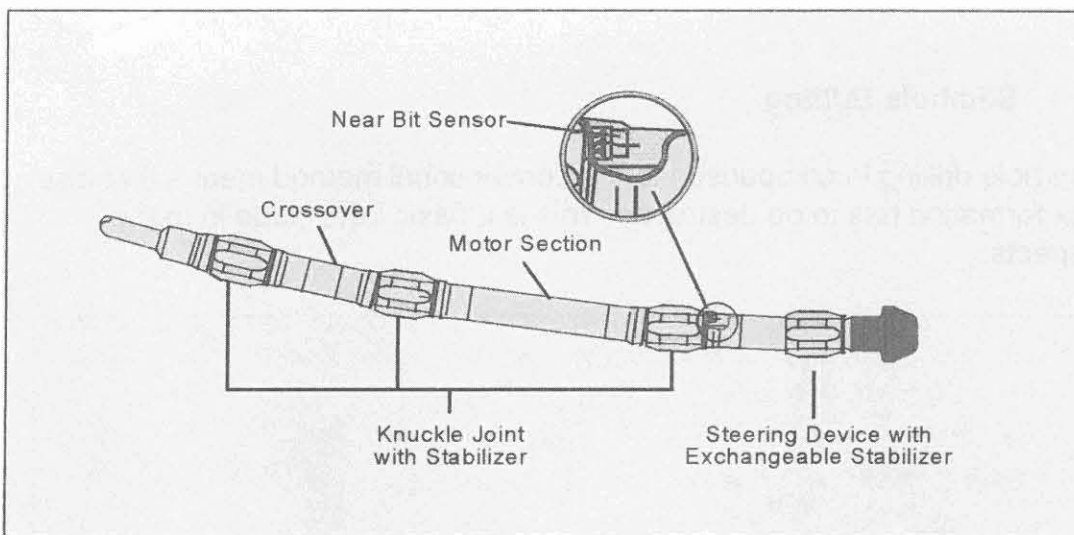

With the articulated motor technology as shown above, a minimum radius of 12 m can be drilled. The major advantage of connecting stiff and short motor sections rather than build the motor out of flexible members is a higher degree of curvature build accuracy.

For drilling the long and medium radius horizontal wells, a variety of directional drilling motors can be used, some of them also being fully steerable. The state-of-the-art "AKO" (adjustable kick-off sub) design allows to adjust the motor build rate at the rig site.

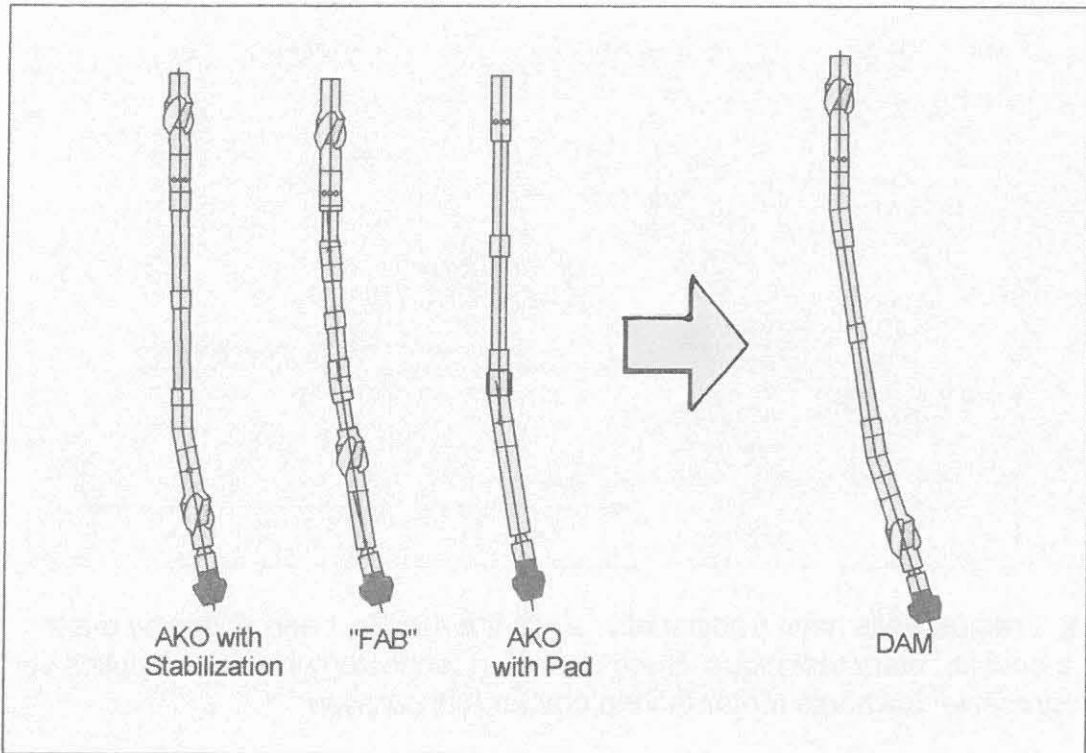

3. Slimhole Drilling

Slim hole drilling in comparison to the conventional method means that less rock formation has to be destroyed. This is a basic advantage in many respects.

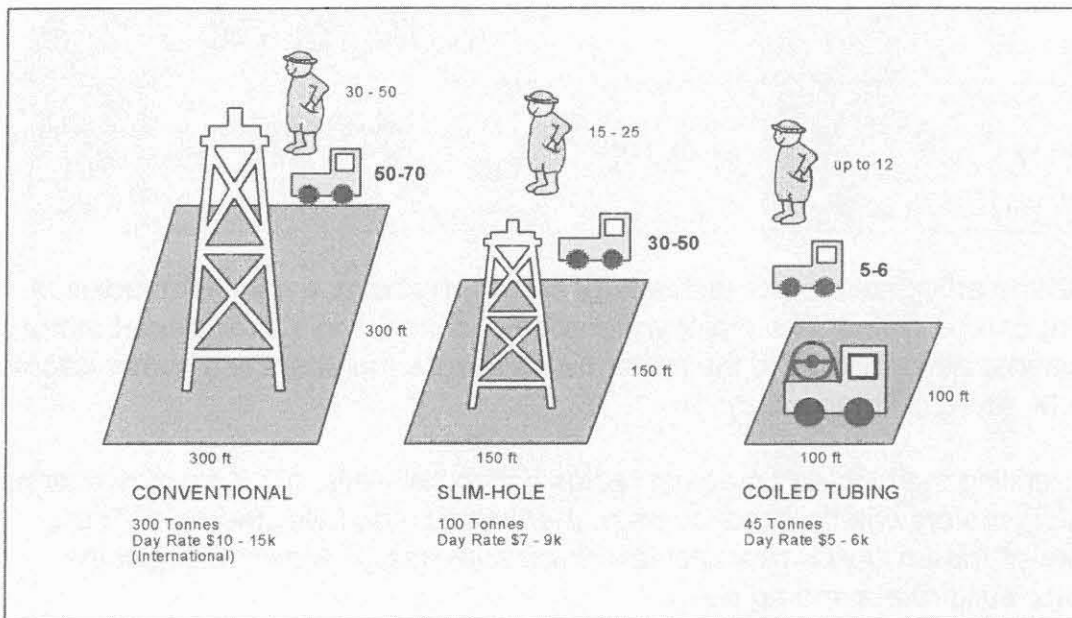

A number of different kinds of slim hole drilling methods has been developed and tested during the recent past. Slim hole drilling has been made available for HT/HP exploration wells of 5,000 m depth and more, both onshore and from offshore floating rigs. Also the production of oil from shallow wells out of slim hole wells turns out to be economic under certain circumstances. Slim hole coring methods have been developed to recover core samples in a most economic way. Applying the continuous wireline coring process with thin-kerf diamond core bits allows to maximize core recovery and ROP at the same time.

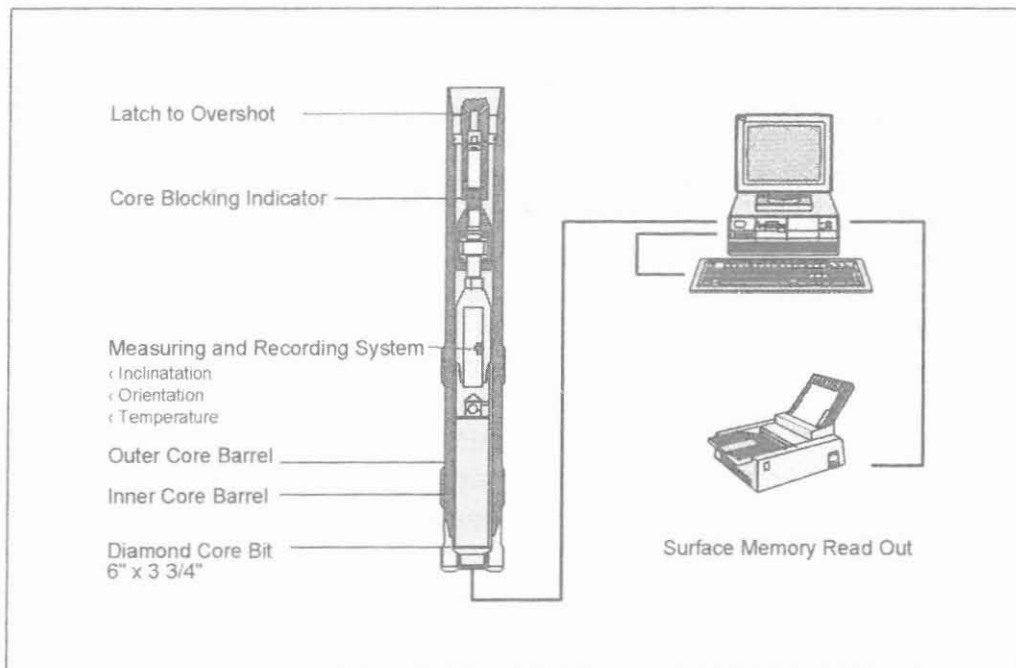

Coiled tubing in general combines the advantages of a slim borehole and a continuous drill string. The coiled tubing technology for drilling of exploratory wells currently sees a lot of interest in the industry and heavy development efforts correspondingly.

Obviously one major characteristic of the coiled tubing application is the requirement to use a directional downhole motor if the well path has to be steered. Therefore in the most recent past a lot of efforts were focused on the introduction of downhole orienting devices, which allow to adjust the orientation of the motor bent by hydraulic or electric method. Since the coiled tubing offers a straightforward way of implementing a wireline connection, data as well as electric power supply between surface and downhole can be achieved rather easily.

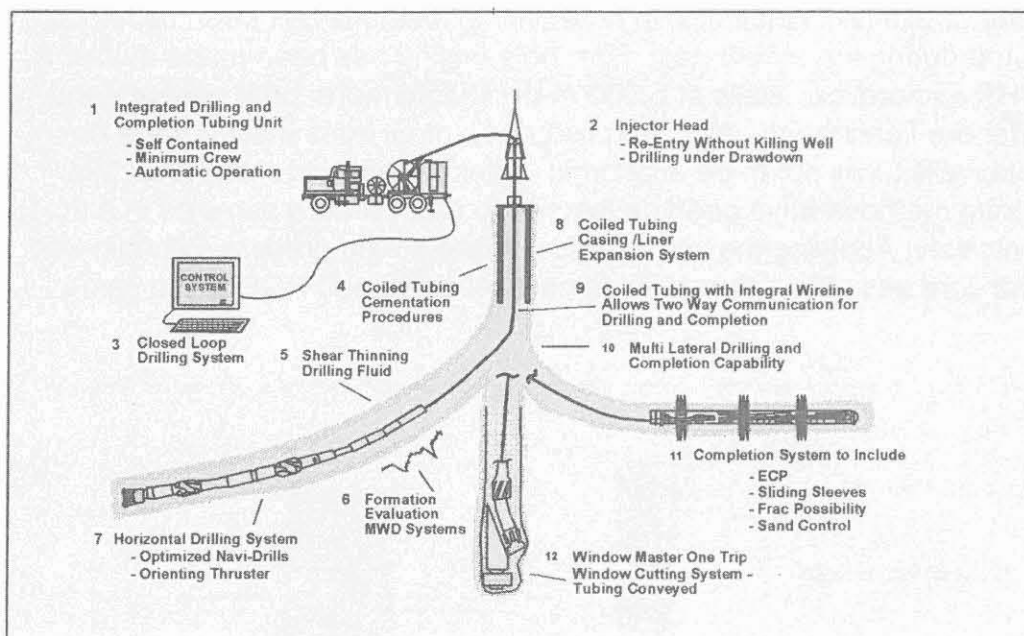

Coiled Tubing technology can be used with a full line of MWD instruments for directional and formation evaluation purposes. Several options to exit an existing well bore casing have been investigated already and put into praxis as well. Horizontal drilling has been introduced to coiled tubing drilling as well. In addition multi-lateral drilling as well as completion has been identified as another major area of application for this emerging technology.

4. Application Potential for Geoscientific Research

Slim hole drilling has already seen quite a few applications in different scientific projects, like the Cajon Pass, KTB Pilot Hole, etc. While spending less energy, boreholes can be drilled, or continuously cored, to considerable depths.

Horizontal drilling originally has it's basic application for the purpose of hydrocarbon's recovery through optimum drainage of the more or less horizontal pay zones. However, the motor steering technology being developed here has already had a dramatic influence on well steering in general. Every scientific borehole needs a controlled directional course, in order to minimize technical and economical risks.

In addition, for certain geological conditions, a slim hole horizontal drilling combination technology might offer good opportunities to achieve the scientific requirements. If, for example, an ultra-deep vertical well is drilled, intermediate side track drilling or coring out of the main well with such an equipment would allow to penetrate certain critical formation zones aside the vertical hole.

**UTB: Rig layout and rig operation for ultradeep
scientific drilling**

F. Young et al.

UTB ULTRATIEF Bohrgesellschaft mbH
Deilmannstraße 1
48455 Bad Bentheim / Germany

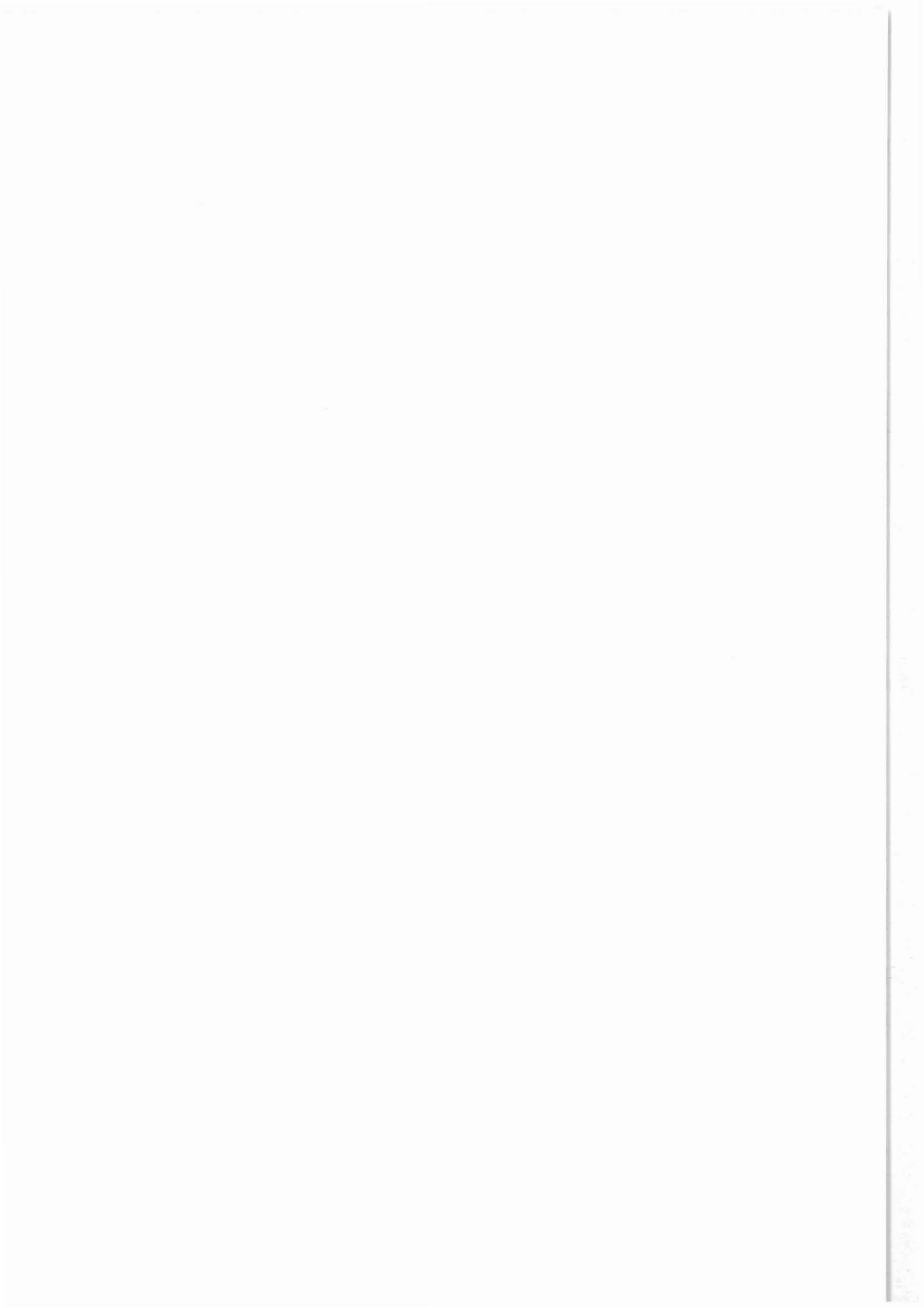

UTB: Rig Layout and Rig Operation for Ultradeep Scientific Drilling

H. Hohoff, Dr. Kerk, Dr. Young

UTB: Rig Layout and Rig Operation for Ultradeep Scientific Drilling

Content

- 1 UTB ULTRATIEF Bohrgesellschaft mbH - The Company
- 2 UTB 1 - The Drilling Rig
- 3 KTB - The Drilling Operations
- 4 References

UTB: Rig Layout and Rig Operation for Ultradeep Scientific Drilling

1 UTB ULTRATIEF Bohrgesellschaft mbH - The Company

For the purpose of engineering, constructing and operating the rig performing the scientific drilling of the ultradeep well of the German Continental Deep Drilling Project (KTB) the company UTB ULTRATIEF Bohrgesellschaft was founded by three major German drilling contractors in early 1988.

The founding companies are

- Deutsche Tiefbohr AG, DEUTAG
- Deutsche Schachtbau und Tiefbohr AG, DST
- Internationale Tiefbohr AG, ITAG.

After a restructuration of the drilling activities of PREUSSAG AG, of which DEUTAG and DST were subsidiaries, DEUTAG took over 85% of the UTB shares, ITAG holds the remaining 15%. This is reflected in the composition of UTB's supervisory board, consisting of two DEUTAG representatives and one ITAG representative. All administrative functions are reporting to a managing director from DEE, Deilmann Erdöl Erdgas GmbH (former DST), all operational functions to a managing director from DEUTAG. Furthermore ITAG provides a managing director.

On location three DEUTAG toolpushers are responsible for the operation of the rig. Five shifts are working on a three weeks on / two weeks off schedule. Each shift consists of driller, assistant driller, derrickman, two roughnecks and one roustabout. Mechanics and electricians keep the rig in good operational condition.

2 UTB 1 - The Drilling Rig

The geoscientific research programme KTB, to drill a well into the earth's crust to a bottom hole temperature of 300 °C, is not only a challenge in terms of science but also of techniques.

With accomplishing the tasks of designing, engineering, constructing and operating the rig, always observing narrow financial limits, UTB has made a decisive step towards the fully mechanised drilling rig. The innovations incorporated in the UTB 1 drilling rig already in 1990 with their high degree of mechanisation have shown how reasonable it is to get away from „isolated islands of mechanisation“ solutions and to act in terms of an integrated solution.

The key item of this integrated solution is the stationary pipehandling system. It consists of

- Drawworks
- Block-Retracting-System
- Iron Roughneck
- Dual Elevator Handling System
- Pipehandler
- Pipe Boom
- Pipe Conveyor / Hydraulic Tong
- Control Panel.

The location of these components is indicated in fig. 2 and fig. 3.

All these components are designed to operate in combination. It is evident that such a combined function is possible only by use of programmable logic control.

UTB: Rig Layout and Rig Operation for Ultradeep Scientific Drilling

The three key factors lead to the decision to build the complex pipehandling system are:

- The rig can be considered as stationary. High mobility during rig moves is not recommended.
- Roundtrips are very time consuming at depths of 10.000m or more. A large number of roundtrips was anticipated due to the scientific drilling programme.
- Safety of the operation could be significantly improved by using highest and latest technical standards.

Drawworks

The high performance requirements to drill large depths and the considerable number of roundtrips lead to the decision to develop a remote-controlled gear driven drawworks with three DC motor drive (2.200 kW input total).

Further design criteria are:

- Use of 40 m drillpipe stands
- Hookload capacity of 8.000 kN
- Line speed up to 20 m/s
- Four breaking systems
- Low noise level
- System failure diagnostic
- Supervising via TV cameras

Block-Retracting-System

The retractable block dolly was installed on guide rails suitable to adapt a topdrive system. The retracted block is allowed to start travelling down while a stand is still in the centerline of the well.

On the other hand the extension and retraction motion is used to transfer the elevator links from elevator to spider and vice versa operating with the the dual elevator handling system.

Iron Roughneck

The iron roughneck is designed for breaking (max 163.000 Nm) and making up (max. 136.000 Nm) connections not only in the center of the well but also in moushole position. The iron roughneck moves on rails into direction of the borehole center and finds the tooljoint position with ist sensors. After making up or breaking the connection it moves back to the parking position.

Dual Elevator Handling System

Two elevators, operated by remote control and functioning both as elevator and spider during roundtrips, support the mechanisation effect of the pipehandling system. During tripping the operation of the dual elevator system and the retractor system are mutually dependent.

The fact that the load of the drillstring on the rotary table is carried by the elevator shoulder instead of the slips acting on the drillpipe represents a considerable wear- and cost-reducing factor.

Pipehandler

The pipehandler is built as a stationary unit in order to keep the number of of steps of operation as low as possible.

UTB: Rig Layout and Rig Operation for Ultradeep Scientific Drilling

The semi-automated system is part of the derrick and is placed in the center of the setback area. It consists of two sections of a rotating column with a total height of 53 m which is equipped with hydraulically operated grippers.

The main pipehandler of a length of 37 m has a max. reach of 5 m at a lifting capacity of 50 kN. Its max. capacity of 150 kN is available at a reach of 3 m.

An auxiliary pipehandler is installed as back up unit on top of the main pipehandler to allow continuous operation during maintenance of the main unit.

Pipe Boom

The bottom frame of the pipe boom unit is inserted into the ground. It is levelled with the pipe rack. The gripper of the pipe boom takes a pipe from the pipe rack and moves it in a radius of 90° to the drillfloor in a vertical identified position.

Pipe Conveyor / Hydraulic Tong

The pipe conveyor has a vertical travel of the elevator of approx. 46 m. The manually controlled conveyor takes the pipe from the pipe boom by an elevator and lifts it into a position that allows the next pipe to be brought in by the pipe boom. Lowering the upper pipe allows to make up the connection with the hydraulic tong.

After making up an entire stand the stand is taken over by the pipehandler and moved into its position in the star fingerboard.

These operations can be performed while drilling.

Control Panel.

The driller's cabin is an ergonomic control station, offering two seats for driller and assistant driller forming a safe working environment. It is the center of operation and control of the entire drilling and pipehandling. This includes drawworks, rotary table, mud pumps, pipehandling system and the auxiliary drives.

Further informations on the rig are summarised in fig. 4, Technical Highlights of the UTB-Rig, and fig.5, UTB-1 Technical Specifications.

3 KTB - The Drilling Operations

Operational Highlights

Drilling of the KTB ultradeep well commenced on October 6th, 1990.

In the early phase the drawworks failed twice and needed repair in January and May 1991. Operation had to be shut down for some days.

In March 1992 the World's first frequency controlled AC-rotary drive came into operation on the UTB 1 rig.

The Dual Elevator Handling System was tested first in May 1992. It was installed for operation in November the same year. In November 1992 U-160 drillpipe came in operation as well. Unfortunately this string failed in February 1993.

The first drilling line of 5.000 m length was changed in June 1993 after a service of 690.977 ton kilometers.

On September 12th, 1994 two years of accident free operation on the rig could be celebrated.

Eighteen days later, September 30th, 1994 the well reached 9.043 m and was the fourth deepest well worldwide from thereon.

On October 12th, 1994 the drilling phase of the KTB ultradeep well was finished at a depth of 9.101 m. The final borehole diameter was 6 1/2".

UTB: Rig Layout and Rig Operation for Ultradeep Scientific Drilling

Accident Statistics

During the entire drilling operations four lost time accidents occurred on the rig. In 1990 a roughneck's foot was hit by a dropped tool on the pipe rack. In 1991 a roughneck slipped on iced stairs and a roughneck's thumb was squashed between tong jaws. While cleaning the mud ditch a roughneck slipped in same in 1992. Neither 1993 nor 1994 lost time injuries occurred.

The LTI frequency rate dropped from 43,2 in 1990 continuously down to 0 in 1993 and 1994. This is a result of DEUTAG's improved safety system, which was also used on UTB 1 as well as the long time steady operation of the rig on the same location.

Reasons for the high LTI frequency rate in 1990 are the facts that the shifts were put together from employees of three different companies and that the rig was new and unique for all of them.

Operating Time of UTB-Equipment

Drilling the KTB ultradeep well was quite a task for all associate equipment. The auxiliary systems of the drawworks were operating 82% of the duration of the drilling phase, i.e. more than 3 years operation time.

493 roundtrips were performed in 13.362 h (1,5 years).

Mudpumps I and II were in use for about two years and three months during the four years period.

The operating time of the rigs main components are summarized in fig. 8.

Time Breakdown of the KTB Ultradeep Well

In total operation of the drilling phase of the KTB ultradeep well took 35.232 h.

The most significant amounts of time were used for tripping (23,1%), drilling (22,9%) and redrilling (17,8%) (see fig. 9).

Triptime was expected to be higher than drilling time due to the scientific approach of the well. Redrilling was performed to keep the well vertical and to pass by fishes after plugging back.

For a comparison of the KTB ultradeep well to deep gaswells drilled in northern Germany to depths of max. 5.000 m redrilling was excluded.

The drilling related time ends up between approx. 60% (Gaswell 2) and 63% (KTB) of the total time spent.

The scientific time varies from 8,9% (Gaswell 2) to 11,4% (KTB).

The repair time of the UTB rig (2,6%) is average of these three wells. It has to be considered that the rig was new constructed for the purpose of drilling the KTB ultradeep well and shows a high degree of mechanisation which might lead to increased repairs.

Overall the time breakdown of all three wells look more or less similar (figures 10 and 11).

4 References

Wehling, B., Steckhan, H.

The Automated Drilling System

Offshore Northern Seas Conference, Stavanger August 1992

UTB ULTRATIEF Bohrgesellschaft mbH

Fig. 1

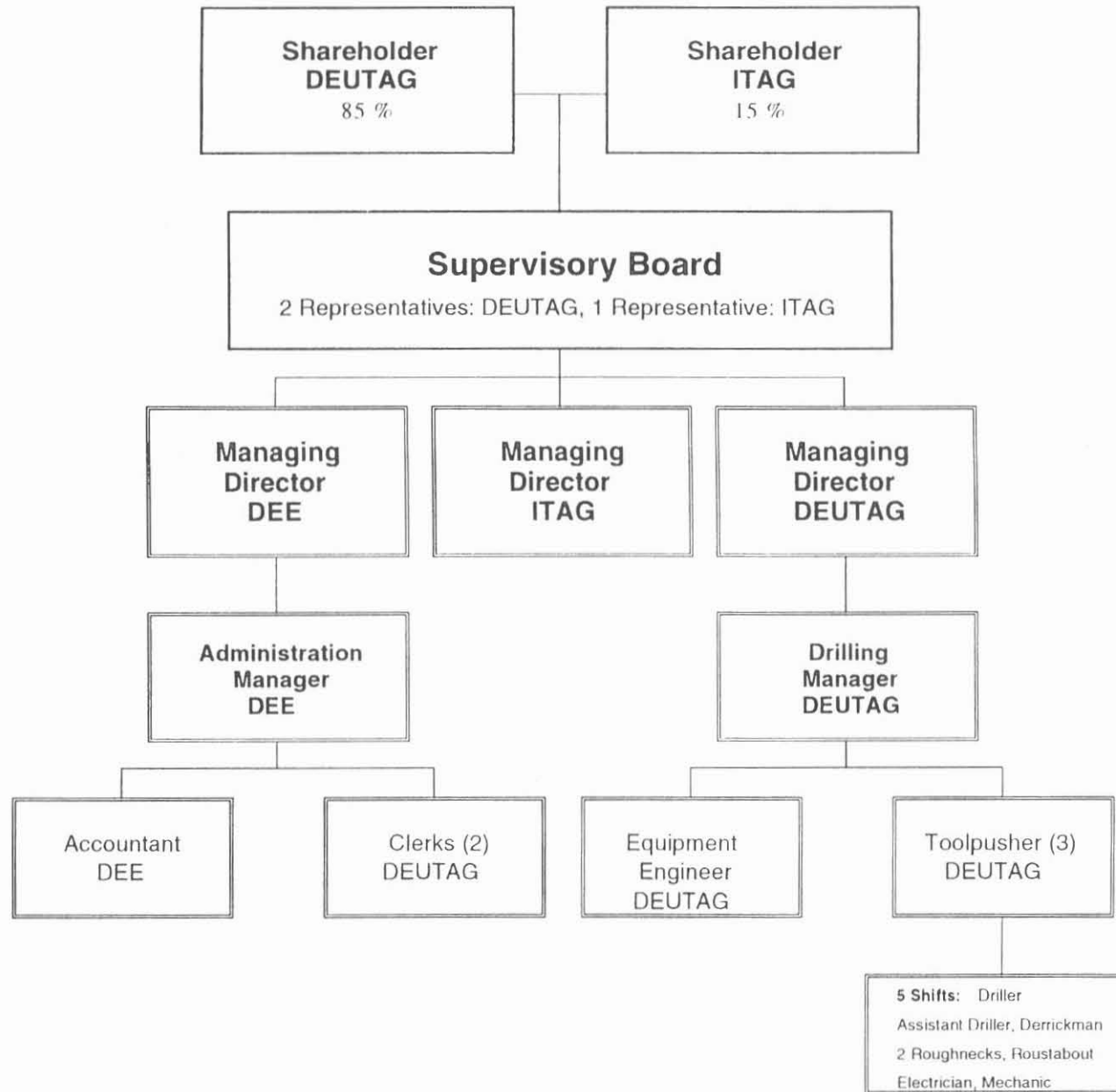

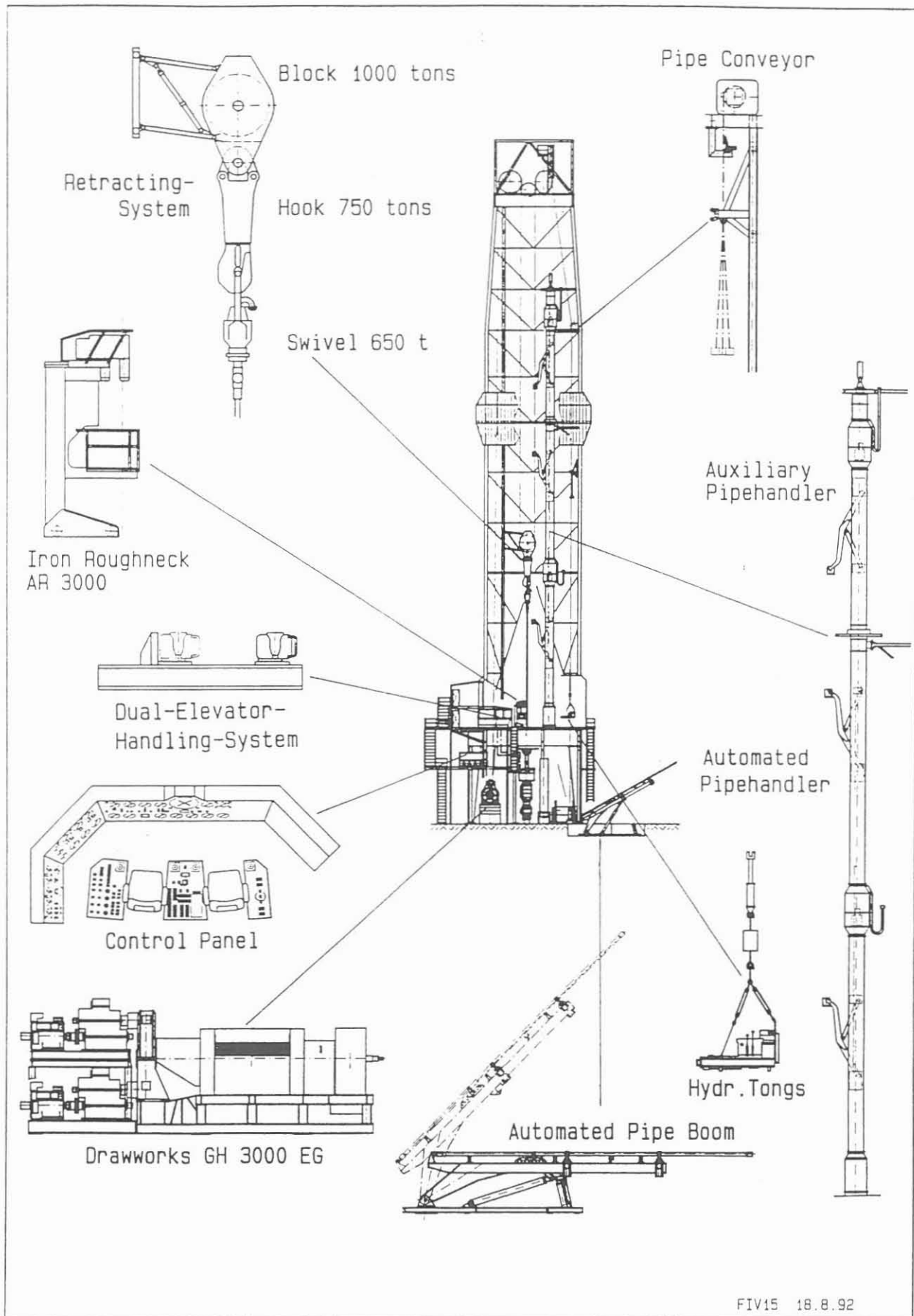
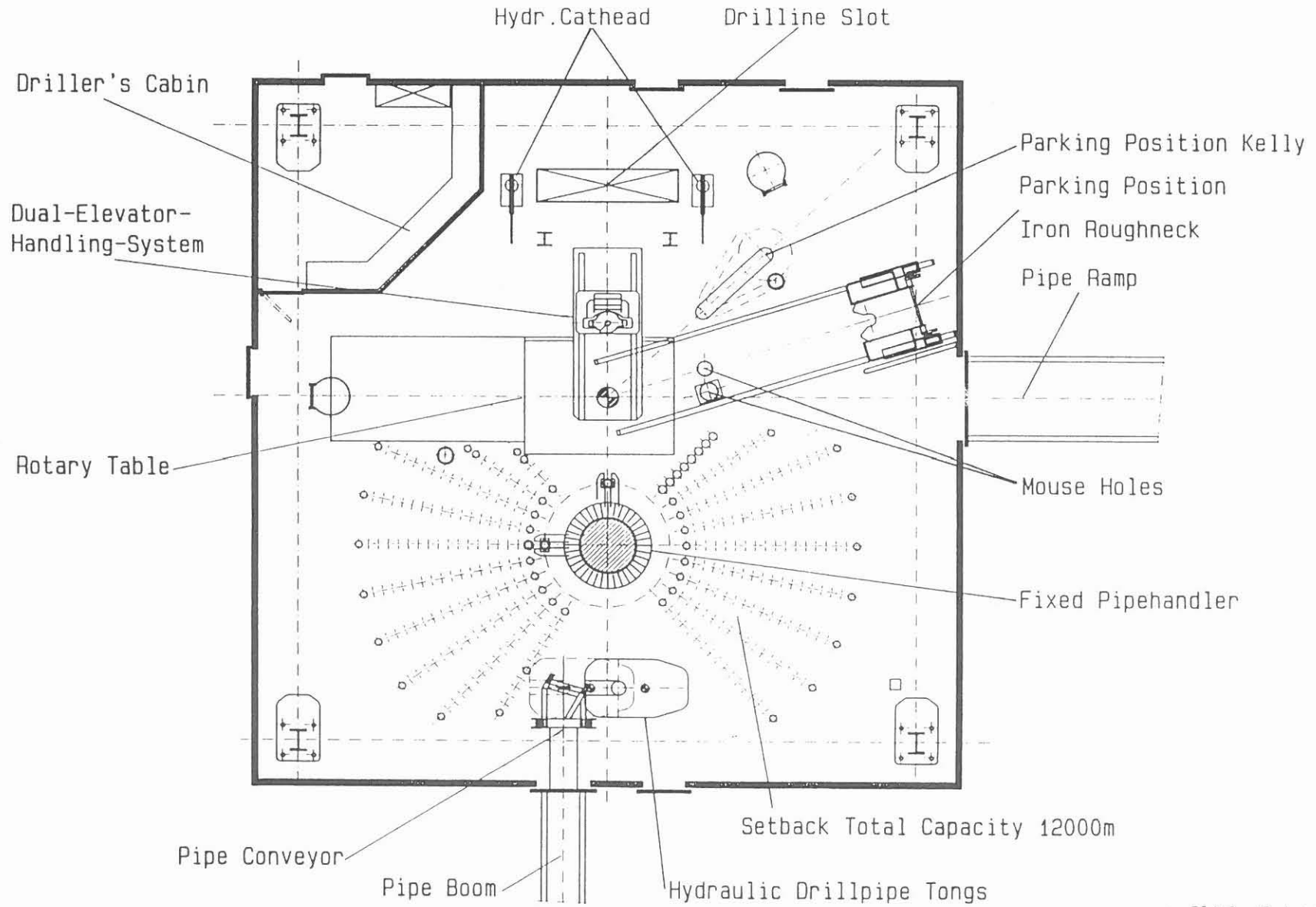

Fig. 2

Fig. 3



Technical Highlights of the UTB-Rig

47 Metric Tons Weight of Traveling Equipment

5.000 m of 1 3/4" Drilling-Line

18 3/4" - 10.000 psi BOP System, 4 Ram - 1 Annular BOP

83 m Mast Elevation

700 Metric Tons Casing Capacity

13,3 m Drillpipe Joint Length (Range III)

40 m Stand Length

5 1/2" DP °U 160 with NC56 Connectors

49 1/2" Independent Rotary-Drive

**Drawworks with Driving and Braking System
in 4 - Quadrant Method**

**Automatic Roughneck with Two Controlboxes c/w
Softclamp-System and Thread-Compensation**

8.900 h Operating Time for Mudpump-Liner

690.977 Ton-Kilometer Service on 5.000 m Drilling-Line

Fig. 4

UTB-1 Technical Specifications

1. Derrick		
Manufacturer		NOELL
Base		11,50 m x 11,50 m
Clear Height		63 m
Number of Lines		10 - 16
Max. Hook Load		8.500 kN
Nom. Gross Capacity		10.550 kN
Racking Capacity		12.000 m DP + DC
2. Substructure		
Manufacturer		DEILMANN
Rig Floor		13 m x 13 m
Height		11,75 m
Clear Height		9,50 m
Load Capacity		12.000 kN
3. Drawworks		
Manufacturer		WIRTH
Max. Input		2.200 kW
Operating Method		4 - Quadrant - DC
Max. Line Pull		750 kN
Max. Line Speed		20 m/s
Number of Speeds		4
Drill Line Diameter		1 3/4"
Feed-off-control		0 - 30 m/h
4. Mud Pumps		
Manufacturer		Wirth
Number of Units		2
Max. Input		1.240 kW, each
Manufacturer		LTV CONEMSCO
Number of Units		1
Max. Input		620 kW
5. Drive System		
Manufacturer		AEG
Type		SCR System
Mains		2 x 20 kV / 7.000 kVA
Number of Drive Motors		9 x DC
Manufacturer		SIEMENS
Max. Output		740 kW, each
6. Pipehandling		
Pipehandler		
Manufacturer		HITEC / VARCO
Height		53 m
Capacity		150 kN max.
DP Stand		40 m
Dual Elevator System		VARCO
Retractor		VARCO
Iron Roughneck		VARCO
Pipe Boom		DEILMANN
Pipe Conveyor		DEILMANN
7. Preventers		
Manufacturer		SHAFFER
Number of Units		4 x Ram + 1 x Annular
Opening		18 3/4"
Rating		700 bar
8. Mud Tank System		
Manufacturer		ITAG
Active Tank Volume		150 cbm
Reserve Tank Volume		300 cbm

Fig. 5

UTB Accident Statistics

Lost Time Injuries on Rigsite

Year h	Working hours	LTIs	LTI freq. rate	Injury
1990	23.132	1	43,2	Dropped tool hit foot
1991	59.032	2	33,9	Thumb squashed between tong jaws Slipped on iced stairs
1992	71.949	1	13,9	Slipped in mud ditch
1993	74.204	0	0,0	
1994	69.710	0	0,0	
Total	298.027	4	13,4	

Furthermore two industrial road accidents occurred.

Fig. 6

Operational Highlights from UTB-Rig Part 1

06-Okt-90	Spud In
20-Okt-90	Depth: 305 m (17 1/2")
02-Nov-90	Depth: 292 m (28")
03-Nov-90	First Casing Run 24 1/2" (290m)
12-Jan-91	1.000 m Depth (99 Days since Spud In)
30-Jan-91	Repair of Drawworks
23-Mär-91	2.000 m Depth (169 Days since Spud In)
20-Mai-91	Repair of Drawworks
28-Mai-91	3.000 m Depth (235 Days since Spud In)
07-Jun-91	Second Casing Run 16" (3.000,5 m)
27-Aug-91	4.000 m Depth (326 Days since Spud In)
21-Nov-91	5.000 m Depth (412 Days since Spud In)
13-Jan-92	Depth: 5.595,5 m
16-Jan-92	Plugged Back to 5.518,5 m
22-Jan-92	Re-Drilled to 5.595,5 m
05-Mär-92	6.000 m Depth (517 Days since Spud In)
16-Mär-92	World First Frequency Controlled AC-Rotary Drive in Operation (1.000 HP)
05-Apr-92	Third Casing-Run 13 5/8" and 13 3/8" (6.013,5 m)
15-Mai-92	First Dual-Elevator-Handling-System Testrun
04-Jun-92	First Operation with 9 1/2" Coring-System
29-Jul-92	Depth: 6760,5 m
04-Aug-92	Plugged Back to 6.619,5 m
08-Aug-92	Re-Drilled to 6.685 m
18-Aug-92	Top Fish: 6.648,6 m
22-Aug-92	Plugged Back to 6.515 m
07-Sep-92	Re-Drilled to 6.577,7 m
09-Sep-92	Plugged Back to 6.403 m
20-Nov-92	Dual-Elevator-Handling-System in Operation

Fig. 7a

Operational Highlights from UTB-Rig Part 2

21-Nov-92	First Operation with Drillpipe U-160
29-Nov-92	Re-Drilled to 6.760,5 m
02-Dez-92	6.775 m West German Well Lilienthal
18-Dez-92	7.000 m Depth (805 Days since Spud In)
24-Jan-93	Depth: 7.219,5 m
14-Feb-93	Drill Stem Failure
08-Mär-93	Plugged Back to 7.100 m
15-Apr-93	Re-Drilled to 7.219,5 m
04-Jun-93	Changed First 5.000 m Drilling Line
23-Jul-93	8.000 m Depth (1.022 Days since Spud In)
23-Jul-93	8.008,5 m National Drilling Record, Mirow, East Germany
07-Sep-93	Depth: 8.328,2 m
07-Sep-93	Wash-Out in 5" DP °U 170
18-Sep-93	Downhole Motor Failure, Top Fish: 7.522,7 m
06-Okt-93	Changed Second Drilling Line
12-Okt-93	Plugged Back and Set Whipstock at 7.434,7 m
07-Dez-93	RIH 9 5/8" Liner to 7.784,8 m
13-Jan-94	Re-Drilled to 8.328,2 m
21-Jan-94	Depth: 8.500 m (1.204 Days since Spud In)
04-Apr-94	Depth: 8.729,7 m
17-Apr-94	5 1/2" DP °S Failed while Reaming, Top Fish: 7.261 m
15-Mai-94	RIH 7 5/8" Liner with Integrated Whipstock to 8.665 m, Unsuccessfull Kick-Off
22-Jul-94	Kick-Off Successfull after Several Cement Jobs
07-Aug-94	Re-Drilled to 8.729,7 m
05-Sep-94	Deepest Fishing Job in the Well: 8.895,8 m
12-Sep-94	Two Years Accident Free Operation on Rig
27-Sep-94	Depth: 9.000 m (1.453 Days since Spud In)
30-Sep-94	9.043 m: Fourth Deepest Well Worldwide
12-Okt-94	End of Drilling Phase after 1.568 Days since Spud In Depth: 9.101 m, Hole Diameter: 6 1/2"

Fig. 7b

Operating Hours of UTB-Equipment

Spud-In: 06. Oct. 1990

End of Drilling Phase: 12. Oct. 1994

Item	Operating Hours
Drawworks	
Auxiliary Systems	28.778
Triptime	13.362
Drilling Time	8.961
Mudpump I	21.129
Mudpump II	20.622
Mudpump III	10.496
Independent Rotary Drive	10.494
Pipe Boom	747
Main Hydraulic Unit	14.224
Pipehandler	approx. 2.615
Automatic Roughneck	approx. 1.810
Number of Roundtrips	493

Fig. 8

Fig. 9

KTB - Time Breakdown

Spud in until 9101m

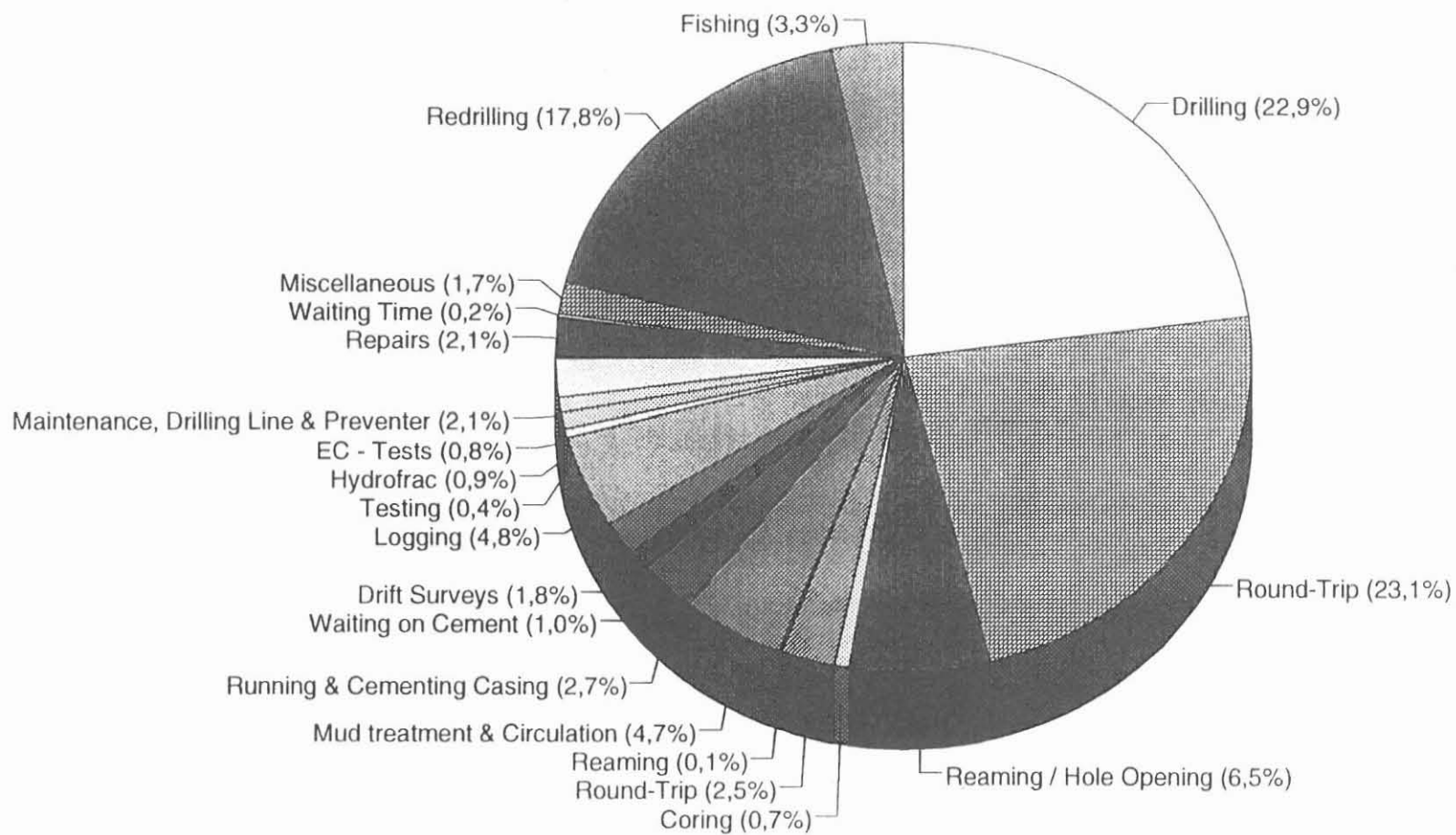

Time Breakdown Comparison

KTB - Well vs. Two Deep Gaswells

KTB		Gaswell 1		Gaswell 2		
h	%	h	%	h	%	
						Drilling related time
8.063	27,8	1.826	37,7	1.166	42,5	Drilling
8.151	28,2	907	18,7	398	14,5	Round-Trip
2.289	7,9	202	4,2	67	2,4	Reaming / Hole Opening
						Expected non productive time
1.673	5,8	44	0,9	24	0,9	Mud treatment & Circulation
951	3,3	244	5,0	272	9,9	Running & Cementing Casing
346	1,2	187	3,9	225	8,2	Waiting on Cement
634	2,2	106	2,2	59	2,1	Drift Surveys
272	0,9		0,0		0,0	EC - Tests
723	2,5	116	2,4	36	1,3	Maintenance, Drilling Line & Preventer Check
						Unexpected non productive time
1.158	4,0	476	9,8	50	1,8	Fishing
740	2,6	159	3,3	51	1,8	Repairs
66	0,2	151	3,1	75	2,7	Waiting Time
						Scientific time
244	0,8	22	0,4	25	0,9	Coring
870	3,0	87	1,8	93	3,4	Round-Trip
49	0,2	17	0,3	20	0,7	Reaming
1.676	5,8	308	6,4	152	5,5	Logging
156	0,5		0,0		0,0	Testing
307	1,1		0,0		0,0	Hydrofrac
586	2,0		0,0	32	1,2	Miscellaneous
28.955	100,0	4.849	100,0	2.741	100,0	Total

Fig. 10

Fig. 11

Time Breakdown Comparison

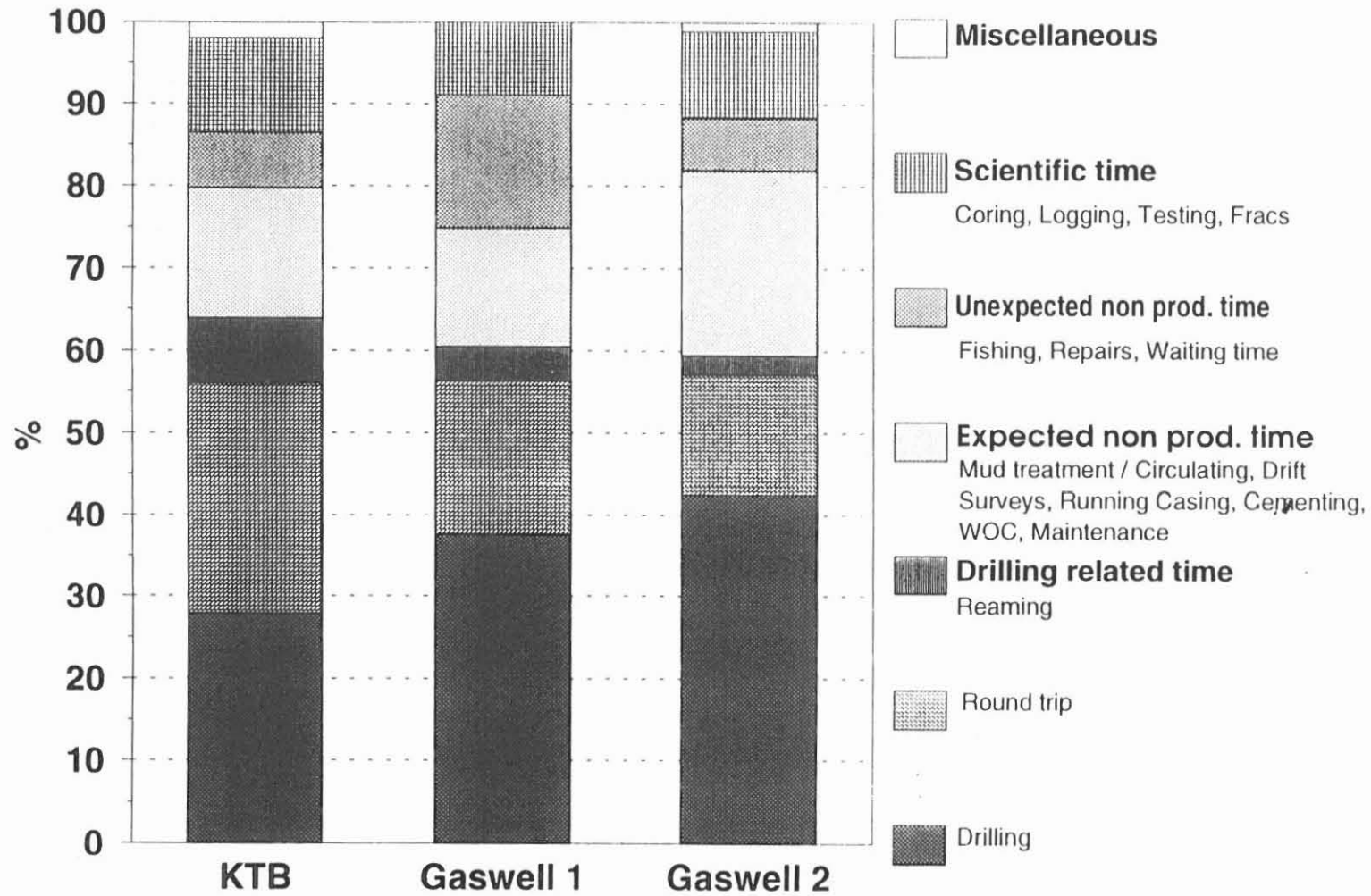

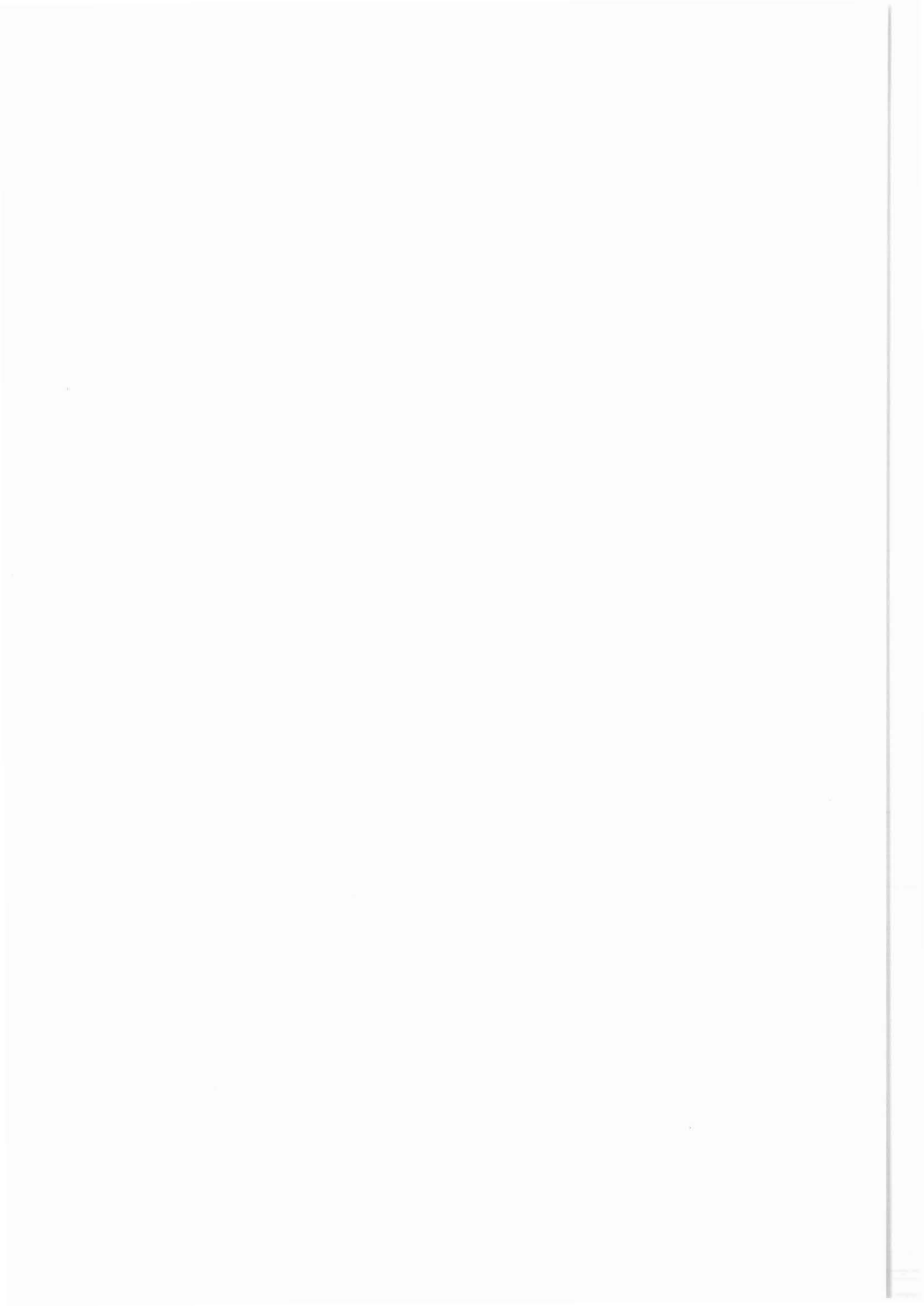

**DOWNHOLE MEASUREMENT
TECHNOLOGY**

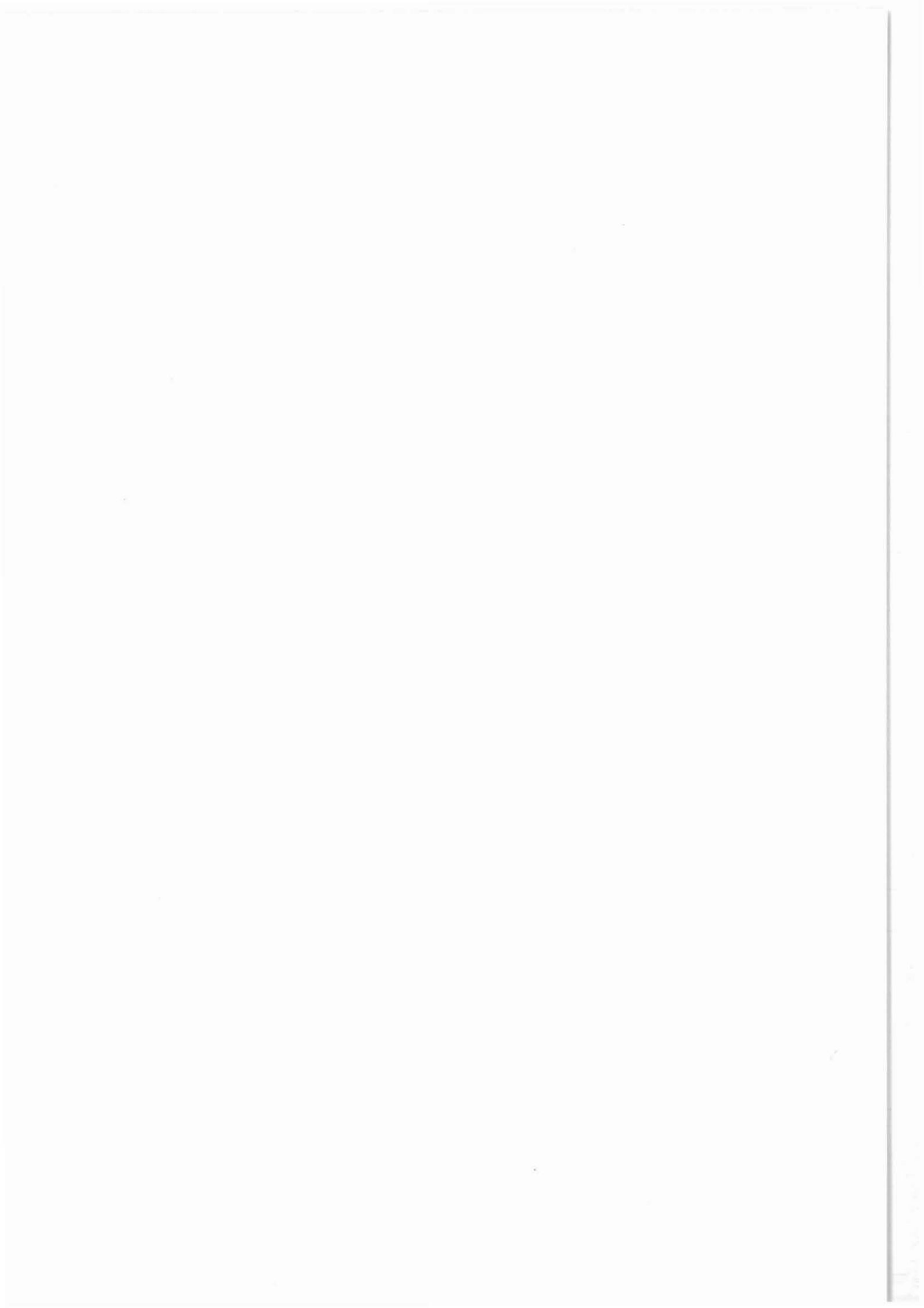

Logging while Drilling and other new logging technologies
- Their potential for lithosphere research -

C. Boyeldieu

Services Techniques Schlumberger
50 avenue Jean Jaurès
92541 Mountrouge / France

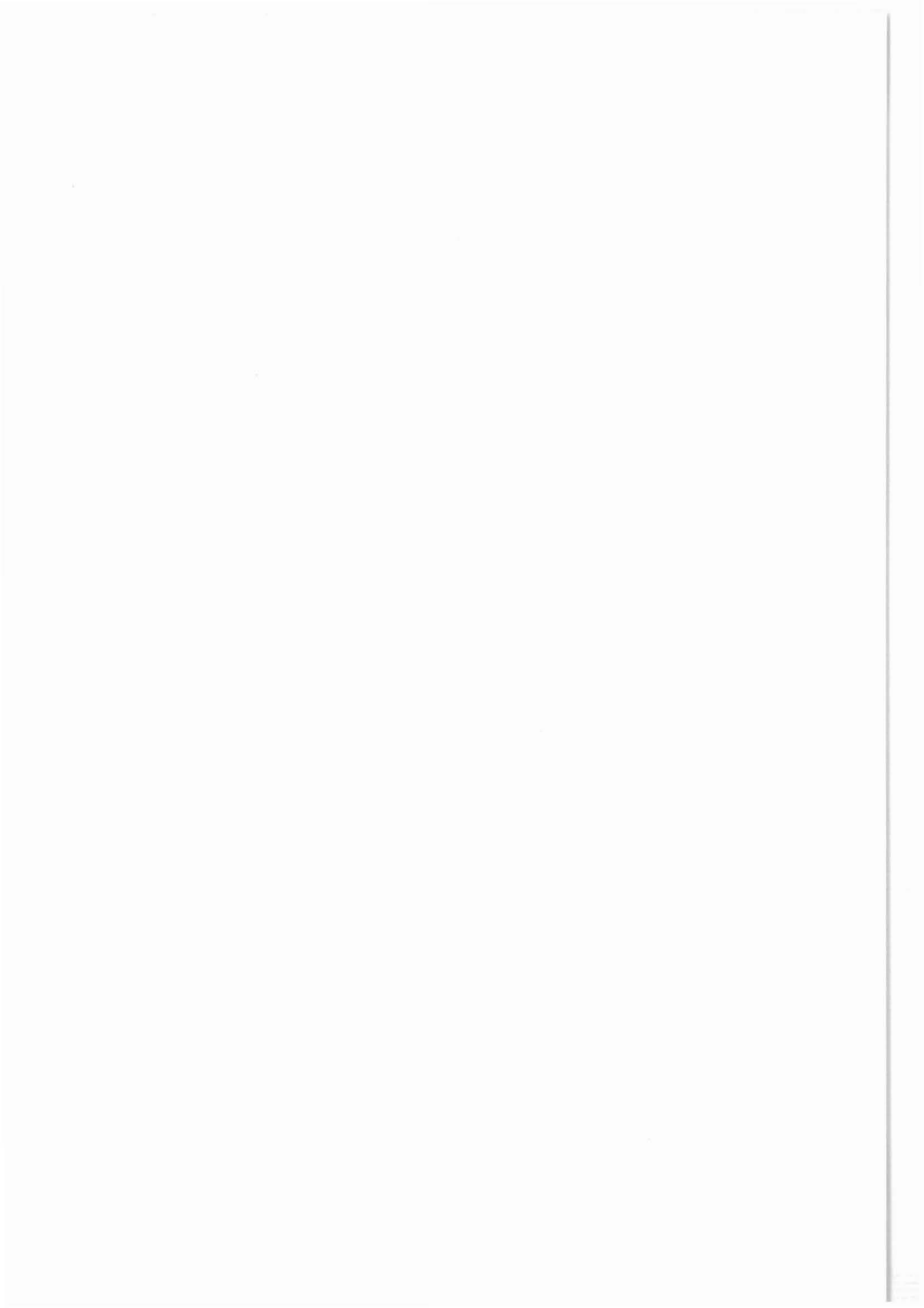

SCIENTIFIC CONTINENTAL DRILLING
POTSDAM

**LOGGING WHILE DRILLING
AND OTHER NEW LOGGING TECHNOLOGIES,
THIER POTENTIAL FOR LITHOSPHERE RESEARCH**

Claude Boyeldieu

Services Techniques Schlumberger
50 avenue Jean Jaurès, 92541 Montrouge, France

Abstract

During the past 7 years, the Logging While Drilling domain has seen the introduction of several new tools and the improvement of the performance and reliability of this logging technique. Introduced in the early 70s the Logging While Drilling has consisted during many years in the recording of a Gamma Ray and of a standard Normal Resistivity curve. The development of the sensor technology as well as the capability to memorize large quantities of data downhole, when still transmitting a limited rate of data in real time, has allowed the introduction of two basic LWD strings, the CDR* consisting of a Natural Gamma Ray Spectrometer sensor and of a Dual Electromagnetic Propagation antenna (Fig. 1), and the CDN*, regrouping the Compensated Neutron Porosity tool and the Litho-Density one (Fig. 2). Such devices were allowing the recording, in water and oil base muds of the very standard logs as done with wireline logging techniques.

More recently a (rotating) Ultrasonic Caliper was added to the LWD string giving the borehole cross section of the well short after drilling (Fig. 3 - 5). (Note: It has to be remembered, that the LWD strings not only allow the recording of the various petrophysical parameters during drilling, but also after pulling out or when reentering a well).

The latest development concern the addition of an Acoustic Device and of a Laterolog and "Resistivity at the BIT (RAB)*". This Laterolog device is rated up to 20,000 ohm/m allowing its use in hard rock formations (Fig. 6 - 8). It should have soon an azimuthal capability for the Laterolog but also for the combination Neutron Porosity / Litho-Density. Also to be mentioned, the development of a Seismic While Drilling system (Fig. 9).

These devices permit a much faster evaluation of the formations encountered during the drilling, easing the decision making process, the geosteering of horizontal wells but also allowing the logging of difficult wells.

Traditional logging techniques have seen the introduction of several tools providing huge amounts of recorded data, which can then be studied on the screen of the computer workstations, giving an Image of the resistivity of the borehole wall, or of the resistivity variations around the well, or of the radial and vertical variations of the impedance of the formations. They are:

- AIT* - Array Induction Imager
- DSI* - Dipole Shear Sonic Imager
- FMI* - Fullbore Formation Micro Imager
- ARI* - Azimuthal Resistivity Imager
- UBI* - Ultrasonic Borehole Imager

AIT - Array Induction Imager (Fig. 10 - 12)

28 independent conductivity signals are provided by 8 induction arrays working at 2 frequencies and recording the R and X signals. The results are 5 conductivity curves at 10-20-30-60 and 90 in. depths of investigation, 1-2 and 4 ft vertical resolution and an image of the vertical and radial distribution of resistivity (invasion profile).

DSI - Dipole Shear Sonic Imager (Fig. 13 - 15)

A monopole transmitter, 2 dipole transmitters, 8 receiver stations spaced 6 in. apart vertically and each station consisting of 4 hydrophone elements allow the recording of enhanced measurements of compressional, shear and Stoneley waveforms in all formations. The principal applications added to the classical Sonic porosity concern the well stability, sanding analysis, fracture estimation, shear seismic correlation and rock mechanics. An estimation of the permeability can also be made.

FMI - Fullbore Formation Micro Imager (Fig. 16 - 19)

Increasing the number of pads to 8, setting 24 electrodes per pad, a near fullbore capability was achieved using the principle of the past FMS - Formation MicroScanner. The result is an highly detailed image of the resistivity variations of the borehole wall. Detailed dip computation, fractures, heterogeneities will be quantified.

ARI - Azimuthal Resistivity Imager (Fig. 20 - 22)

It is an improved Dual Laterolog associated with a deep azimuthal focused, high resolution resistivity array. The array provides 12 deep, oriented

resistivity measurements. This new tool can be run in combination with the FMI. A borehole image is provided as well as dip computations and fracture evaluation.

UBI - Ultrasonic Borehole Imager (Fig. 23 - 25)

Introduced recently, replacing the Borehole Televiwer, the UBI is an open hole adapted version of the USI - Ultrasonic Imager used in the cement and corrosion evaluation. High sampling scanning of the wellbore provide "transit-time" and "amplitude" oriented images of the borehole wall. It gives a very exact picture of the breakout zones, of the open fractures and highly precise borehole irregularities.

Borehole imaging is only a very practical way to present rapidly a limited amount of the recorded data loaded in the workstation. Far more can be obtained from these data by the geologist, the geophysicist or the petrophysicist manipulating, interpreting them on the computer workstation (Fig. 26).

If fracture analysis has gained an accuracy, macro-texture can also, now, be analysed. The image will also allow a better understanding of the validity and use of the computed dip values, easing the drawing of geological cross sections.

* Mark of Schlumberger

CDR* Compensated Dual Resistivity Tool

High-frequency induction
(2 MHz) capable of operating
in all mud types

Borehole compensation

Two depths of investigation:
medium (R_{ps}) and deep (R_{ad})

Spectroscopic gamma ray

Available in 6.5-, 8- and
9.5-in. drill collars

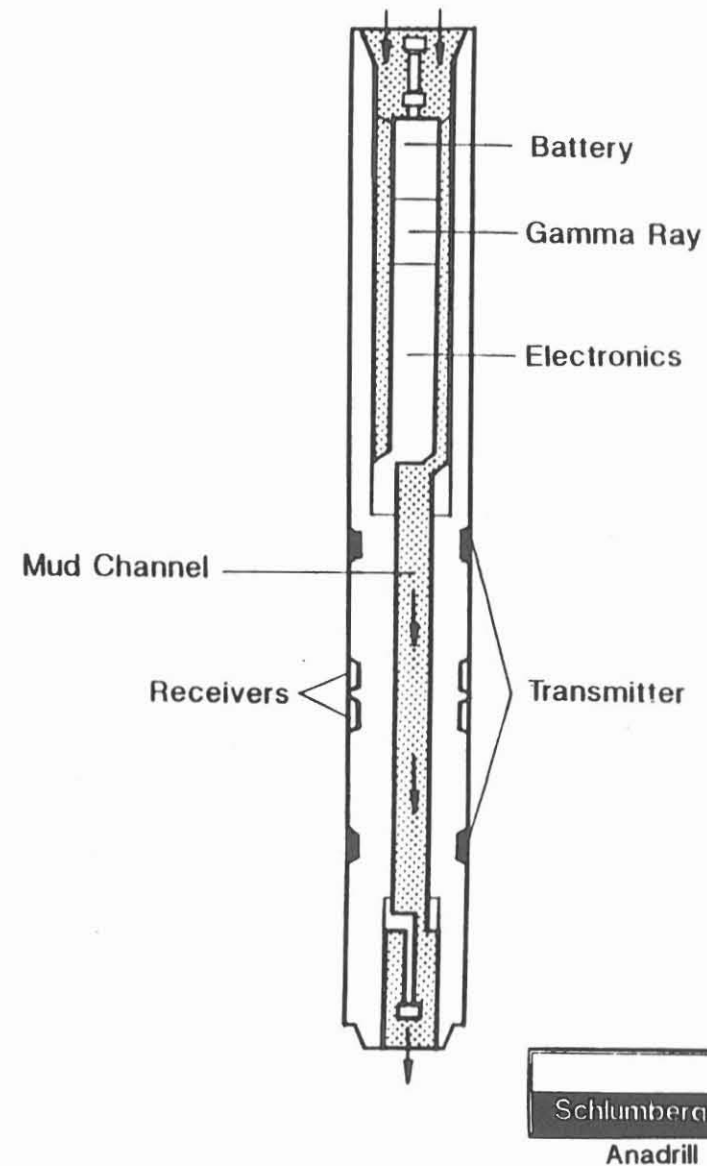

Fig. 1

* Mark of Schlumberger

CND* Compensated Density Neutron Tool

Compensated thermal neutron porosity

Compensated lithology density

Retrievable sources

Available in 6.5- and 8-in. drill collars

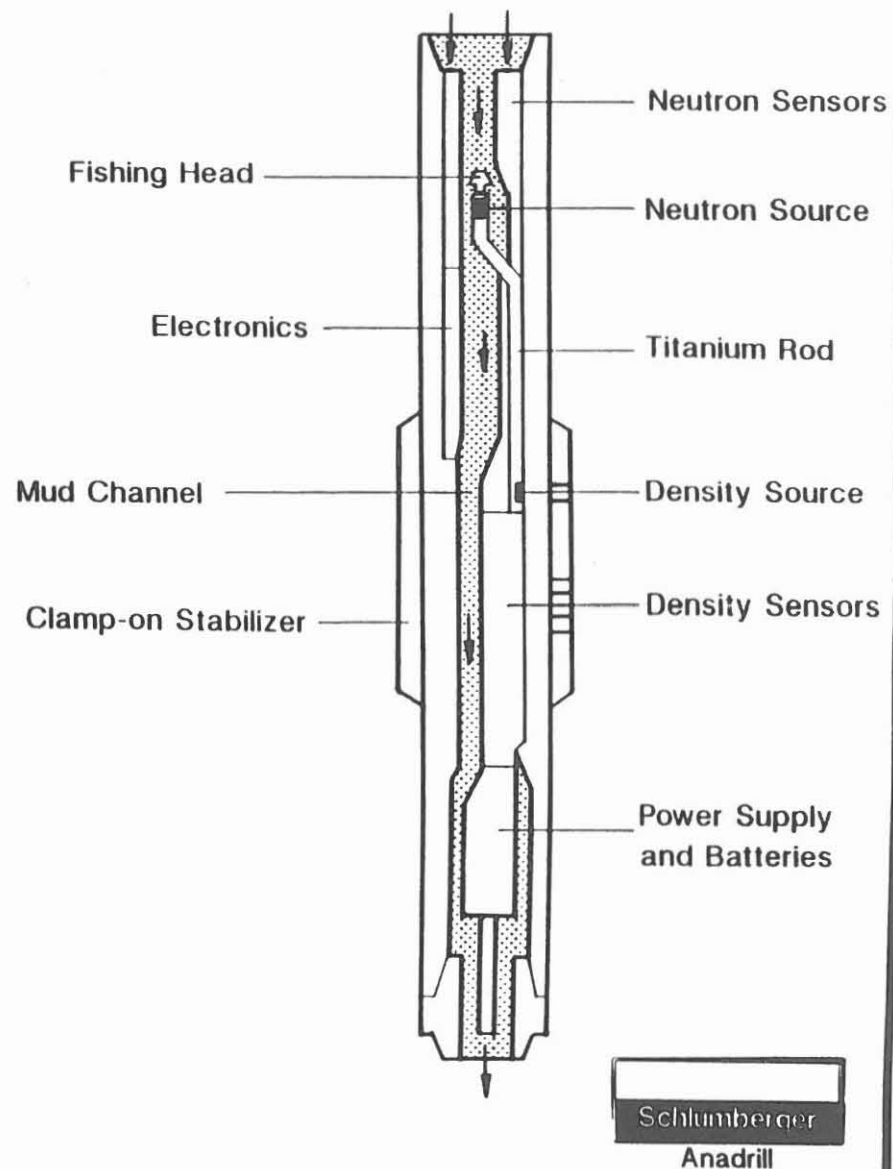

Fig. 2

* Mark of Schlumberger

Ultrasonic Sensor Measurement

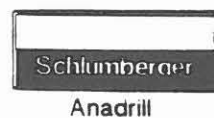
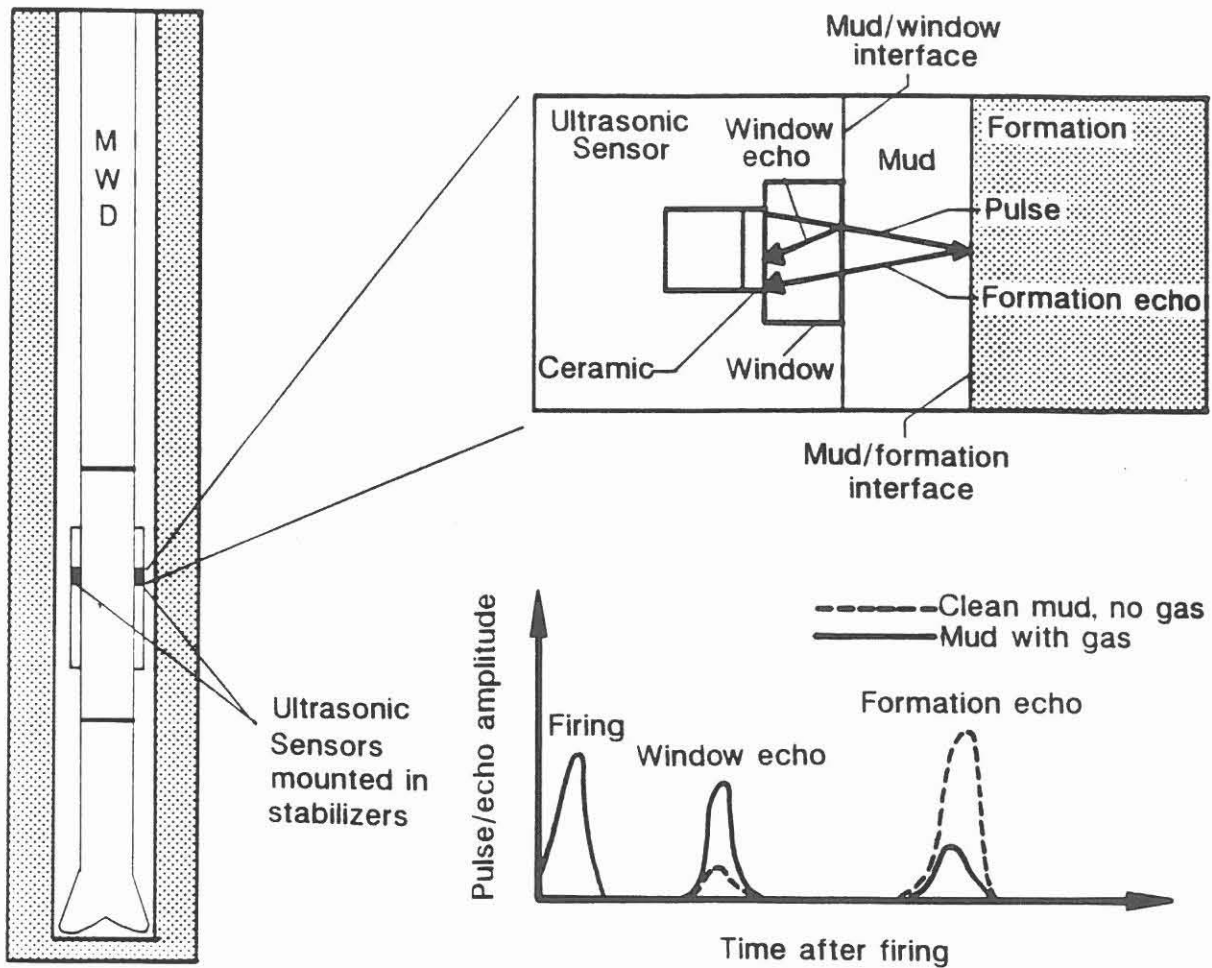

Fig. 3

Ultrasonic Measurement while Drilling

Caliper measurement

- Wash-out detection
- Key seat
- Tight hole requiring reaming
- Borehole stability in general
- Environmental correction of other LWD logs

Sonic measurement

- Formation velocity before mud alteration
- Fault zone detection
- Lithology information

Downhole Gas influx detection

- Improved drilling safety

Fig. 4

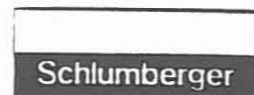

Anadrill

HOLE DIAMETER CALCULATION

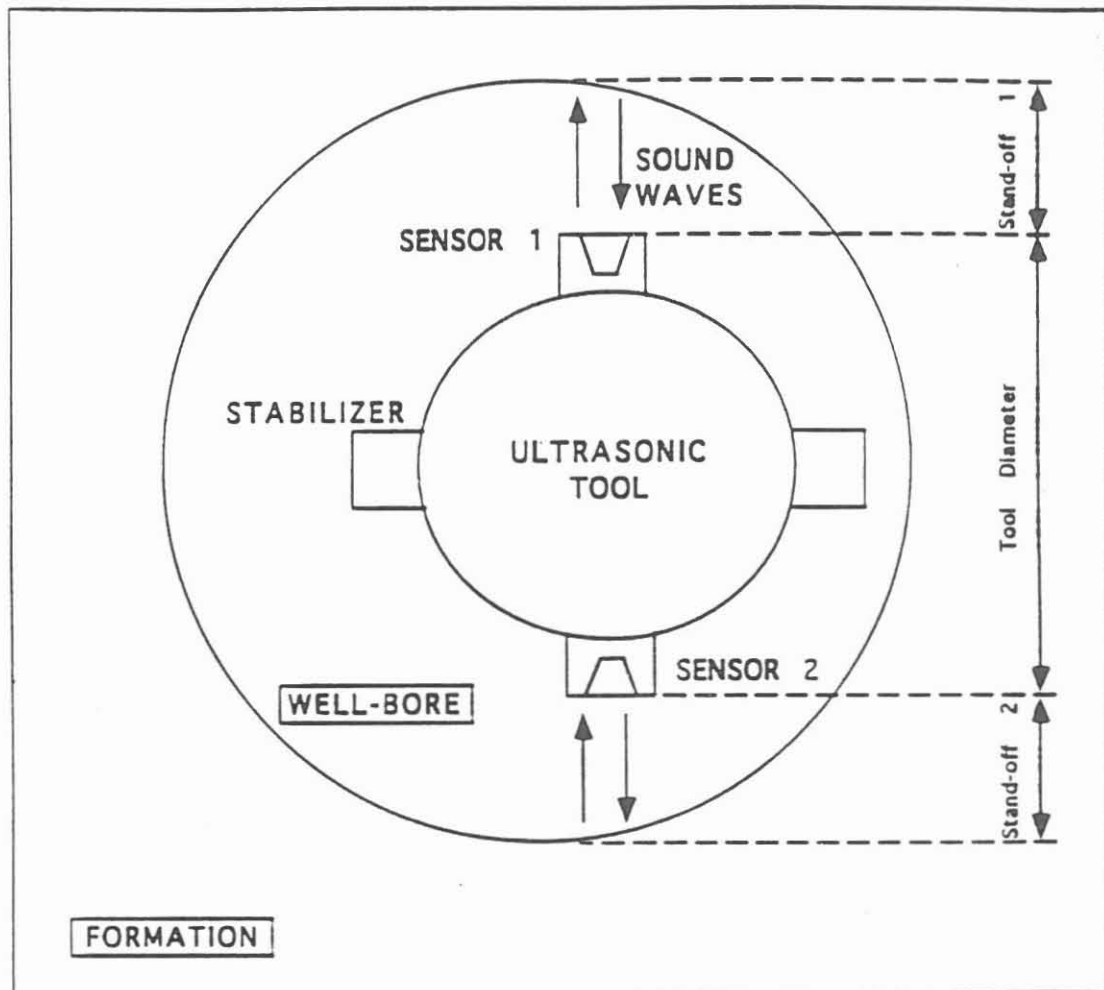

$$\text{STAND-OFF} = (\text{ECHO ARRIVAL TIME} - \text{WINDOW ARRIVAL TIME}) \times \text{SPEED OF SOUND}$$
$$\text{HOLE DIAMETER} = \text{STAND-OFF (SENSOR 1)} + \text{STAND-OFF (SENSOR 2)} + \text{TOOL DIAMETER}$$

Fig. 5

Resistivity Measurements at the BIT (RAB)*

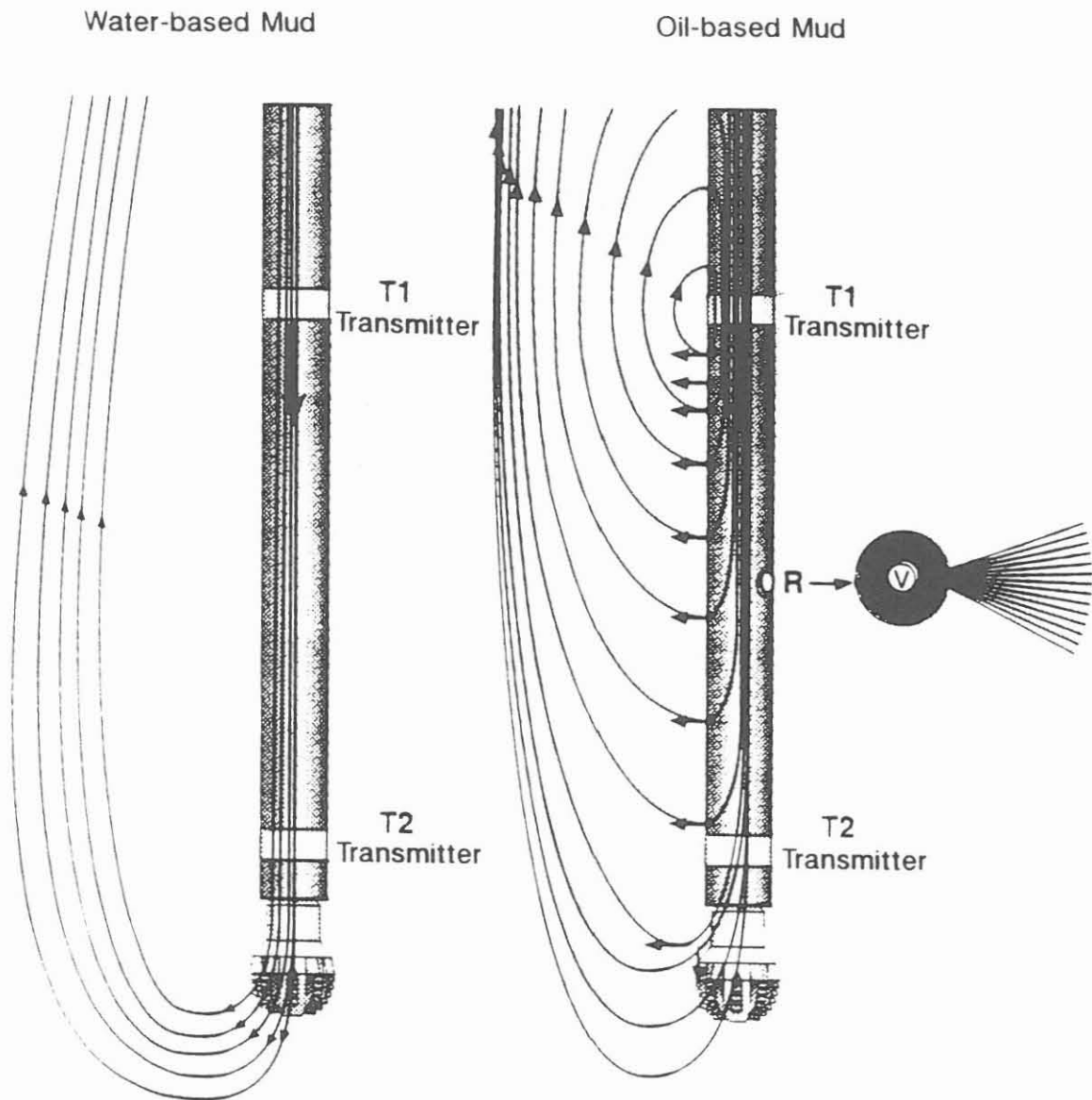

Fig. 6

Schlumberger
Anadrill

* Mark of Schlumberger

Resistivity Measurement at the Bit (RAB)*

Benefits

- Measurement electrode is at the drill bit
- Clear detection of coring or casing points
- Lithology information
- Laterolog-type resistivity measurement minimizes shoulder bed effects
- R_t in thin beds and high-resistivity formation drilled with salt-saturated mud
- Azimuthal button electrodes provide roof/floor resistivities in horizontal wells
- Invasion detection
- Detection of permeable zones
- Detection of loss circulation zones
- Large downhole memory for detailed data storage required for complete formation evaluation after tripping

* Mark of Schlumberger

Tool Configurations: Geosteering and RAB*

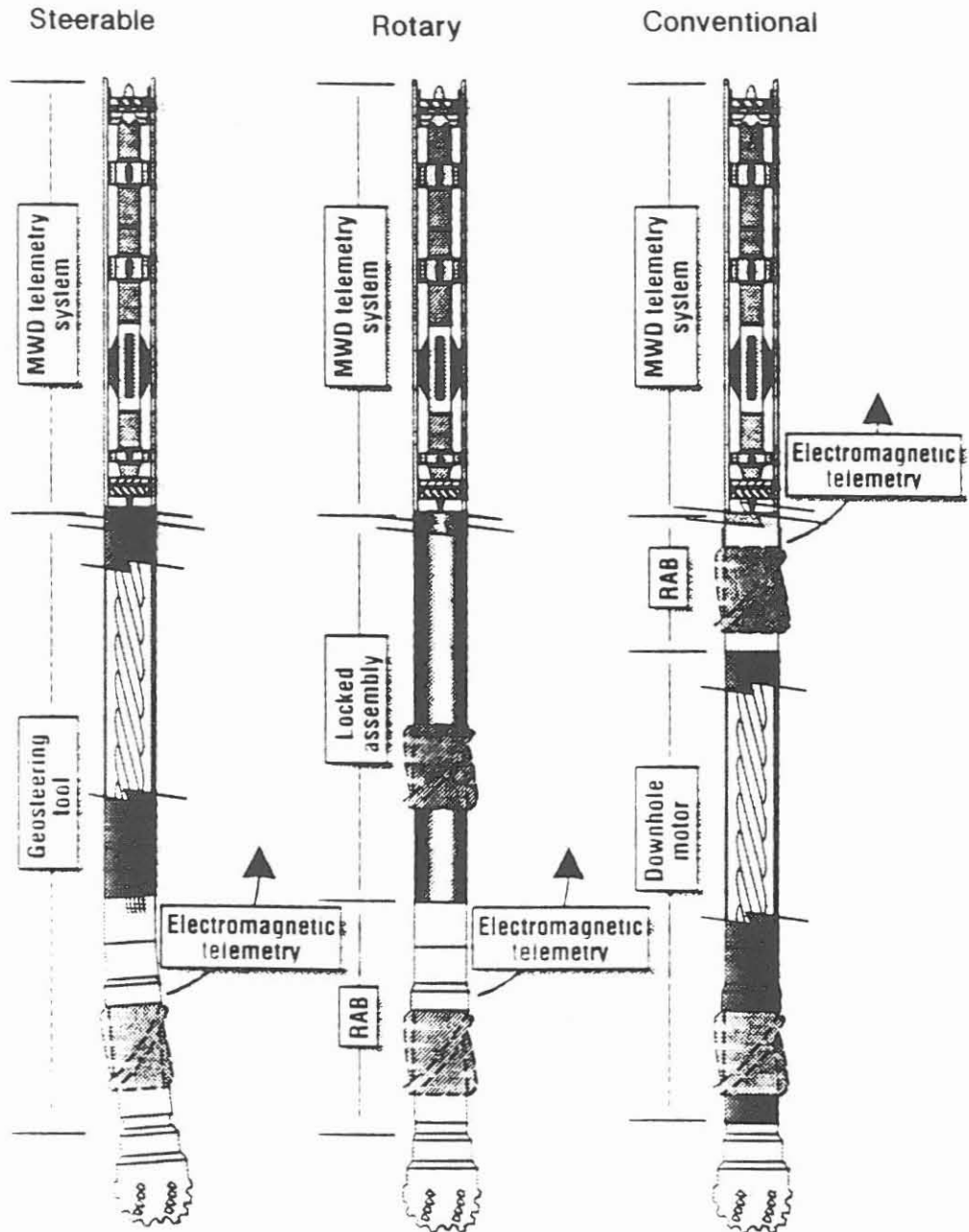

Fig. 8

Schlumberger
Anadrill

* Mark of Schlumberger

Seismic While Drilling - Checkshot While Drilling

STATUS OF CWD

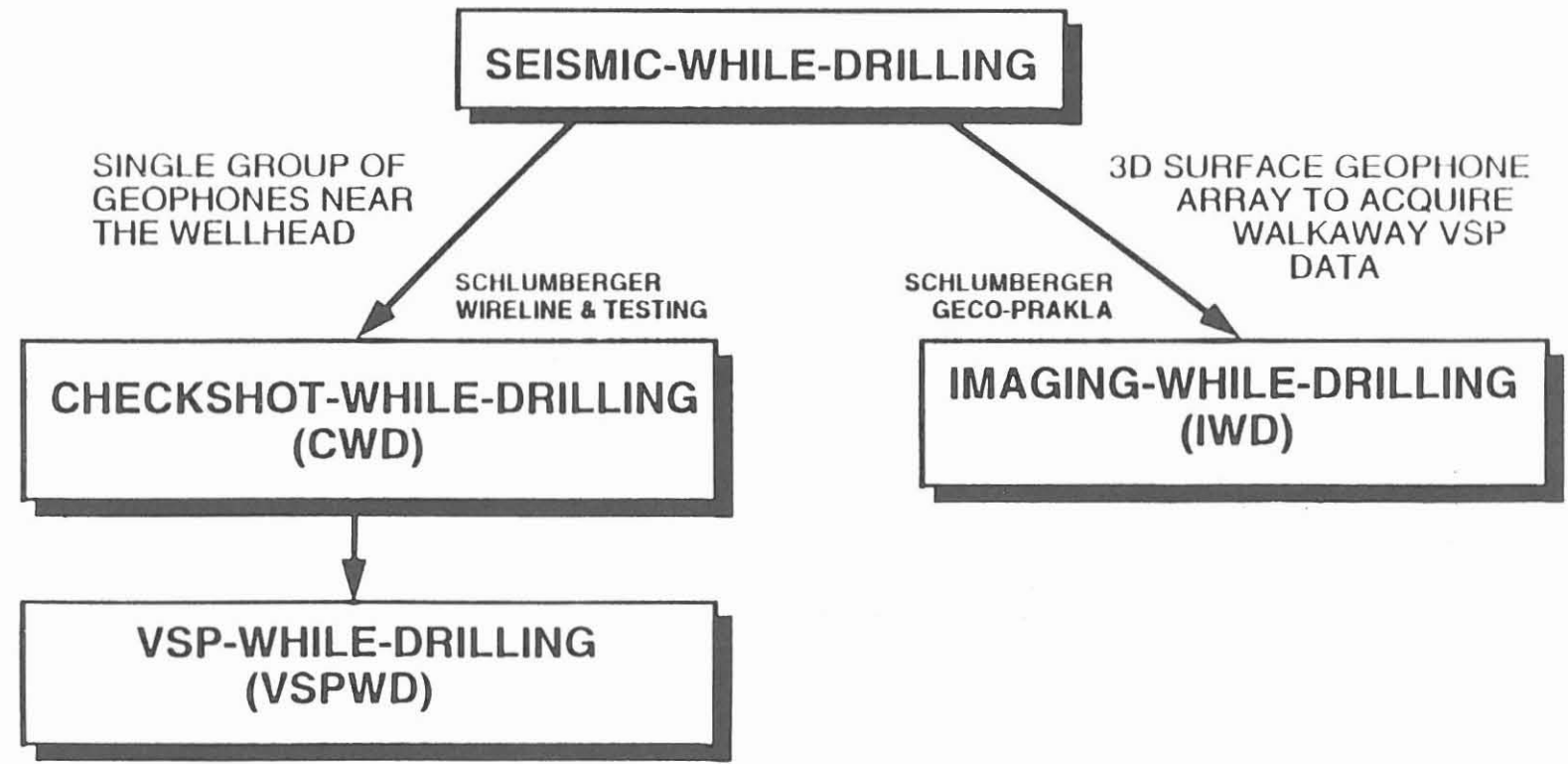

Fig. 9

Array Induction Imager (AIT) ★

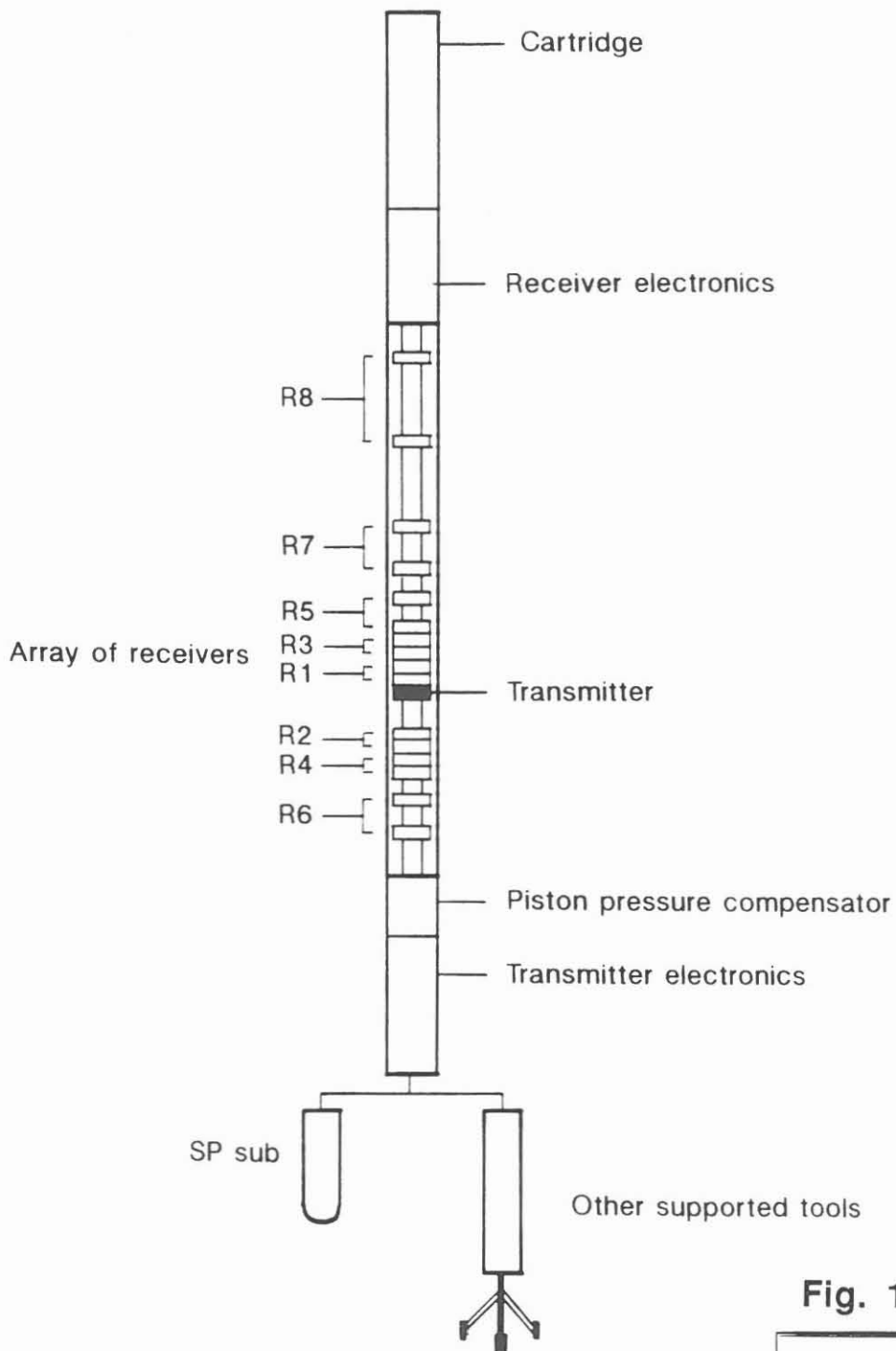

Fig. 10



Array Induction Imager (AIT)* Tool Specifications

Logging speed	3 600 ft/hr (1097 m/hr)
Operating temperature	-15°F to 350°F (-25°C to 175°C)
Operating pressure	20 000 psi (1400 bars)
Minimum borehole diameter	4.75 in. (12 cm)
Tool length	
With SP	40.3 ft (12.3 m)
Without SP	33.5 ft (10.2 m)
Tool diameter	3 7/8 in. (9.9 cm)
Tool weight	575 lbm (261 kg)
Combinability	Top and bottom

* Mark of Schlumberger

Fig. 11

Schlumberger

Array Induction Imager (AIT)*

Benefits

28 borehole-corrected induction measurements

8 arrays, 2 frequencies, R and X signals

Thin bed analysis by one foot vertical resolution

Formation description by five different depths of investigation

Invasion profile computation takes on added dimensions

Color images give a new way to look at resistivity and saturation

Unique quality control device functions like a backup tool

Combinability saves logging trips

Downhole mud resistivity or borehole size can be computed from AIT signals

* Mark of Schlumberger

Fig. 12

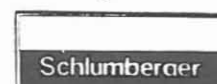

Dipole Shear Sonic Imager (DSI) *

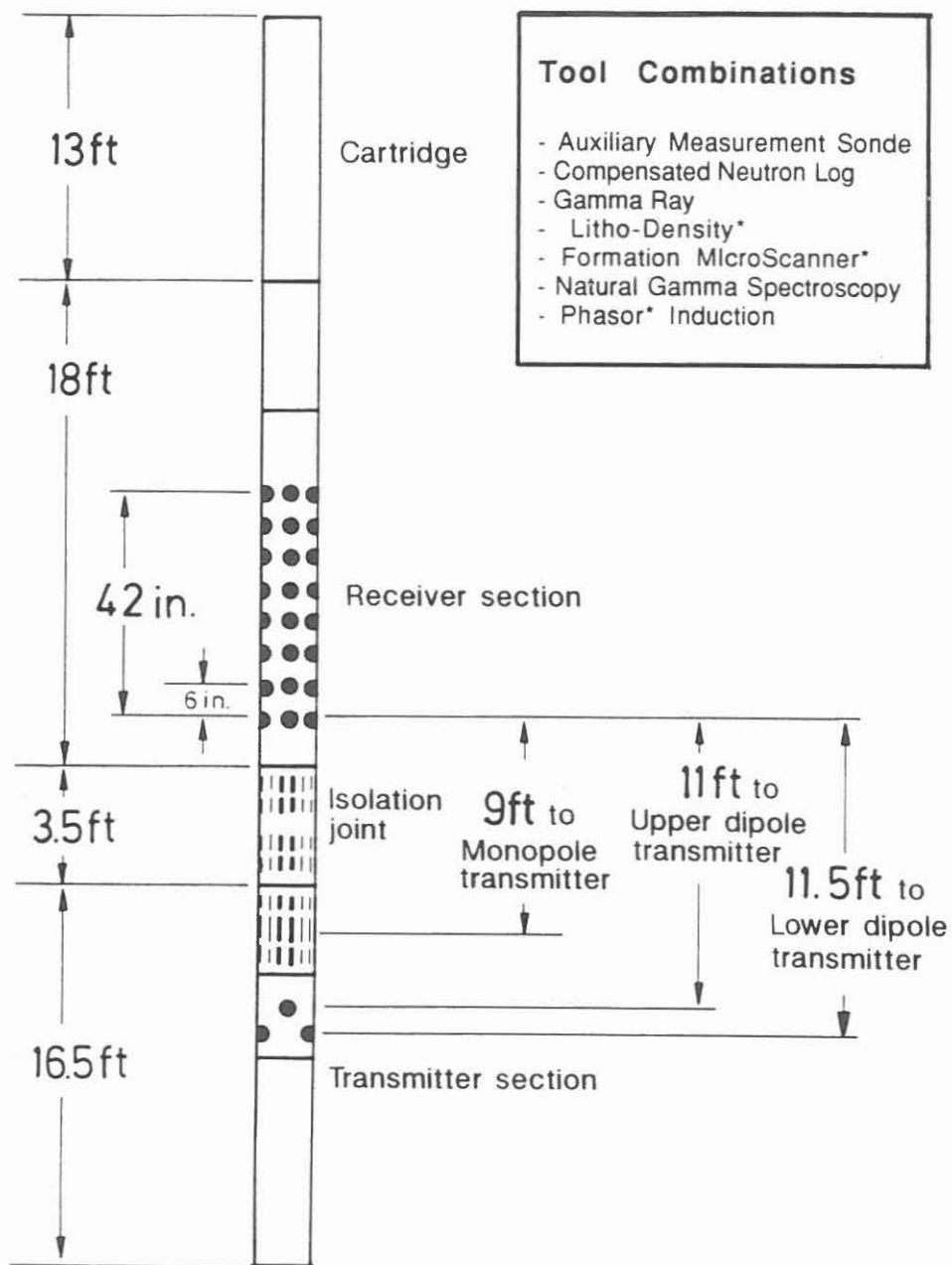

Fig. 13

* Mark of Schlumberger

Dipole Shear Sonic Imager (DSI)*

Tool specifications

Temperature rating	350 °F (175 °C)
Pressure rating	20 000 psi (1400 bar)
Tool diameter	3 5/8 in. (9.2 cm)
Tool length	51 ft (15.5 m)
Maximum logging speed	1800 ft/hr for one 8-waveform set (single mode)
Digitizer precision	12 bits
Digitizer sampling interval limits	10 ms - 32.7 ms/sample
Digitizer wave duration limits	15 000 samples/all waveforms
Acoustic band width	80 Hz - 5 kHz dipole and Stoneley 8 kHz - 30 kHz high frequency monopole
Operational modes	Upper and lower dipole Crossed dipole Stoneley P and S First motion

Fig. 14

* Mark of Schlumberger

Dipole Shear Sonic Imager (DSI)*

Benefits

Direct downhole P-, S- and Stoneley-waveform measurements

Analysis of waveforms by Slowness-Time-Coherence (STC) processing

Improved borehole compensated standard and long-spacing sonic measurements by processing of signals from receiver array

Oriented dipole sources and receivers allow directional wave propagation

Applications

Formation evaluation

Better porosity evaluation by improved sonic velocities

Gas detection

Fracture evaluation

Qualitative indication of permeability

Mechanical properties analysis

Rock strength, stress, rock failure mechanism

Wellbore stability - sanding problems

Hydraulic fracture height determination

Geophysical application

Improvement of synthetic seismograms, VSP's

Detection of gas-related amplitude anomalies

Amplitude variation with offset

Fig. 15

* Mark of Schlumberger

Formation Microlmager (FMI) *

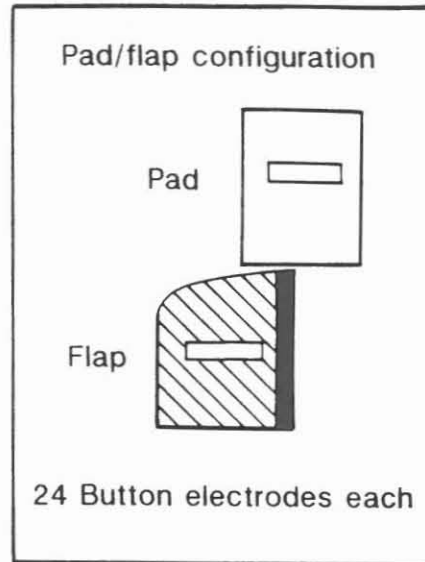
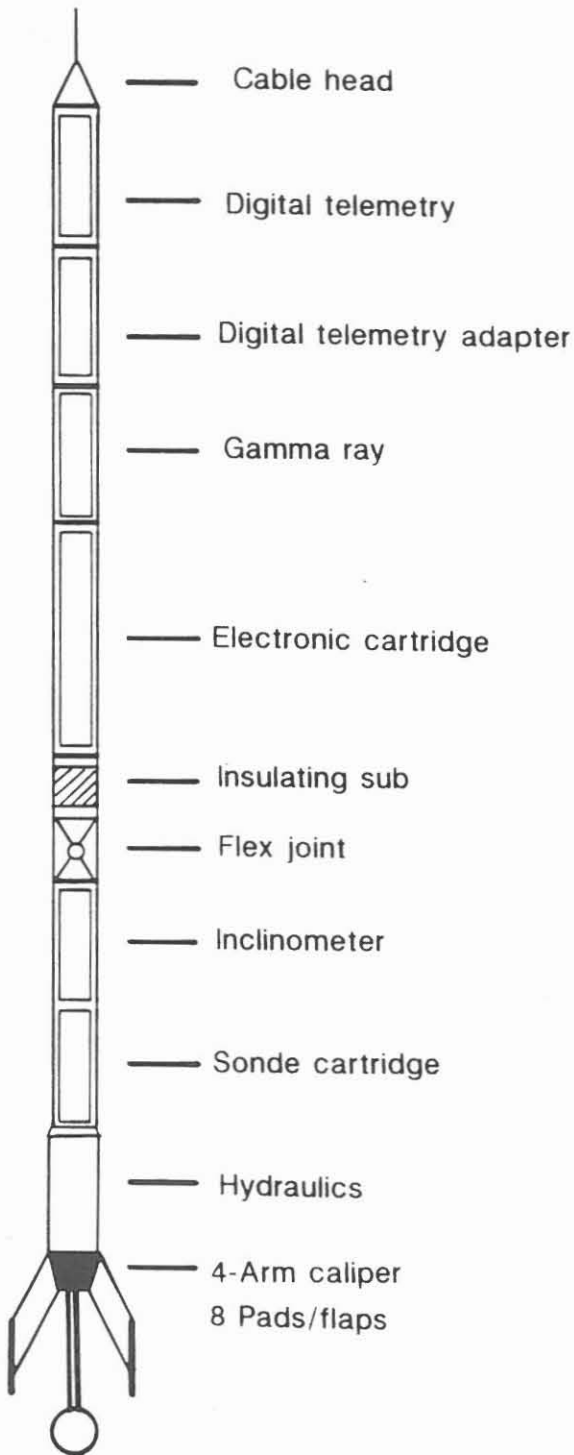

* Mark of Schlumberger

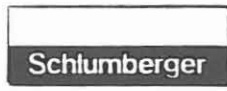
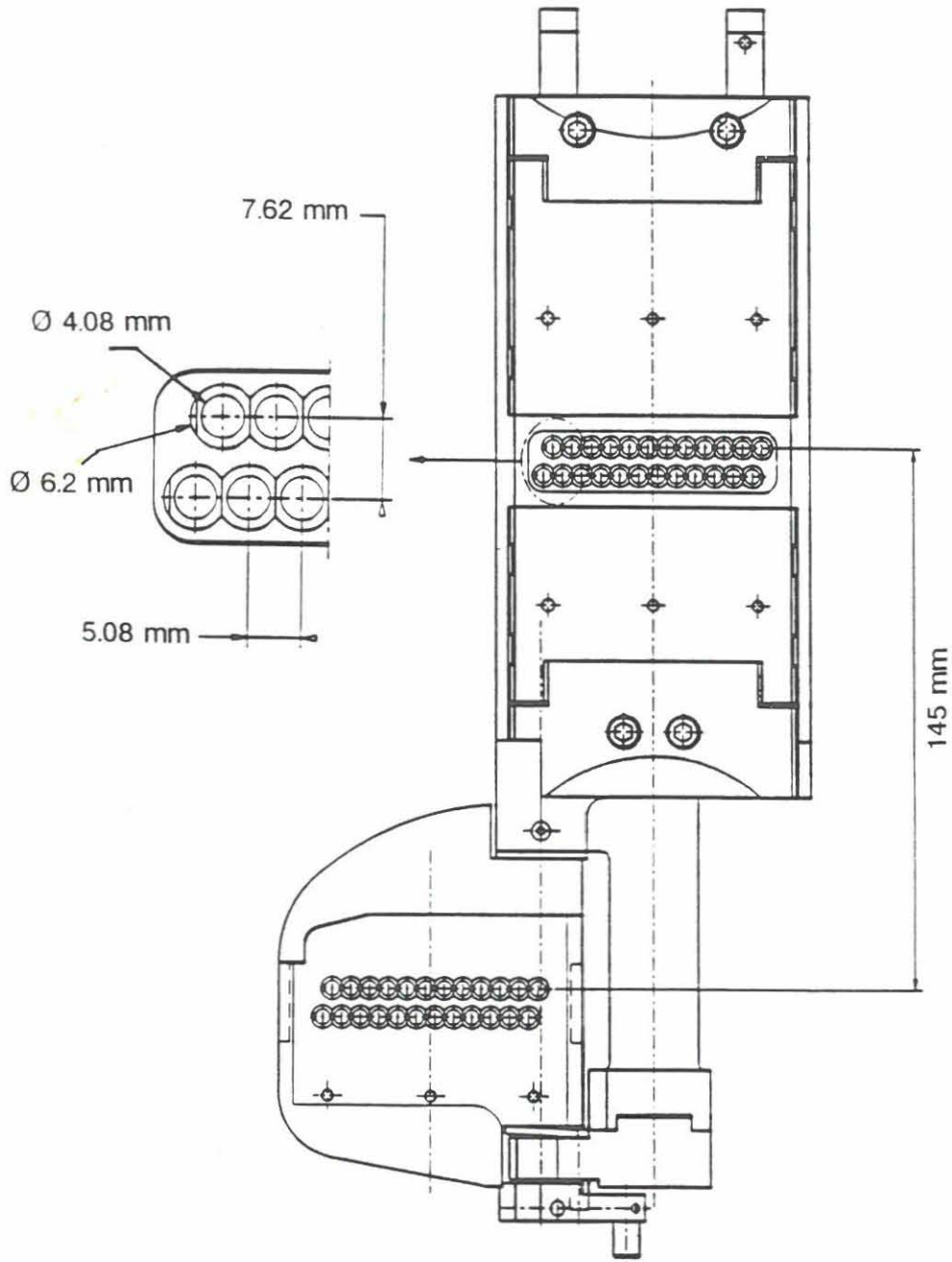

Fig. 16

FMI* PAD/FLAP CONFIGURATION



Four-Pad Tool

2 x 24 Button Electrodes per Pad/Flap

Schlumberger

* Mark of Schlumberger

Fig. 17

Formation Microlmager (FMI)*

Tool specifications

Make-up length	316 in. (8.02 m)	
Weight	465 lbm (211 kg)	
Closing Diameter	5 in. (127 mm)	
Number of sensors	192	
Number of pads/flaps	8	
Acquisition system	MAXIS 500	
Telemetry	DTS only	
Logging speed	Maximum	Recommended
Full-image mode	1800 ft/hr	1500 ft/hr
Four-pad mode	3600 ft/hr	2500 ft/hr
Dipmeter mode	5400 ft/hr	3000 ft/hr
Minimum hole size	6 1/4 in. (158 mm)	
Maximum hole size	21 in. (533 mm)	
Coverage		
Full-image mode	80% in 8-in. hole	
Four-pad mode	40% in 8-in. hole	
Maximum well deviation	90° with flex joint	
Maximum mud resistivity	50 ohm.m	
Pressure rating	20 000 psi (1400 bar)	
Temperature rating	350 °F (175 °C)	
Compatibility with other tools	ARI, AIT, GR, AMS (FMI must be lowest tool in string)	

Fig. 18

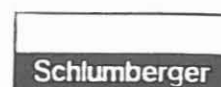

* Mark of Schlumberger

Formation Microlmager (FMI)*

Benefits

Addition of flap electrodes to Formation MicroScanner concept increases wall coverage by 100%

Decrease of button electrode size improves vertical resolution

Integration of orientation/inclination section in sonde reduces overall length of tool

Combinability with other MAXIS 500 tools reduces trips for logging

Multiple logging modes: Full-image mode
Four pad mode
Dipmeter mode

Applications

Structural analysis

Enhanced texture analysis

Characterization of sedimentary bodies

Net-to-gross ratio in sand/shale sequences

Fracture network evaluation

Secondary porosity evaluation

Deth-matching and post-orientation of cores

Reservoir characterization

Detection of permeability barriers

Determination of paleo-current direction

Thin bed analysis

Fig. 19

Azimuthal Resistivity Imager (ARI) *

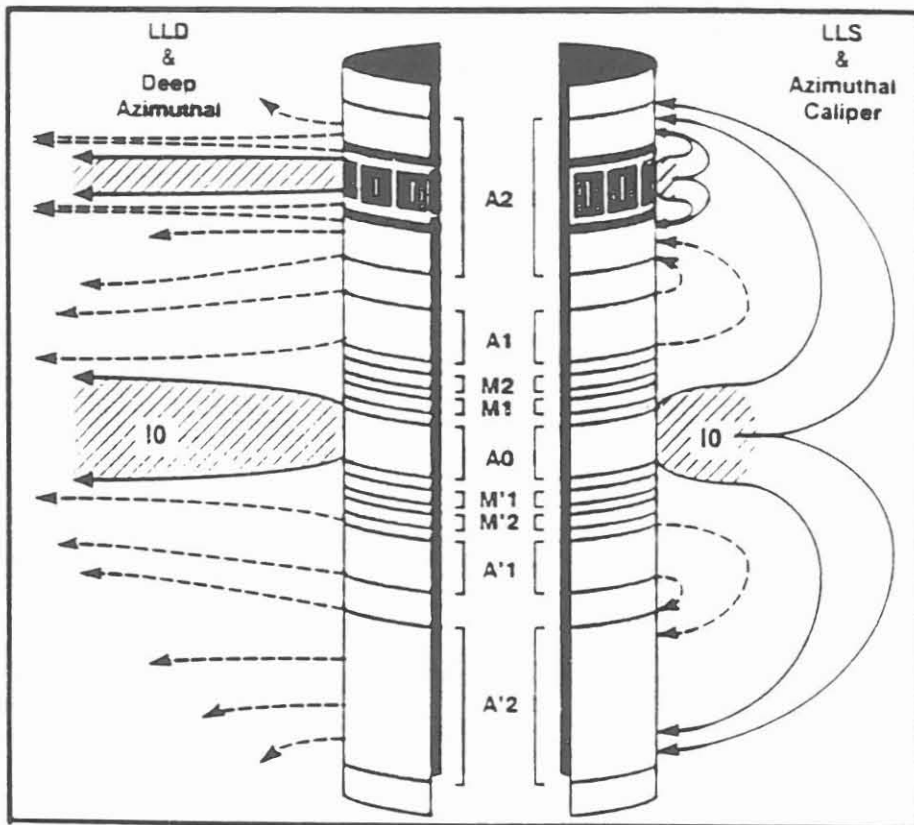

- 12 Electrode array located on two identical half shells
- Measures current from an electrode and takes potential difference between monitor electrodes and a remote reference
- Azimuthal and high resolution function in deep mode only (35 hz)
- 12 shallow resistivity measurements at 64khz

Fig. 20

* Mark of Schlumberger

Azimuthal Resistivity Imager (ARI)* Tool Specifications

Logging speed	3 600 ft/hr for 1" Az./h.r. sampling 7 200 ft/hr for DLL only operation
Operating temperature	-15°F to 350°F (-25°C to 175°C)
Operating pressure	20 000 psi (1 400 bars)
Min. borehole diameter	4 1/2" (11.4 cm)
Max. borehole diameter	12 1/4" (311.2 cm) opt. performance 21" (533.4 cm) operation
Operating limitations	Conductive muds only, up to 1.5 ohm.m 5 ohm.m for passive mode
Tool length	33 ft (10.05 m)
Tool diameter	
normal sonde	3 5/8" (9.2 cm)
medium subs	6" (15.2 cm), 7 1/4" (18.4 cm) with standoffs
Tool weight	528 lbm (240 kg)
Telemetry	
compatibility	DTS (with DTB "through wiring")
Combinability	Anywhere in DST tool string GPIT needed for orientation with FBST, the FBCC acts as A2
Combinability	
limitations	Bridle (BRT) mandatory AH 169 needed below Incompatible with MEST, SHDT, HDT (tools with housing shorted to "10")
Resistivity range	0.2 - 40 000 ohm.m
Instrument accuracy	5% ($1 < R_a < 2\,000$) 10% ($.2 < R_a < 5\,000$) 20% ($5\,000 < R_a < 40\,000$)
Vertical resolution	6 - 8 "
Azimuthal resolution	60 deg. fractures for 1" standoffs

* Mark of Schlumberger

Fig. 21

Azimuthal Resistivity Imager (ARI) *

APPLICATIONS

- **Fracture evaluation**
 - stand-alone -> detection, orientation of deep fractures
 - with FMS/FMI -> quantitative evaluation of aperture and extent

- **Higher vertical resolution**
better Rt estimation, especially in thin beds

- **Corrected resistivity**
 - for Groningen effect
 - fractures (Rt of host medium)
 - dip
 - tool eccentricity, irregular hole

- **Structural dip**

- **Rt estimation in horizontal well**

- **Nearby beds in horizontal wells**
bed distance up to 4 ft from borehole

Fig. 22

* Mark of Schlumberger

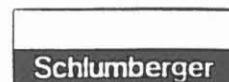

Ultrasonic Borehole Imager (UBI) *

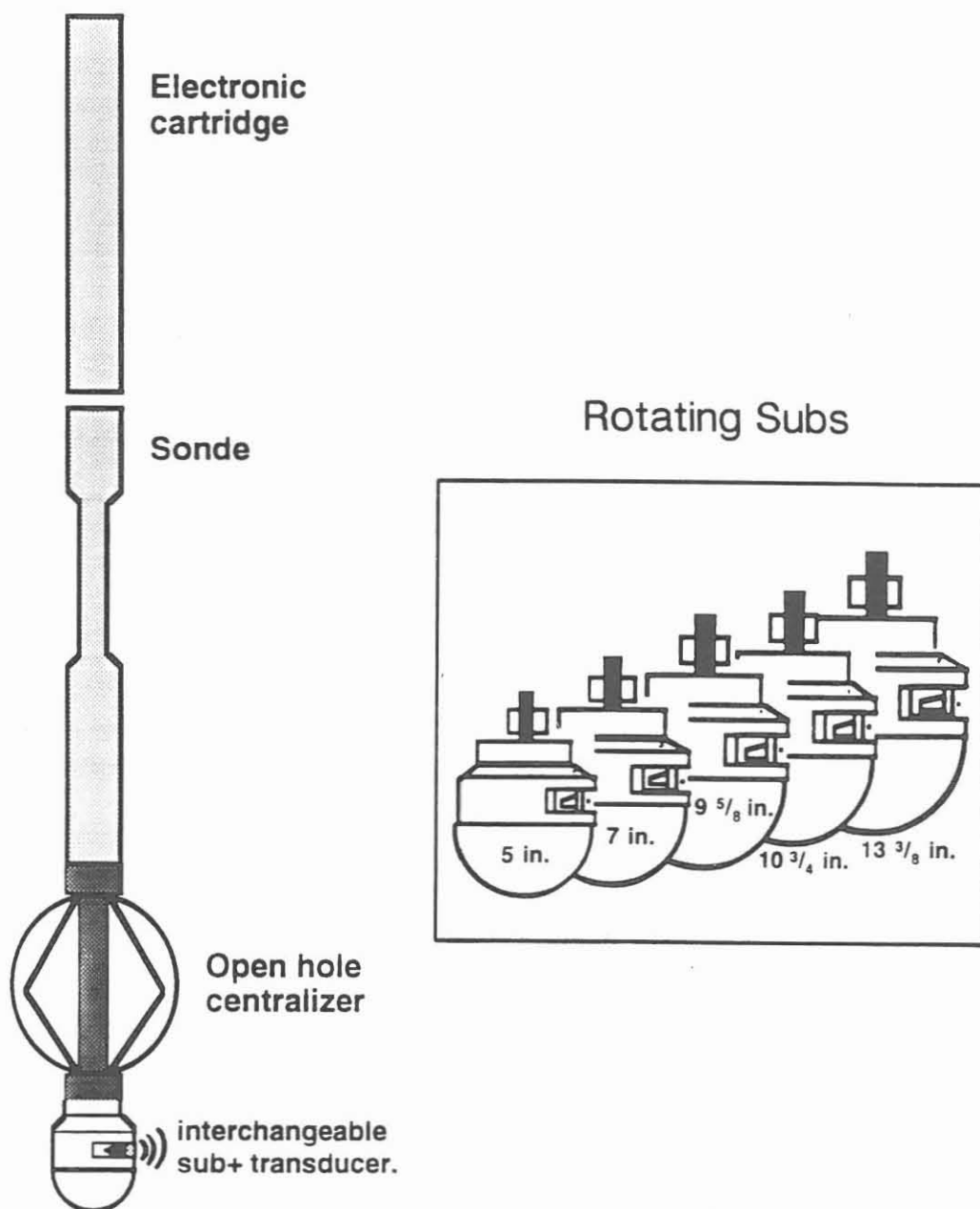
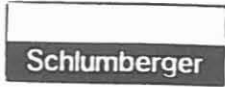

Fig. 23

* Mark of Schlumberger



Ultrasonic Borehole Imager (UBI) *

Specifications

General.

- tool length : 262.2 inch
- tool weight : 377.6 lbs
(with 7 inch. sub.)
- tool diameter : 3 3/8 inch.
(without sub.)

Environmental.

- temperature : 175 degC
- pressure : 20.000 psi.
- min.hole size : 5.5 inch.
- max.hole size : 12.5 inch.
- deviation : no limit.
- mud attenuation : < 12 db/cm/Mhz.
- approx.density : 1.9 gr/cc water base
1.4 gr/cc oil base.

- Combination** : gamma ray, inclinometer
(from top only) and other standard open-hole tools.

Fig. 24

Ultrasonic Borehole Imager (UBI) *

Logging modes.

	High resolution.	Low resolution
transducer freq.	500 khz	250 khz
acoustic beam (in water)	4.3 mm (.17 in.)	8.6 mm(.34 in.)
azimuthal sampling	180 pts/rtn.	140 pts/rtn.
vertical sampling	0.2 in.	0.4 in.

Measurements.

Amplitude:

- dynamics : 80 db.
- resolution : 0.05 db (0.6% full scale)

Radius (in clear fluid):

- resolution : 0.150 mm @ 250 khz.
: 0.075 mm @ 500 khz.
- absolute accuracy : +/- 3 mm.

Fig. 25

Example: FMS* - ARI* - UBI*

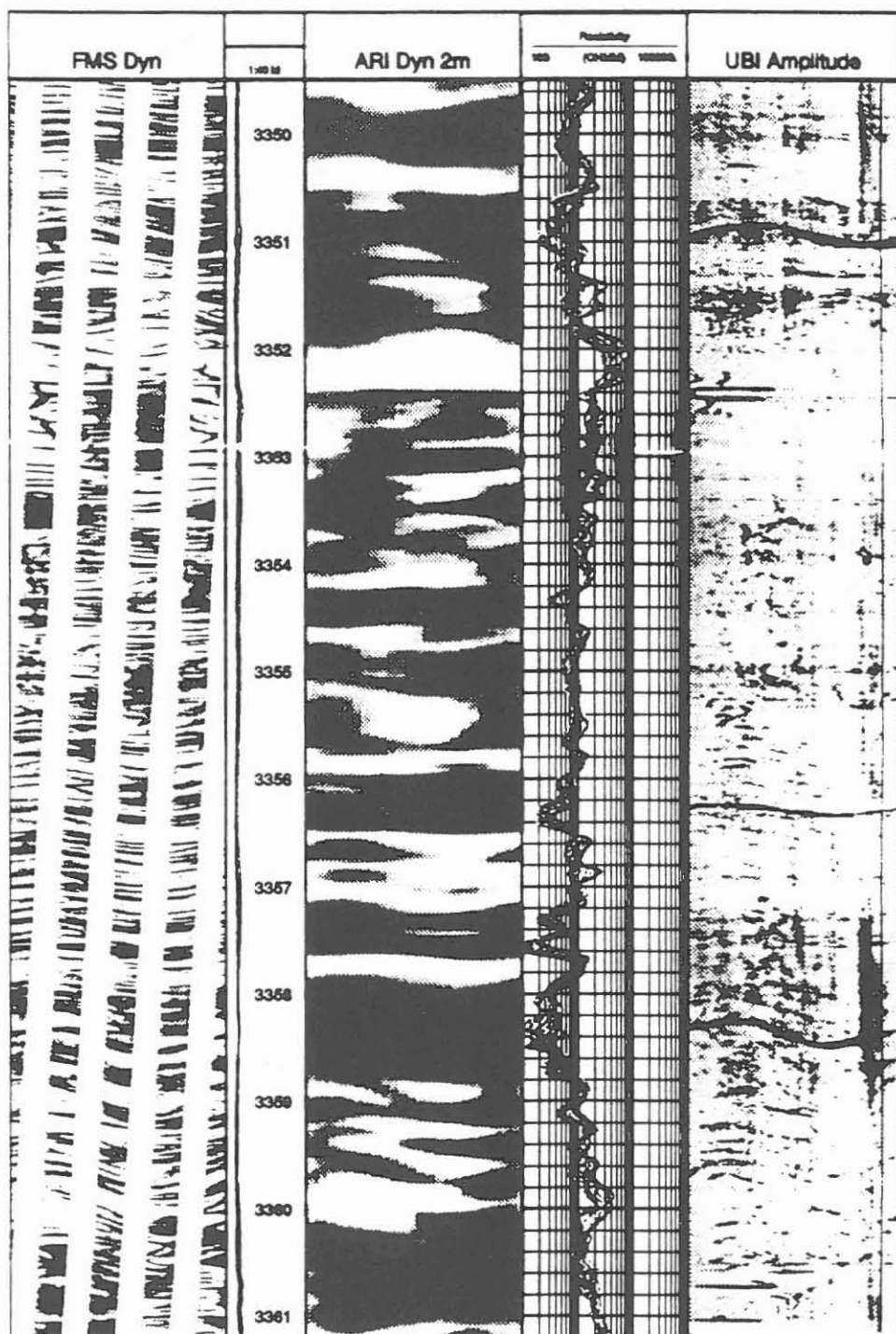
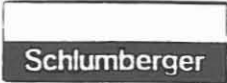
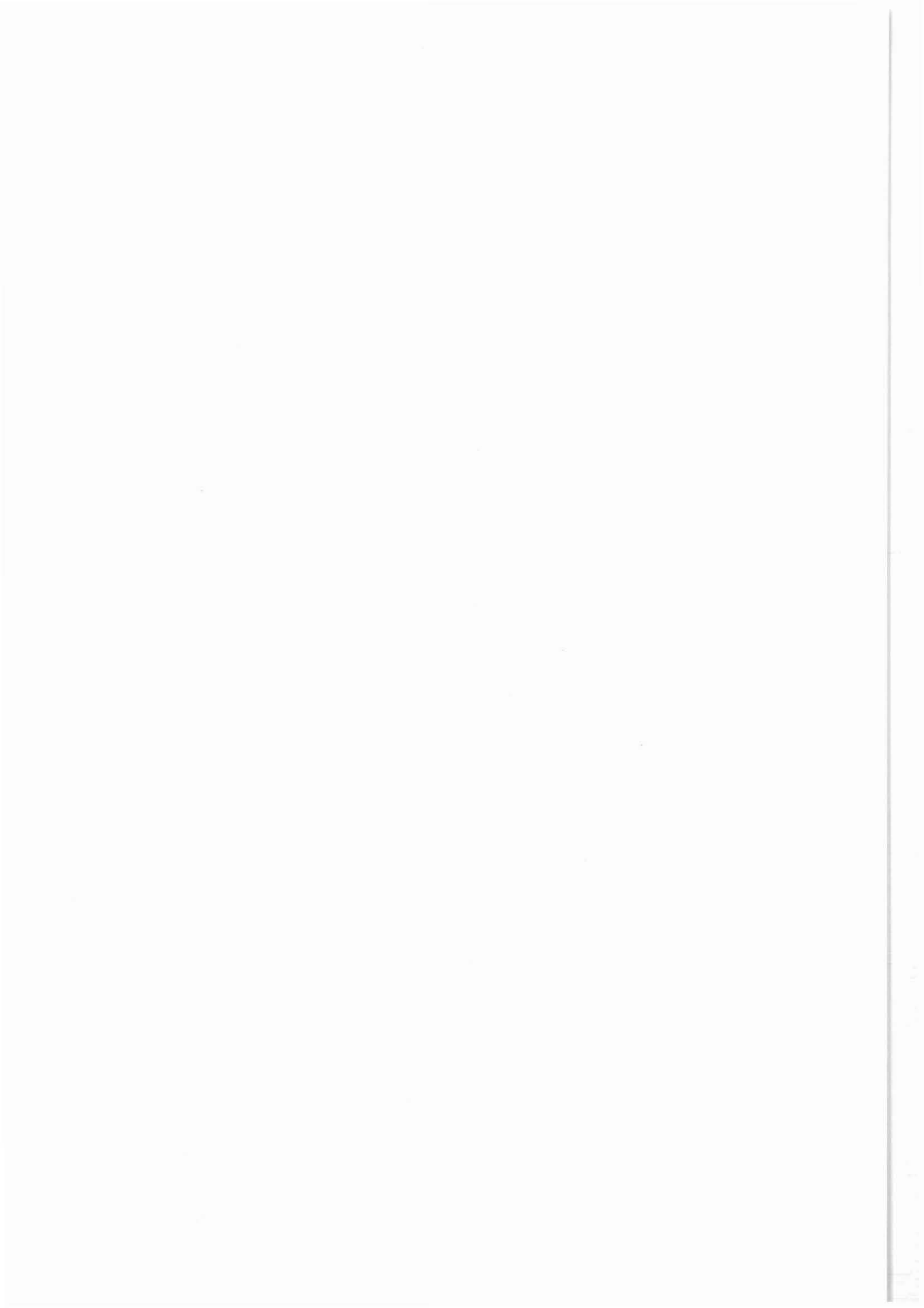

Fig. 26

* Mark of Schlumberger





Subsurface data acquisition for science by downhole measurements

P. Kehrler et al.

Geological Survey of Lower Saxony
KTB-Project Management
Stilleweg 2
30669 Hannover / Germany

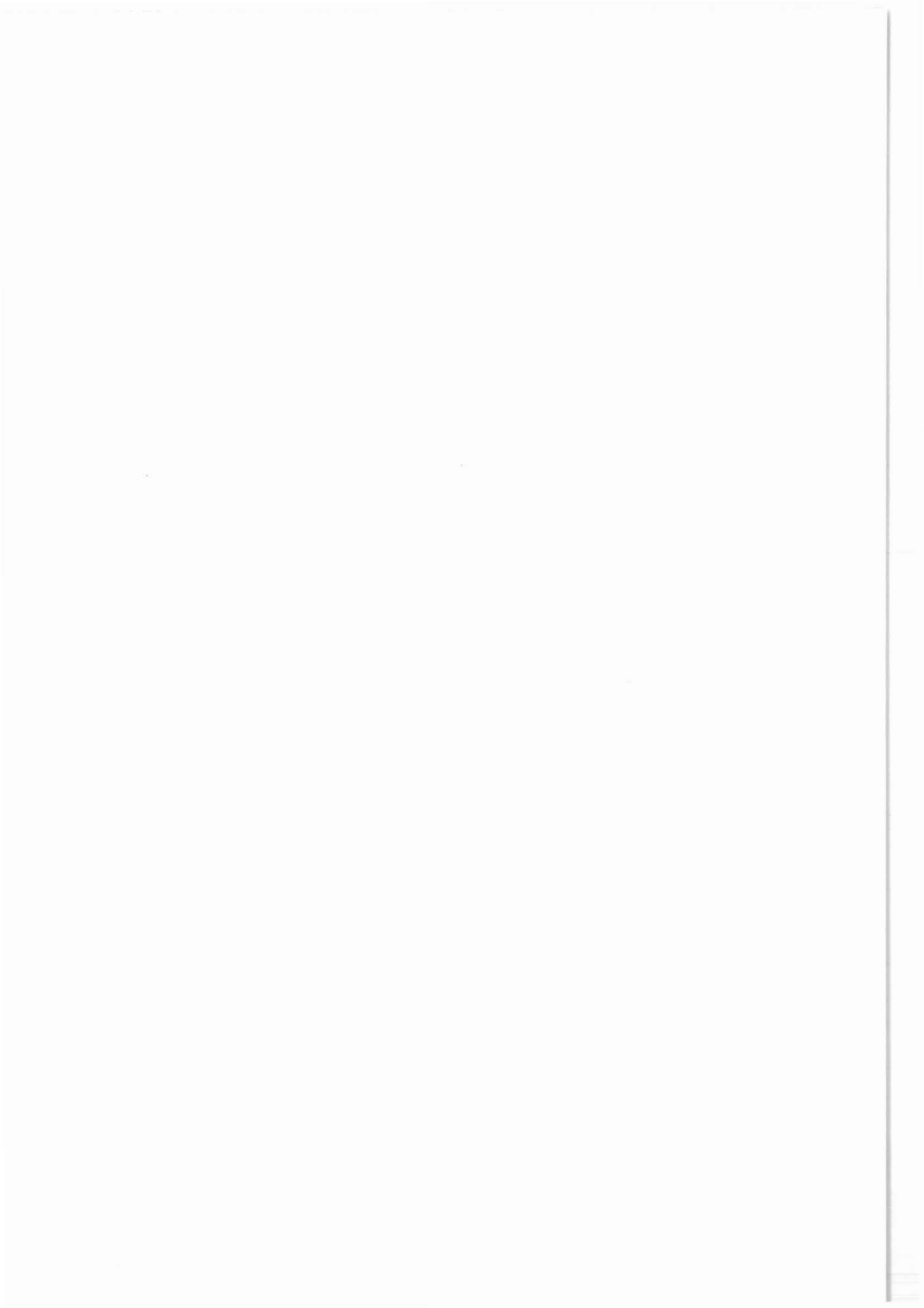

SUBSURFACE DATA ACQUISITION FOR SCIENCE BY DOWNHOLE MEASUREMENTS

- Overview, Experiences, Scientific Benefits-

K.BRAM, J.DRAXLER, P.KEHRER, J.KÜCK, W.KESSELS & G.ZOTH

1. INTRODUCTION

Applying downhole measurements in boreholes drilled for scientific targets requires a number of considerations and evaluations: scientific benefits, competition with other scientific measurement systems (e.g. laboratory), budget and rig time (both are closely related), risk to the borehole, tool availability, interest and free capacities in research groups for interpretation and interdisciplinary approach to the data as well as R&D lead time when further or new tool development is necessary.

Downhole measurements within a scientific project have to fit into the overall data acquisition concept. For example in the German Deep Drilling Project KTB the criteria for data acquisition is as follows: to define on the basis of the geoscientific objectives which parameters should be determined how, where and with what precision, considering the two main data sources, which are downhole and surface measurements. Objectives of an ambitious scientific drilling project like KTB require high quality scientific and technical data. To achieve this goal a number of new advanced technologies had to be developed in wireline logging, Measurement While Drilling (MWD), mud logging, sampling, laboratory equipment and analytical methods as well as data handling.

2. DOWNHOLE MEASUREMENT SYSTEMS

A broad variety of systems to measure in a borehole is existing either offered from commercial service companies, mainly with the oil and gas industry, or special tools developed for scientific purposes by universities and other research institutes. Methods for downhole measurements are for example Wireline Logging, Coiled Tubing resp. Drillpipe Conveyed Logging or Tough Logging Conditions (TLC), Measurement While Drilling (MWD) and Logging While Drilling (LWD), Testing and Fluid Sampling, Borehole Seismics, Experiments and Borehole Observatories for longterm measurements. Details about these measurement systems are given in the presentations by DRAXLER & BRAM as well as BOYELDIEU and LYSNE within the Working Group No.12 of the International Conference on Scientific Drilling at Potsdam, August 30 - September 1, 1993, published in this Report.

3. SCIENTIFIC BENEFITS

If one wants to evaluate the benefits of downhole measurements for scientific drilling projects one has to consider various factors: scientific objectives, data requirement and parameter selection to meet these objectives, evaluation if surface measurements of samples or downhole measurements respectively a combination of both are the most effective way to contribute to the scientific goals, selection and availability of tools, possibilities of processing and interpretation of data. Often after long periods only may a final scientific evaluation give answer to the real value of such measurements for solving scientific problems.

In selecting the right measurement systems it is important to realize that certain parameters can only be measured downhole. There is a number of parameters however which can be measured on the surface as well as downhole. For example petrology, mineralogy and fluid inclusions as well as

geochronology can only be done on samples at the surface laboratories, while stress field, fluid movements, tectonics, geochemistry, lithostratigraphy and physical parameters can be dealt with on surface and downhole. On the other hand physical fields, fractures, hydraulics and borehole geometry can only be measured under quasi in situ conditions in the hole.

4. INFRASTRUCTURE

The infrastructure necessary for downhole measurements in relation to scientific purposes varies considerably. For conventional boreholes (shallow, intermediate, deep) regular commercial equipment available from service companies and possibly some special tools from research institutes and universities, developed for measuring parameters usually without interest in commercial operations, might be sufficient.

However in superdeep boreholes like Kola SG 3 in Russia and KTB in Germany much more complicated and expensive infrastructure is necessary. This refers to high temperature and high pressure tools which have to be especially developed by industry and research institutes as well as to special cable and winch technologies. Extensive research and development with a lead time in the range of several years has to be performed in tool developments and logging unit design.

For example in the KTB-project a permanent Logging Center was installed due to the long range of the project (Fig.1). It contains the logging unit itself with winch and computer facilities for data acquisition and first steps of processing, special mechanical and electrical workshops for on site repairs of logging tools, special computers for further processing as well as offices and conference rooms. These serve for the staff permanently stationed at the well location as well as for researchers and engineers being there for limited times in relation to special experiments and measurements.

From the logging unit the cable runs to the rig via a tunnel due to safety considerations. Close to the rig a special built capstan (friction winch) drives the cable since the well has reached 6000 m because a normal winch is unable to handle the pulling of the cable (Fig.2). Within the rig a special installation for cable guidance saves expensive rig time. The tools can be already prepared while drilling operations are still going on. After the hole is declared ready for logging a retractable arm with the top sheave wheel is moved over and logging operations can immediately begin (Fig.3). By this way a considerable amount of expensive rig time can be saved over the many years of a longterm operation.

Special cable technologies are necessary for logging at great depth. For KTB a cable configuration and spooling system in three succeeding steps were developed (Fig.4). For phase 1 from 0 to 7000m a standard 7-conductor logging cable with an OD of 0,46 inch (11,7 mm) and a temperature rating of 190°C was used, also regular winch with floor and top sheave wheel. In phase 2 - 0 to 8500m- in addition to the standard winch a capstan was added and a special built 7-conductor combi-cable (7-52NVA) with a length of 9100m was used for logging, of which 5000m with a max. temperature of 190°C and the lower 4100m with a max. temperature rating of 230 °C, OD 0,52 inch (13,2mm). In phase 3 which was designed for a max. logging depth of 11000m a split cable configuration with a second winch was used. First a 4000m 7-conductor cable for a max. temperature of 320°C (7-39TFE) and an OD of 0,39 inch (9,9mm) was lowered with the second winch, hooked to the 9100m cable of phase 2 from the first drum and then the split cable is run into the hole with first winch and capstan (Fig.5). If temperatures would have exceeded the 320°C a mineral isolated 4-conductor cable for a max. temperature of 400°C (BICC MTC4T30) would have been applied, a special cable head was developed through KTB, however it was not necessary to operate this cable in the borehole.

The three different cable configurations (phase 1 to 3) have been successfully applied for logging the KTB-superdeep borehole from 1990 to 1994. There has been no accident in spite of sometimes difficult borehole situations due to instabilities of the rocks. No logging tools were lost in the total of 266 logging runs performed in this borehole, no fishing runs for tools or cable were necessary. The maximum logging depth was 9085m.

A number of new logging tools were developed by industry, universities and research institutes as well as by the KTB project management group in cooperation with logging service companies. The so called „KTB-Combi Sonde“ integrates several logging tools to save time in downhole measurements: cable head, telemetry, AMS (mud resistivity, head tension, temperature), gamma ray (GR), BGL (caliper, azimuth, deviation), SP (self potential) and temperature (Fig.6). This sonde combination of several tools was developed together with Schlumberger and in its final stage had a temperature rating of 200°C. A great number of logging runs were carried out with this tool and their results were an essential contribution to the scientific and technical evaluation of the borehole at any given time.

A special tool string for temperatures up to 260°C was developed by Schlumberger for KTB and was used for logging the lowermost parts of the superdeep borehole. It combined FMS (Formation Micro Scanner), BGL (borehole geometry with caliper, deviation and azimuth), AMS (mud resistivity, head tension and temperature), GR (gamma ray) and a CTS telemetry. This tool belongs to the group of so called HEL-tools (Hostile Environment Logging) which means that they have temperature ratings higher than the standard of 175°C.

A number of new logging tools developed in the service industry were tested in the KTB-boreholes - the pilot hole and the main hole -, some still as prototypes in development: FMS/FMI (Formation Micro Scanner/Formation Micro Imager), BHTV (Borehole Televiwer, GLT (Geochemical Logging Tool, MSCT (Mechanical Sidewall Coring Tool), ALAT (Azimuthal Laterolog, FS Leutert (Fluid Sampler) and DSI (Dipole Sonic Imaging Tool).

In the KTB R&D program for logging tools also universities and other research institutes were active in developing tools for special purposes not available from industry. These include FML (Fluxgate Magnetometer, University of Braunschweig), MS (Magnetic Susceptibility, University of München), IP (Induced Polarisation, Niedersächsisches Landesamt für Bodenforschung and Etvos Lorant Geophysical Institute, Budapest, Hungary), BHTV (Borehole Televiwer, Deutsche Montan Technologie), HCT (Heat Conductivity, Technical University Berlin) and SP (Self Potential/Redox, University of Frankfurt).

In total it can be said that the R&D program of the KTB project management group which initiated and pushed developments of all kinds of downhole tools - together with industry, universities and research institutes - was quite successful and by this way high quality scientific and technical data could be collected which were an essential contribution to reaching the objectives of the KTB-project.

5. BUDGET CONSIDERATIONS

The KTB-project had a total budget of 528 million German Marks from 1982 to 1994. An analysis shows that about 13% of this amount were spent on the operative scientific program on the drilling site which includes sampling, field laboratory, logging, logging center and data processing in the drilling period from 1987 to 1994 (pilot and main borehole). A time and cost analysis of the pilot hole results in 10% of budget for logging and testing and 13% of rig time. Two different scenarios of the time planning of the superdeep borehole resulted both in 10% rig time for logging and testing. However after four years of drilling from 1990 to 1994 with a reached depth of 9101m a total of 6% rig time had only been used. Reasons are difficult hole conditions, drilling problems and consequently more drilling time than planned and general budget problems. The R&D program of KTB - drilling and logging developments - was 7% of total KTB budget.

6. CONCLUSIONS

A wide variety of downhole measurements for scientific purposes is existing for conventional depths, however only to a very limited extent for hostile environment conditions. Downhole measurements are considered one of the principal data sources for solving geoscientific objectives. The decision of

applying downhole measurements depends on scientific benefits, must be seen in relation to other data sources (e.g. laboratory), competes with other scientific methods and must be evaluated in relation to budget and risk to the borehole

Measuring downhole and acquiring big quantities of high quality data is one thing, but to find research groups for interpretation of data, especially interdisciplinary, is much more difficult to achieve. Evaluating economics in basic science projects like scientific drilling is extremely difficult. Approx. 10% of budget resp. rig time must be calculated. The budget is always insufficient in relation to scientific demands. R&D is expensive and demands lead time. There are also failures in technical developments - not every R&D project results in a success.

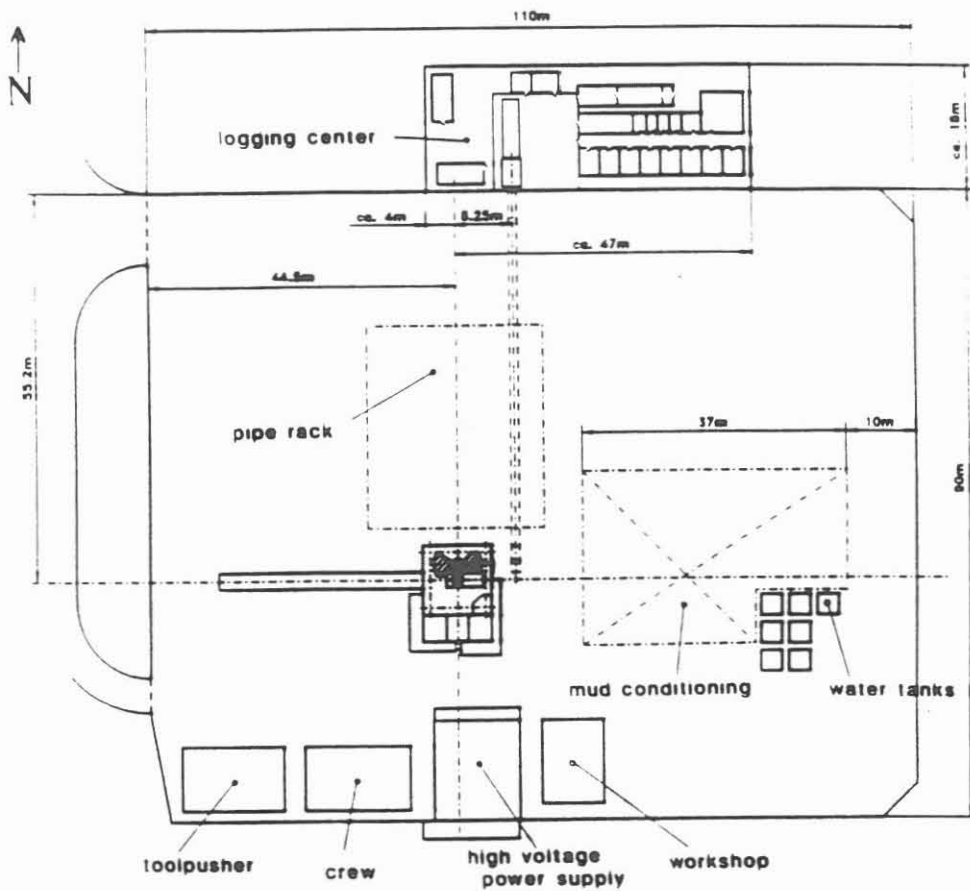
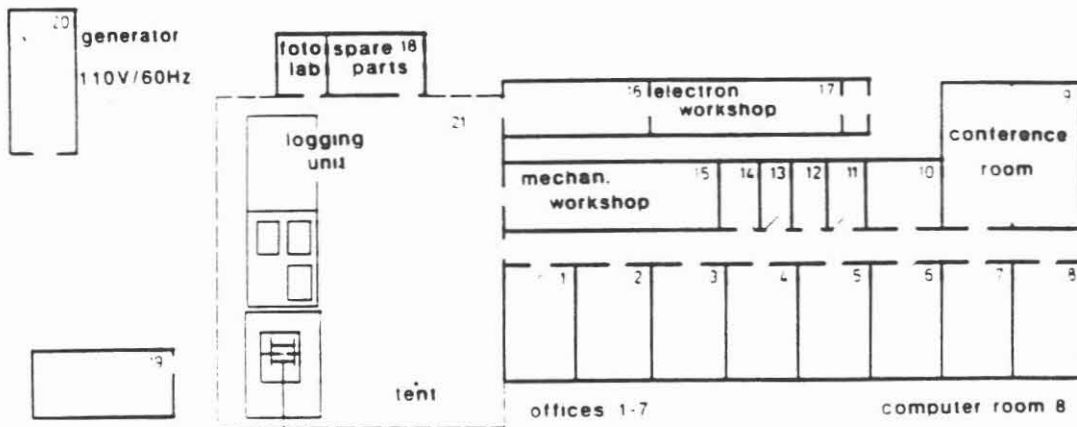

Fig.2.1: Overview, installation of drilling location



Overview, logging center

FIG. 1

KTB - Logging Center
 installed at drill site KTB-Oberpfalz HB

KTB

FIG. 2

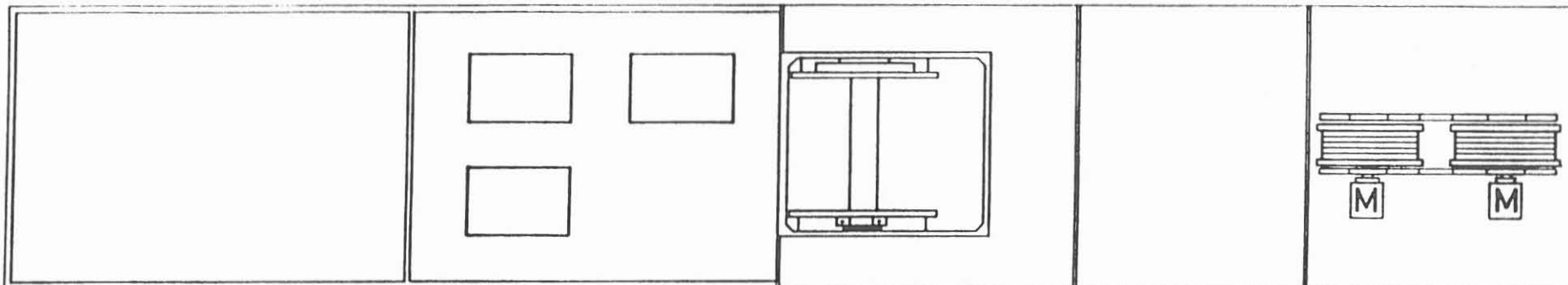

Winch drive
diesel hydraulic (107 kW)

Cable capacity
7500 m/15000 m, 7-wire, 11.9 ϕ

Sound proofing
40 db - 100 m dist.

Cable speed
0.5 - 275 m min⁻¹

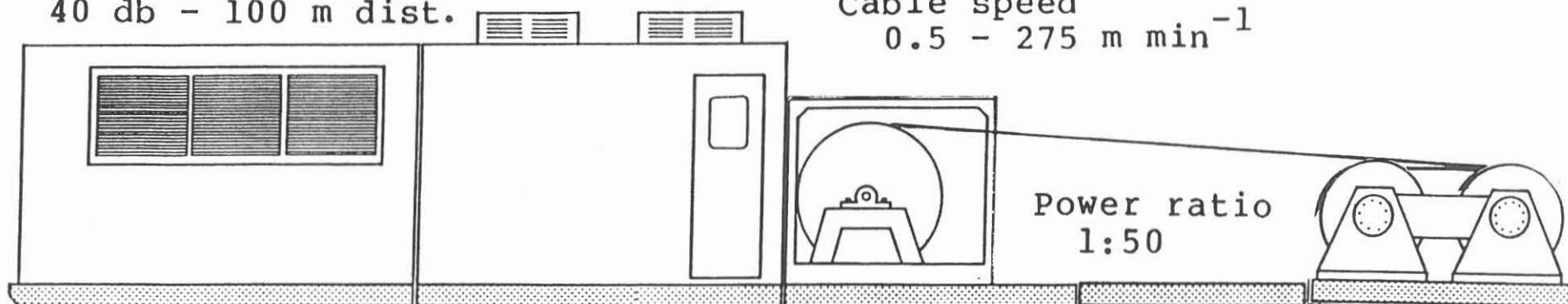

Power Cab

Data
Acquisition

Winch

Power ratio
1:50

Capstan

INTERNATIONAL CONFERENCE ON SCIENTIFIC DRILLING
POTSDAM, 30.08 - 01.09.93

KTB

Niedersächsisches Landesamt für Bodenforschung

FIG. 3

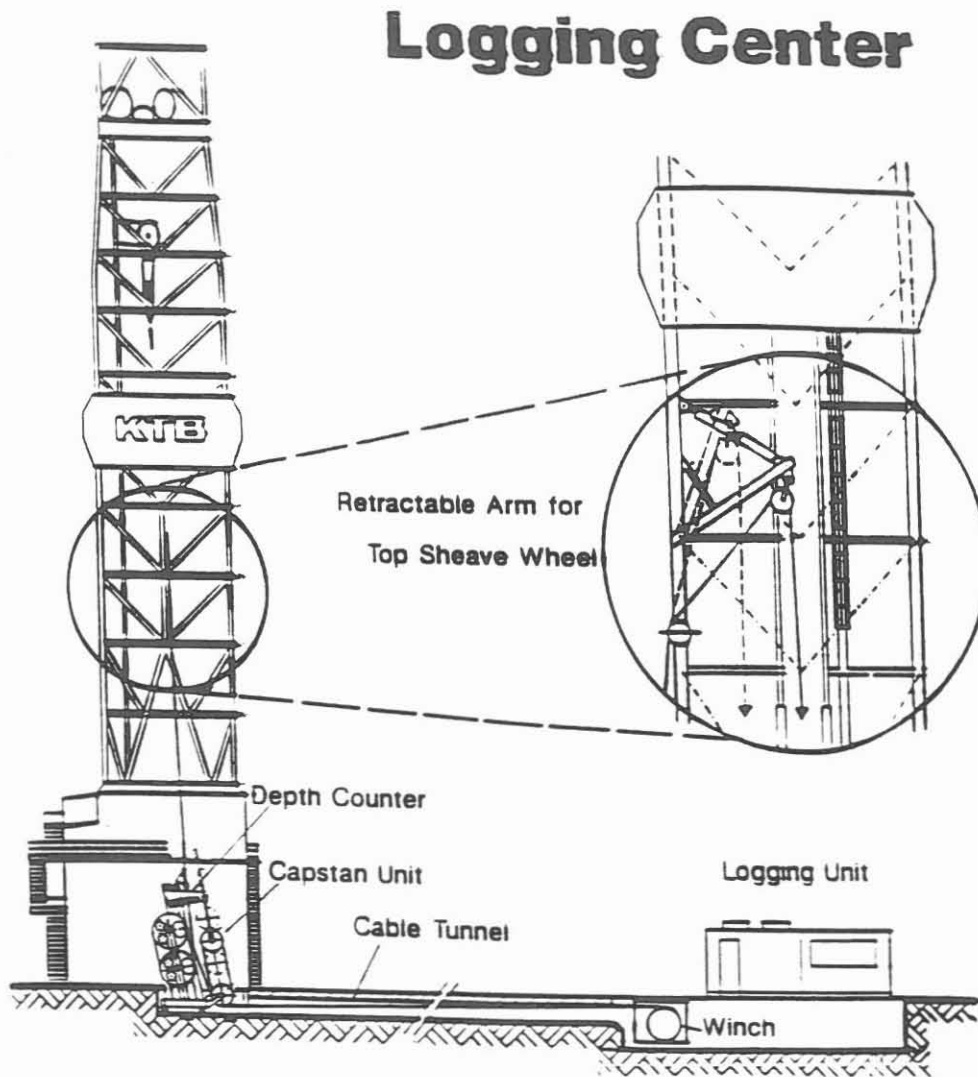

KTB - Logging System Installation for Cable Guidance

INTERNATIONAL CONFERENCE ON SCIENTIFIC DRILLING
POTSDAM, 30.08 - 01.09.93

KTB

FIG. 4

Cable Configuration and Spooling System for KTB-Deep Hole Logging

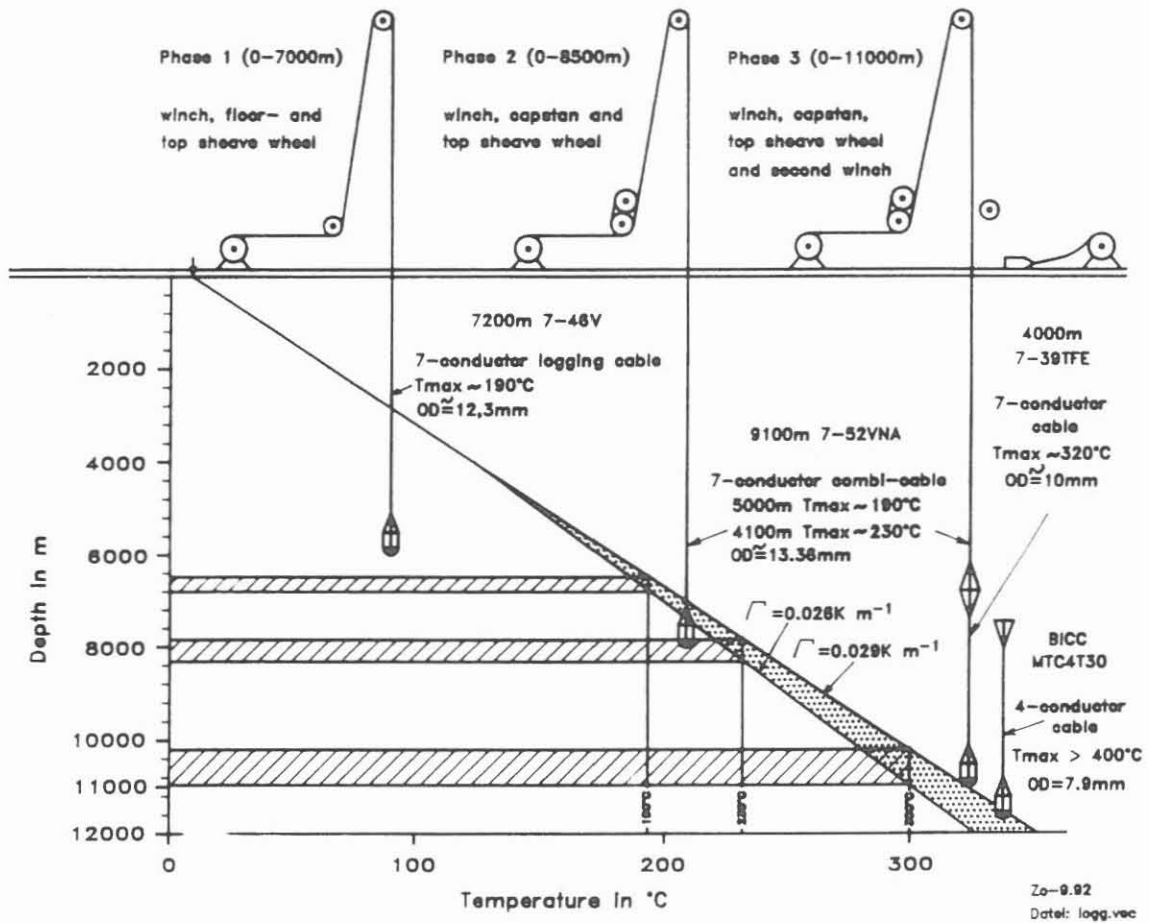

FIG. 5

Handling with two Cables

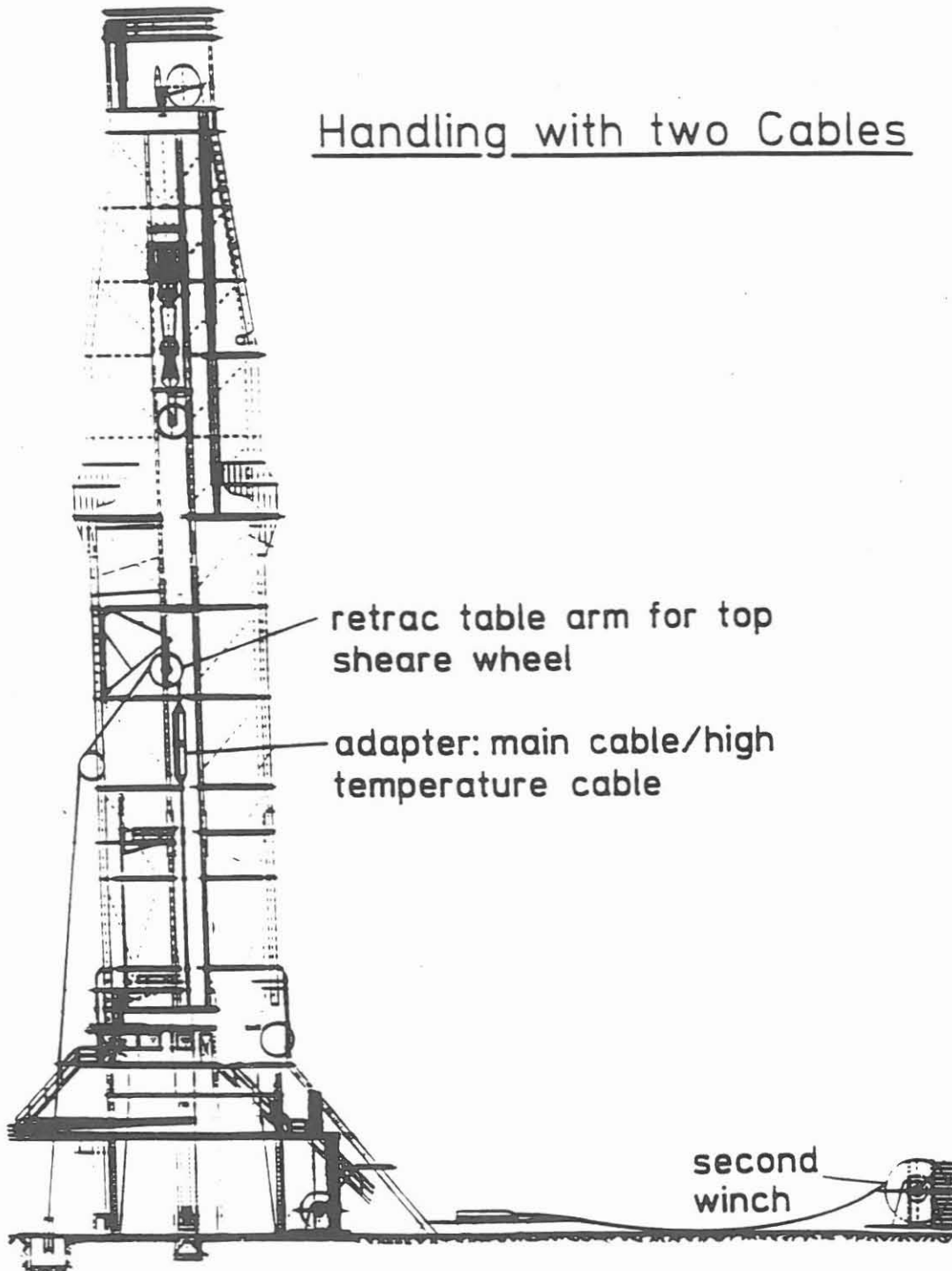
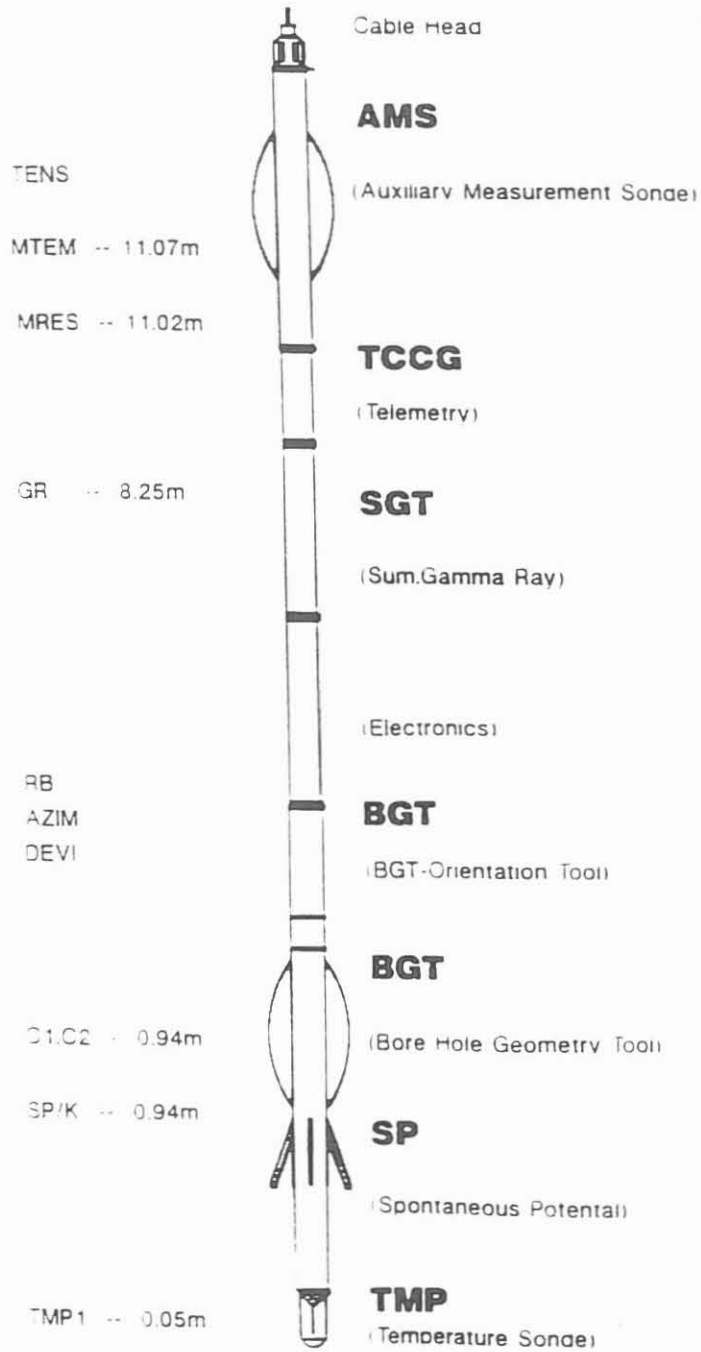

FIG. 6

KTB - Combi-Sonde



Evolution of downhole measurement systems

P. Lysne

Geoscience Research Drilling Office
Sandia National Laboratories
Albuquerque, NM 87185 / USA

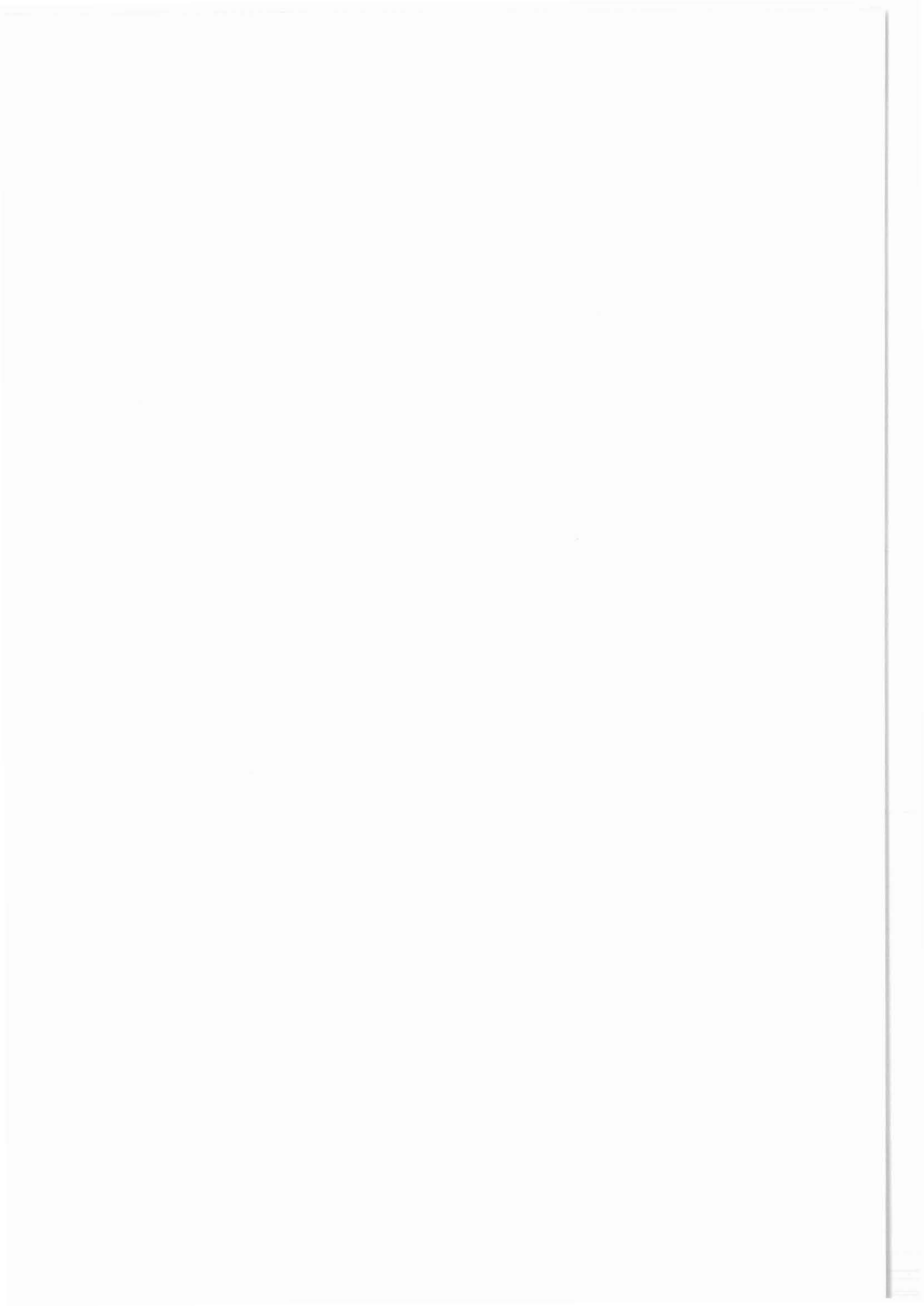

EVOLUTION OF DOWNHOLE MEASUREMENT SYSTEMS

Peter Lysne
Geoscience Research Drilling Office
Sandia National Laboratories
Albuquerque, NM 87185

ABSTRACT

An often-cited example of the need for the development of downhole tools arises from the lack of tools suitable for use in thermal regimes. But a more general reason for development stems from the nature of scientific drilling in that work is conducted in regions of the Earth's crust that differ from the sedimentary regions of interest to the traditional logging industry. Thus, even well-established tools must be examined for data integrity and information content. Interactions with industrial institutions can further this mission at a time when budgetary difficulties are manifest. Industrial interactions will require guarantees that evolutionary systems are useful and practical; guidelines addressing such quality issues are under development within the Ocean Drilling Program.

INTRODUCTION

Thrusts in the geosciences are placing an ever-increasing demand on downhole measurement systems at a time when the potential for major strides forward are possible, but when contributions from the previously supportive hydrocarbon industry are almost non-existent.

The majority of downhole measurements used in scientific programs originated in the hydrocarbon industry where advances proceeded in a hand-over-hand fashion. The first documented measurements were made in 1927 when the Schlumberger brothers demonstrated that resistivity measurements could be used to make hole-to-hole correlations. Later, resistivity measurements were rendered quantitative when an empirical relation was established between the resistivity and porosity. Since porosity is of strategic importance, "Archie's Law" provided justification for the development of better downhole tools in the form of focused-electrode devices. But these better measurements revealed difficulties with Archie's interpretation, so shaley-sand models evolved. In turn, these models required input concerning clay content, and this need drove refinements in nuclear logging tools. This process of need-derived advancement continued until the severe depression of the hydrocarbon industry began in the early 1980s. Few advances in downhole measurements have occurred in the past decade even though technological achievements make them imminently feasible.

A transition in scientific thinking and energy strategies also occurred in the early 1980s. During this time, the Deep Sea Drilling Program was reborn as the Ocean Drilling Program, and strong continental drilling programs emerged in several countries. These programs moved away from the sedimentary basins of importance to the hydrocarbon industry, and soon it became apparent that common downhole tools and interpretive techniques were in need of modification. Concurrently, drilling into thermal regimes was initiated in the geothermal industry, and this drilling was advanced by several scientific endeavors. Unfortunately, the loose federation of geothermal and scientific interests was insufficient to sustain a thrust aimed at development of high-temperature tools. In fact, some advances made in the early 1980s have been lost due to an entrenchment of the high-temperature semiconductor industry. It is now apparent that funding constraints on scientific and industrial fronts are a major hurdle to understanding crustal matters, and that strong cooperative efforts must be initiated if momentum is to be gained.

The purpose of this paper is to assess downhole measurements as they pertain to scientific programs. First, the generic issue of tool response to borehole conditions is addressed because it pertains to all measurement systems. The paper then deals with the particular case of high-temperature tools because such tools are not available from the usual service companies. The next section puts forth the need for rules governing the development of tools, and presents the set of governing conditions that were recently adopted by the Ocean Drilling Program. Finally, a view to the future is made.

EVOLUTIONARY ISSUES

From the viewpoint of a logging specialist, physical properties fall into two categories: (1) primary properties that can be readily determined downhole, and (2) secondary properties that are of importance, but are difficult to measure directly using downhole instruments. The primary properties include quantities such as borehole shape, temperature, resistivity, sonic velocity, hydrogen content, and density. These properties often delineate quantities or features of interest, and they are used in hole-to-hole correlation. Furthermore, the resistivity, the sonic velocity, and the density are necessary to calibrate surface geophysical studies. Secondary properties include porosity, permeability, lithology, oxidation state, and water saturation. These quantities may be determined from core, but core may not be available if drilling conditions are bad, if industry holes of opportunity are exploited for scientific purposes, or if budgetary constraints are over-riding.

Foundations for the measurement of primary properties are based on the defining equations of classical physics, on a knowledge of proper boundary conditions for the solution of the ensuing partial differential equations, and on a model for the material properties of the media surrounding the sonde. The material model contains one or more adjustable parameters that represent quantities of the first category. The adjustable parameters are obtained through routines that fit measured quantities (voltages, time differences, count rates, etc.) to the model. To illustrate these concepts, appropriate

relations for four tools commonly used to determine porosity are listed in Table 1. Due to the importance of porosity to the hydrocarbon industry, resistivity, sonic, neutron, and gamma tools have received considerable attention in recent years. A cogent discussion of these and other tools has been published (Hearst and Nelson, 1985); a review of techniques used in scientific programs is also available (ODP, 1990).

The relevance of the material model plays an important role in evaluating a tool's response. For example, the response of resistivity tools usually is based on Ohm's Law, a linear relation between the electric field and the current density. This material model is proper as long as the formation is isotropic and homogeneous on a scale that is small compared to characteristic volumes introduced in the solution of the differential equations that govern a tool's response. Similarly, the neutron tool used to measure hydrogen content is accurate as long as the porosity, the water saturation, and the amount of material with large thermal neutron absorption properties is constant within each characteristic volume. Such information is best obtained from core, although complete core is not needed. This situation illustrates that core and logs are complementary systems, and they should be used together to provide information at a minimum cost.

In the past, the solution of differential equations governing tool responses was tedious, and often inexact due to the large characteristic volumes and symmetry constraints introduced to make the problem tractable. Thus, tools were calibrated using test pits designed to simulate the range of subsurface conditions that tools were expected to encounter. This approach leads to the "dolomite", "limestone", or "sandstone" calibrations that are applicable to sediments, but of uncertain applicability to other materials.

Recently, fast computers using modern finite-element and Monte Carlo algorithms have mitigated the problem of modeling a tool's response since both very small characteristic volumes and three-dimensional geometries are tractable. Now the cost of evaluating a tool's performance is far less than that encountered when test pits were a necessity. This means that the effect of variations in the material models can be thoroughly explored if knowledge of the interior workings of a tool are available. Unfortunately, some logging companies treat this information as proprietary. If cooperative companies cannot be found, re-development of an existing tool concept may be justified to insure a better understanding of tool responses.

Consider now the relations between primary and secondary properties. In principle, these relations are governed by the basic physics, and appropriate relations could be found by following paths similar to those discussed above. However, geometrical issues are very complex and occur on a size scale commensurate with pore dimensions. Even the best computational techniques cannot solve such detailed problems. Perhaps statistical techniques will provide solutions. For the present, a major difficulty arises because correlations between primary and secondary properties are uncertain and ambiguous.

Table 1 lists relations that have been used to tie primary properties to porosity. The ambiguity in these relations is emphasized by the over fifty variations of Archie's Law (a skeptic might note that Archie's Law is a linear fit on a log-log plot that implies no theoretical justification). Clearly, there is a need for a better fundamental understanding of relations between primary and secondary properties, and advances in the understanding of these relations will have a profound effect on both scientific and applied endeavors.

HIGH-TEMPERATURE TOOLS

The issues that confront the geothermal industry present an illustration of the principles discussed above. An often-cited obstacle to downhole measurements is that tools used in low-temperature formations are physically incompatible with the geothermal environment, and the cost of developing and maintaining a suitable tool suite exceeds the anticipated revenues from logging services. Since a service industry can only be supported if measurements produce output useful to its clients, and since interpretative techniques developed for hydrocarbon reservoirs are not proven in geothermal formations, a second obstacle is the general inability to relate log data to useful information. In some respects, the development of a viable geothermal logging industry is impeded by the chicken-egg syndrome. Scientific drilling programs can help overcome this impasse.

Hostile environment tools commonly found in the logging service industry are capable of operation up to 260 °C so they are applicable to some, but not all, high-temperature applications. Furthermore, size constraints are imposed by the diamond coring techniques that are commonly used in scientific and geothermal exploration programs. Taken together, the temperature and the tool diameter provide initial criteria for the design of logging equipment. Given present needs and realistic technologies, a modern tool will be operable at the critical point of sea water (407 °C, 289.5 bar), and it will be less than 50 mm in diameter so that it will fit through an "H" size coring bit and into an "N" size hole.

Conceptually, two classes of tools are able to meet these criteria. The first class utilizes a teflon (300 °C maximum) or magnesium-oxide-insulated electrical wireline to transmit power and data between the tool and the surface. The second class is completely self-contained in that power is obtained from batteries, and data are stored in a memory system. Even though memory tools have been around for decades, they have not found common usage due to past limitations. This situation is changing rapidly due to improvements in digital technology.

Both classes of tools were used to make high-resolution temperature measurements in the VC-2B scientific corehole to 295 °C, see Figure 1, and the results of this work had a major effect on the directions of tool development in the United States. While data were of equivalent quality, the tool using a teflon-insulated electric wireline failed about one-half of the time due to wireline or cable-head difficulties. Significantly, the memory tool has never experienced a data loss. This record includes the faithful recording of temperature excursions during fishing exercises made when the

tool was twice dropped through 2.5 km of internal upset drill pipe. The success rate, and the relatively low cost of memory tools has prompted the US Department of Energy and other US institutions to make a major thrust in their development.

While memory tools are inexpensive, logging scientists raise the issue that the memory concept is flawed by the lack of communication between the tool and the operator. The greatest concern is that a tool will fail, yet the logging run continue due to lack of information. Perhaps future tools will possess some means of communicating a failed condition to the surface. In any event, memory tools must possess reliability and quality to be credible.

In the same vein, logging strategies are often evolved on the basis of real-time data. Memory tools preclude this approach. This point is not as valid now as it was in the past since modern data-logging systems support languages that are "intelligent". Thus, a logging strategy that contains contingencies may be programmed into the tool. Finally, the power available in a battery operated tool is limited. This means that power-intensive measurements are constrained to short duration. Examples of instruments currently under development within the world community are: a precision pressure/temperature tool, a spectral gamma tool, a fluid sampler, a focused resistivity tool, and a fluid conductivity tool.

ODP GUIDELINES FOR SYSTEM DEVELOPMENT

The Ocean Drilling Program (ODP) and associated institutions have maintained a modest effort in tool development for nearly a decade. While a few tools have been successful and have moved on into the industrial sector, many have languished due to an underestimation of the development difficulty and cost. Furthermore, engineering deficiencies in these "Third-Party" tools have resulted in inordinate expenditures of ship's time for a limited data return. Thus, the ODP has adopted a set of guidelines for tool development (ODP, 1992).

A feature of the ODP plan is that a *Principal Investigator* must be identified, and that this individual is the primary proponent for the development and use of the tool. Among other issues, this investigator must submit a plan that identifies development milestones, that makes provisions for land testing, that specifies the usefulness of the proposed measurements, and that contains a statement that the tool would be available for post-development deployment in the ODP. It is most important to note that Principal Investigator is tasked with leading the development of a measurement system, not just a tool.

An ODP tool development program follows a prescribed course consisting of three stages. A *Development Tool* is either a tool that is under development externally for use in the ODP or a tool that has been developed outside the ODP for other purposes, and is being considered for ODP deployment. Unlike tools in more advanced stages of development, the scientific success of a cruise cannot depend on a Development Tool.

After the development stage, the tool attains the status of a *Certified Tool*, and it is available for scientific deployment. The request for certification includes cost estimates for routine operation including data processing, details concerning spare parts, operating and maintenance manuals, and a demonstration of the usefulness of the data.

Finally, a *Mature Tool* is an established tool that has become part of the ODP tool suite. Such a tool is effectively owned by the ODP.

The ODP guidelines for tool development are new and evolving. The tasks that are placed on the Principal Investigator are difficult, and require strong support from numerous scientific and engineering disciplines. This support will be costly. But the programmatic consequences of failed efforts are much more costly since failures stifle scientific innovation. It is not clear how the ODP will muster the necessary resources to support evolutionary efforts; it is clear that strong scientific rationale is necessary to justify their existence. The ODP, working through the entire JOIDES Panel structure, is forming a consensus regarding the evolution of downhole measurement systems. The resulting model will form the basis for a more general technology-development thrust that will influence all areas of the geological sciences.

CONCLUDING REMARKS

There is a clear need for new downhole measurement tools and interpretation techniques within the various scientific drilling programs. Furthermore, this need extends into institutions that are recovering resources from the crust, or using the crust as a repository for wastes. The depressed condition of the hydrocarbon industry precludes the strong advances that this sector offered to the science of downhole measurements in the past. However, the prevailing economic condition means that doors will be open for cooperation between the scientific and industrial institutions. It is proper and necessary for the scientific community to take advantage of the situation.

ACKNOWLEDGMENT

This work was supported by the US Department of Energy/Office of Basic Energy Sciences/Geoscience at Sandia National Laboratory under contract DE-AC04-76DP00789.

REFERENCES

Hearst, Joseph R., and Philip H. Nelson, 1985. "Well Logging for Physical Properties", McGraw-Hill Book Company.

Lysne, Peter, 1991. "Pressure, Volume, Temperature States within the VC-2B Corehole, Valles Caldera, New Mexico, USA", *Applied Geochemistry*, Vol. 6, pp. 665-670.

ODP, 1990. "Wireline Logging Manual", available from the Borehole Research Group, Lamont-Doherty Earth Observatory, Palisades, NY 10964.

ODP, 1992. "Revised Guidelines for Development of Third-Party Tools", *JOIDES Journal*. Vol. 18, No. 3, p. 37. The equivalent pamphlet, Guide to Third-Party Tools, is available from JOI, Inc., 1755 Massachusetts Avenue NW, Washington, DC 20036-2102.

FIGURE CAPTION

Temperature logs made in the VC-2B corehole, Valles Caldera, NM, USA. The log of May, 1990 was made shortly after circulation of drilling fluids was stopped, and it shows permeable zones of lost circulation that were candidates for fluid-sampling experiments. The insert illustrates the liquid-vapor interface after the fluid level in the hole had dropped to an equilibrium level, (Lysne, 1991).

TABLE 1. Resistivity, Sonic, Neutron, and Gamma Tools Commonly Used to Measure Porosity.

Underlying Physics	Bulk Material Model	Primary Property	Interpretive Model	Secondary Property
Maxwell's Eqs.	Ohm's Law	resistivity	Archie's Law	porosity
Newton's Eqs.	Hook's Law, density	sonic velocity	Wyllie's Law	porosity
Boltzmann's Eq.	elemental composition of matrix, $Z > 1$	hydrogen content	ratio, pore water to bound water	porosity
Boltzmann's Eq.	elemental composition of matrix	density	grain density	porosity

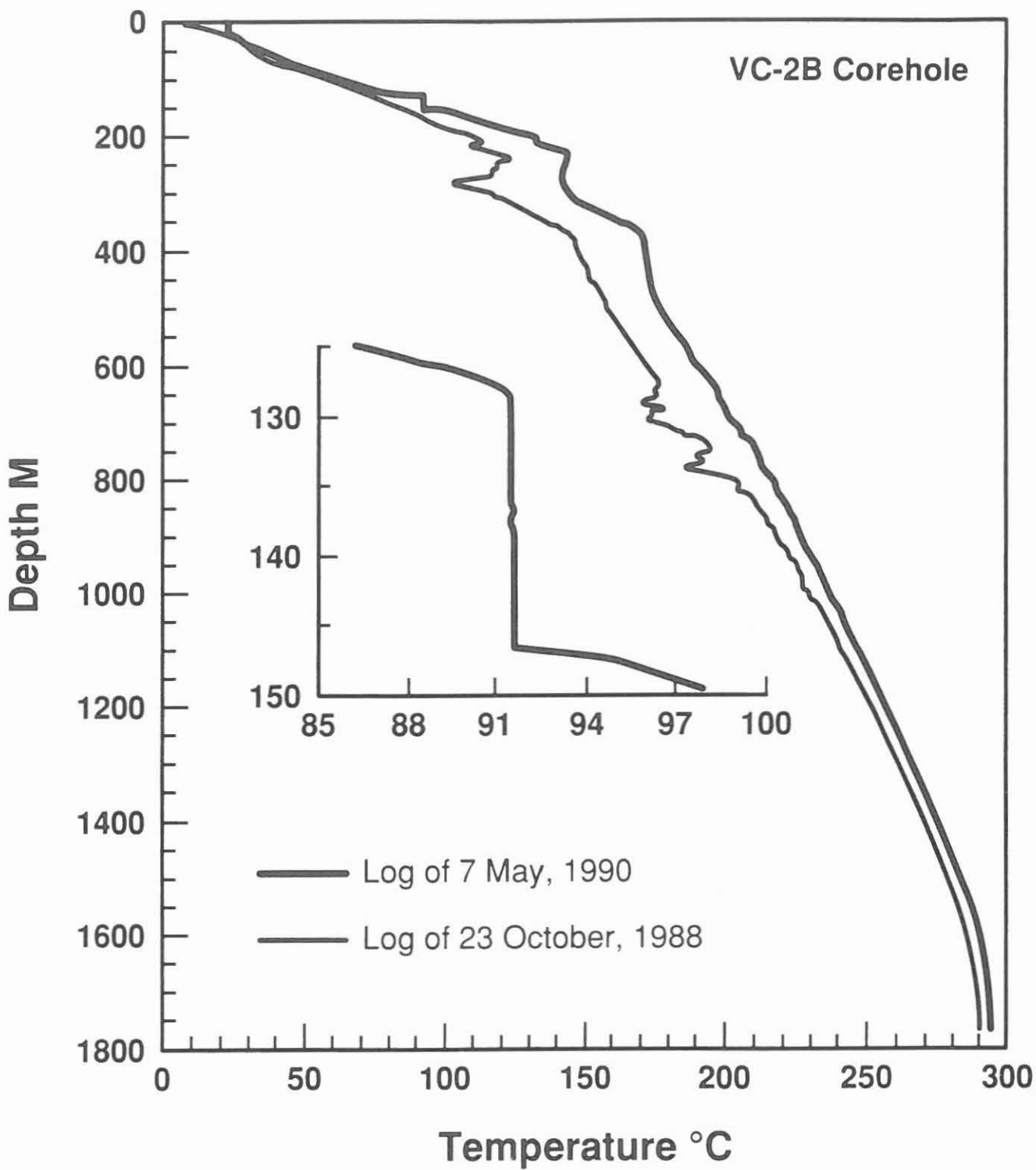

**Measurement systems for in situ data acquisition in
normal, superdeep, slim and tough boreholes**
Availability of tools from industry and third parties today

J. K. Draxler et al.

Geological Survey of Lower Saxony
KTB-Project Management
Stilleweg 2
30669 Hannover / Germany



**Measurement systems for in situ data acquisition in normal,
superdeep, slim and tough boreholes.
Availability of tools from industry and third parties today.**

J.K. Draxler, K. Bram
Geological Survey of Lower Saxony, KTB-Project
Hannover, Germany

Abstract

The oil industry was the leading factor in the development of in situ measurement systems. Developed for the hydrocarbon exploration in sediments, subsurface data acquisition has become the most valuable source of continuously recorded information. Measurement-While-Drilling (MWD), Logging-While-Drilling (LWD), Wireline Logging and Testing and Drill Stem Testing (DST) are the methods and tools applied today. The techniques have been refined, that practically all borehole conditions - horizontal, extended reach, slim, hot and superdeep - can be served.

Geoscientific research drilling projects can built on these experiences. The outstanding success of two of the presently active scientific programs, the Ocean Drilling Program (ODP) and the Deep Continental Drilling Program of Germany (KTB), speak for themselves. Excellent data has been recorded often under severe conditions by applying tough logging condition hardware. Integrating downhole measurements with information from other sources, scientists have formulated new concepts of the evolutionary processes on earth.

The development of downhole logging tools has progressed, - but the availability of high-temperature tools is lagging. Due to financial constraints within ODP and KTB development of these type of tools has either been delayed or cancelled. International cooperation is needed to fund the design and production of these special purpose tools.

Introduction

Downhole data acquisition has become an integral and well accepted method in exploring for hydrocarbons, ores and minerals. Scientific drilling programs, like the Deep Sea (DSDP) and later the Ocean Drilling Program (ODP) or the Deep Continental Drilling Program of Germany (KTB) gained from industry experiences.

Downhole measurements from logging and testing provide essential data for geologists and geophysicists complementing those obtained from core and cutting analysis. In addition, these in situ measurements guarantee data of well established physical definition, high vertical resolution and on a continuous basis.

Industry has developed in situ measurement methods according to commercial interests. Sediment lithology, hydrocarbon detection, porosity estimation and calculation of saturation were the prime goals for instrument development. With the search for hydro-thermal energy sources, radioactive waste disposal sites, mineral and ore prospecting commercial logging entered crystalline environment. Today a wide range of borehole conditions can be served. Sensors, which are lowered either on the drill string or on an electrical cable, measure physical parameters in situ downhole and these data are transmitted via the mud column or the cable to surface for real-time recording or are stored in memory downhole for later read-out. Affiliated companies to the oil industry offer their services and tools for recording the data.

Geoscientific goals and technical requirements

In contrast to the commercial interest when drilling for oil and gas, basic geoscientific research drilling requires a sophisticated system for downhole data acquisition appropriate to the specific scientific goals. Depending on the project adaptations are made to the systems to ensure maximum benefit. Taking the geoscientific research projects presently running, ODP and KTB as examples, goals and technical requirements can be postulated:

Geoscientific goals:

- Obtain subsurface information about age, structure, lithology, mineralogy, porosity and fluid content of the formation penetrated.
- Search for clues about the transport mechanism for fluids, heat flow and heat production.
- Establish the prevailing palaeo and present stress conditions to understand the tectonic history of an area and gain knowledge on earthquake mechanism.
- Use the information of potential field measurements to retrace continental and global changes.
- Study the sedimentation sequences and rates and relate them to climatic variations.
- Analyse mineral transformation to deduce subsidence and uplift.
- Correlate surface exploration data with downhole measurements.

Technical requirements:

- Find technical means at reasonable costs to provide the scientists with relevant high quality data, even under severe and extreme borehole conditions (superdeep, slim, horizontal and extended reach).
- Data acquisition in real-time with surface read-out and control has priority. Memory systems should be introduced, when link to surface is missing.
- Drill pipe or coiled tubing conveyed sensors, single or combination wireline logging tools should be deployed.
- Development of high-temperature and long time observation systems should be enhanced.
- Data should be recorded in one standard format for complete integration with data from other sources.

Measurement systems:

1. Measurements-While-Drilling (MWD)

Measurements-While-Drilling, typically refers to drilling parameters and directional information recorded downhole.

The data recorded are:

- Inclination and azimuth for borehole trajectory determination.
- Tool face orientation for steering operations.
- Real-time downhole torque (DTOR) and weight-on-bit (DWOB) measurements to control drilling progress.
- Resistivity (16" Normal) and Gamma Ray for geological Information.
- Data combinable with surface measurements to obtain qualitative and quantitative analysis of the drilling process.

These sensors are either built in special subs, adapters or drill collars. The normal temperature rating is 125 °C. Systems with higher temperature ratings are available.

For data transmission the mud pulse technique or the "mud siren" is used. High sampling rate data is stored in memory for read-out after pulling the drilling string. The sampling rate is preset as time interval.

During deployment coring is not possible. Systems are available from several service companies in sizes for operating in boreholes from 28" to 3 7/8" diameter.

Tool information are given in appendix: Table 1.

2. Logging-While-Drilling (LWD)

Logging-While-Drilling is the technology for making formation measurements with sensors built into special drill collars. Data is acquired directly after the formation has been drilled through. The sensors are located directly above the bit or at the shortest distance from it.

Sensors, which are comparable with wireline logging tools, are available for the following measurements:

- Short Normal Resistivity (16" Normal).
- Compensated Dual Resistivity Tool, makes deep and shallow resistivity logs.
- Standard Gamma Ray to measure natural gamma activity.
- Spectral Gamma Ray to record activity coming from potassium, thorium and uranium, total activity and computed gamma ray (without uranium part).
- Compensated Spectral Gamma-gamma Density and Photoelectric Effect (Pe).
- Epithermal Neutron
- Ultra-Sonic Caliper
- Standard Sonic is presently being introduced.

All these sensors are combinable with MWD tools in a single drilling string. Real-time logging means recording of telemetered data through the mud column or stored downhole. The data transmission rate is up to 12 bits per second or continuous, when the siren is used. The rate is given as preset regular time interval. Depth determination is made using the ratio of the time sampling interval and drill bit penetration.

The advantage of LWD-measurements is seen in a guarantee for data recovery, even if the well is lost or cannot be logged by wireline tools. For hydrocarbon exploration evaluation of saturation is enhanced as mud invasion is minimal. Lithology changes can be detected immediately and drilling operation halted for accurate placement of cores. Tools operate in vertical, normal deviated and in horizontal wells. The temperature rating of the tools is 150 °C for circulating fluid and 160 °C for static fluid conditions. The curvature of deviated holes must not exceed more than 4 1/2 degrees per 30 meters. Depending on the temperature rating the depth limitation is approximately 5 000 meters.

Several companies offer LWD-systems on rental basis

List of tools is given in appendix: Table 2.

3. Wireline Logging

Already 66 years ago the first resistivity log was recorded using an electrical cable for running the tool in the borehole and transmitting electrical signals to the surface. Since this time an outstanding evolution of wireline logging systems for the oil industry happened.

Nearly for all fields of measurable physical parameters tools are designed and operational to provide in situ information to the geologists and geophysicists. Resistivity, conductivity, self potential, acoustic, nuclear, magnetic, gravity and temperature measurements are available. In addition many other services like sidewall coring, formation testing, fluid sampling, perforating, production logging and free point measurements are run on wireline.

The tools operate on multi or single conductor cables. The rating of standard tools is: temperature 175 °C, and pressure 137.9 MPa. Hostile Environment Logging (HEL) requires a higher rating: temperature 260 °C and 172.4 MPa pressure. Tool diameters are adapted to the borehole conditions and range from 1 3/8" (35 mm) to 5" (127 mm).

The sampling rate for standard measurements is 6" (15.24 mm) or five times higher for better vertical resolution. The new scanning devices operate with a sampling rate at 0.1" or 2.5 mm. Digital cable transmission systems of today handle 500 kbits/second. The cable length may exceed 10 000 meter. For such length of cable special telemetry adjustment is required to reproduce readable signals.

The American Petroleum Institute (API) has recommended to apply the DLIS (Digital Log Information Standard) as the standard for digital log recordings.

Companies have specialized in providing world-wide round-the-clock service. As no other downhole measurement system can collect continuous data of such high quality the demand from industry is great. The scientific community planning geoscientific drilling projects is well advised to draw from the experience existing within the oil industry.

ODP and KTB are working in close cooperation with one of the major service companies. The results produced, the operational efficiency and the tool reliability are outstanding. Specific scientific questions called for tool developments outside the framework of service companies. These tools, known as "third party tools", have to be certified to satisfy the stringent operational and safety criteria set by KTB and ODP. The solutions found for ODP or the superdeep project KTB are unique in respect of heave compensation, cable configuration, cable winding system (capstan), logging unit installation and modification of tools for HEL conditions. A list of HEL - tools is given in appendix: Tables 3 and 4.

4. Wireline Testing (FT)

With wireline logging physical parameters under static conditions are recorded versus depth. During wireline testing operations temporary dynamic conditions are created and data are recorded versus time.

The main objective of formation testing is to produce fluid from the formation, record volume of flow versus time and to estimate permeability, measure pressures, analyse fluid properties downhole and recover fluid samples for surface analysis.

Testing tools are deployed on multi-conductor cables and are available in single or dual packer configuration with single or multiple sample chambers. Modern tools allow downhole fluid analysis and selection of "clean" samples by pumping contaminated fluids (invasion fluid) through the tool into the borehole. The operating range covers boreholes from 6" to 17 1/2". Presently the tool diameters are too large for running tests to a temperature of 175 °C in Germany as the hole diameter is <6" at this depth and temperature range. The pressure rating is 137.9 MPa. All major wireline service companies offer testing as routine service but with widely different tool capabilities.

5. Drill Stem Testing (DST)

If larger volumes of formation fluids are to be produced for estimation of flow potential drill stem testing will satisfy this request. Single or straddle packer arrangements are run on drill pipes and are used for zone isolation. Pressure gauges are mounted on strategic positions within the testing string. If fluids are produced to surface, the volume is measured by flowmeters. If not enough fluid enters the testing string to reach surface, reverse circulation will bring the sample to surface for analysis. In most of the operation water (mud) cushions are used to reduce the pressure differential to acceptable levels,

Packers are on the market for boreholes from 3 1/2" to 24". Here again the packer elements limit the operating range as these components of the testing tools are sensitive to elevated temperatures. For high temperature operations aluminium packers have been tested successfully.

6. Special devices for tough logging conditions (TLC)

a. Coiled tubing operation (Figure 1)

In highly deviated, horizontal or extended reach boreholes wireline logging tools need support to reach bottom. For pushing these tools to the intervals to be logged, coiled tubings are used.

The logging tools are rigidly fixed at the end of the coiled tubing and electrically connected to the standard logging cable, which is permanently installed inside the tubing. By pulling the coiled tubing the logs are recorded like standard wireline operations. The only difference being, that the depth reference has to be taken from the tubing and not from the cable motion.

Maximum depth for this type of operation is about 5 000 meters. This is the limitation of coiled tubing deployment. Single or combination logging tools can be assembled, like for standard wireline operations.

b. SINPHOR or TLC operation (Figure 2)

Under certain difficult borehole conditions logging jobs can only be conducted when the logging tools are conveyed by drill pipes into the hole. Two systems exist for connecting the logging tools to the drill pipes. The tools are either mounted directly or are placed inside a protective sleeve at the end of the drill pipes. The assembly is run into the borehole until the depth of the top of the interval to be logged. The wireline logging cable with the wet-connector is fed into the drill pipes and pumped down to establish contact with the logging tool. Through the side-entry-sub the cable is guided to the outside of the drill string. Stands of drill pipes are added until the logging tool reaches bottom. To protect the logging tool, a hydrostatic shock absorbing sub is run on bottom of the tool in combination with a compression/tension sub on top of the logging tool for monitoring drill pipe weight on the logging instrument. As additional devices a swivel and a tool turner will position pad tools to the low side of the well.

Logging operations can start by pulling stands of drill pipes and spooling-in the logging cable simultaneously until the side-entry-sub reaches surface again.

This is a very time consuming operation but often the only safe way to run logs under severe conditions. Circulation during logging for cleaning and cooling the hole is possible. Wet-connector assemblies are rated 175 °C and 137.9 MPa.

c. Slim Holes

The mining industry has specialized in drilling small diameter boreholes. The oil industry has recognized the advantages, predominantly cost savings, using this technique. In addition, the reliability of good core recovery made slim hole drilling the favourite drilling technology of the geologists. The hole diameter is never larger than 5". Logging with standard oil field tools is restricted as these tools have outside diameters between 3 5/8" and 5". Special slim hole logging tools are required. The diameter of these tools range from 1 3/8" to 2 3/4". The temperature and

pressure rating can be lower than for oil field tools as the maximum depth for slim hole wells is about 5 000 meters. List of slim hole tools is given in appendix: Table 5.

d. Hot holes

The exploration for geothermal energy shifted drilling and logging technology to hot terrain. Wells with bottom hole temperatures of 375 °C have been drilled.

In these wells only temperature logs and pressures could be recorded. No logging tools for formation evaluation, like resistivity or porosity tools, exist. Hostile Environment Logging (HEL) tools and associated equipment have temperature ratings of 260 °C and pressure rating of 172.4 MPa only.

The superdeep well Kola SG-3 recorded a temperature of 203 °C at 12 000 meters. In the KTB well a temperature of 229 °C was logged at 8 100 m on the last logging operation, confirming the prediction of about 300 °C formation temperature at 10 000 meters. To log this well from final depth, precooling by extended circulation will be necessary. Even than, successful data acquisition can not be granted.

Future superdeep drilling projects and/or projects in hot environment depend on the development of high-temperature tools. Every effort should be made to join talents, ideas and funds on an international basis to realize such developments.

The cancellation of 300 degree tool development by KTB and the delay of funds within ODP must be taken seriously. The way to ameliorate the situation can only be: international cooperation between industry and scientific institutions.

Recommended infrastructure

The logging program for geoscientific research boreholes follows different goals than an evaluation for a commercial well. A full logging suite will only be run over the reservoir interval in the commercial well, with a simple correlation log over the remaining section.

For scientific studies the total drilled section of a research well is logged with all available sensors to obtain the maximum of information for the evaluation. The data will certainly contribute to the success of the project. This operation requires an infrastructure different from industry set-ups.

Industry operates on a "first call - first serve" basis. This means, personnel, logging unit and tools will be moved to the location on call. Service companies have specialized in this type of operation. The company giving the order is contracting the complete logging activity.

Depending on the goals, duration and depth of a scientific drilling project contracts with the service company will have to be made either for industry-type service (shallow wells) or for a long time arrangement for deep wells. Taking again ODP and KTB as examples, careful studies revealed, that the most economic set-up calls for a permanently installed logging unit and a set of often used tools stationed on location (Figure 3). A dedicated crew will guarantee high performance and lost-time-free operation. The basic equipment could be leased or purchased. Additional tools for logging series will be brought-in on request.

Between 7 and 13 % of the total costs of an hydrocarbon exploration well industry assigns for downhole data acquisition, including coring, logging and testing .

Considering the importance of subsurface information for a geoscientific project, the same amount of funds should be allocated for logging and testing, - excluding the costs for coring and R & D.

Conclusions

Downhole measurements for geoscientific research drilling projects require strong industry support.

For shallow (<3 000 m) or medium (<5 000 m) depth projects industry-type contracts could provide adequate and economic service.

Ambitious deep or superdeep projects (>5 000 - 10 000 m) encounter hostile environment need very careful economic studies well in advance of spudding date.

Logging tools and associated equipment is available to handle even severe borehole conditions.

Development of high temperature tools should be initiated on an international basis as costs might surpass national allotments for R & D.

For the logging and testing program of a scientific research well a sufficient percentage of the budget should be designated.

For a drilling project lasting several years, a permanent logging centre equipped with a number of frequently used tools on location and operated by a dedicated crew will guarantee efficient and economic operation.

Well in advance decision will have to be made which system for downhole data acquisition should be deployed, wireline or LWD.

The data must be recorded in a standard format combinable with information from other sources.

Downhole logging information complement data from cutting and core analysis and provide real-time results for technical decisions.

References

- Anderson, Roger N.; Jarrad, Richard; Pezard, Philippe; Williams, Colin; Lamont-Doherty Geological Observatory, Palisades, NY; Dove, Roy; Schlumberger Well Services, Houston Tx; Logging for Science Technical Review, Vol. 36, No. 4, October 1988
Schlumberger Educational Services
Ridgefield, CT 06877-4108, USA
- Anadrill / Schlumberger; MWD Formation Logging Services (FLS)
Anadrill / Schlumberger
Sugar Land, Tx, 1988
- BPB Instruments; Wireline Logging Services
BPB Instruments LTD, Loughborough, England, 1990
- Bram, K; Draxler, J.K.; KTB-Report 93 - 1, Basic Research and Borehole Geophysics (Report 14)
Borehole logging in the KTB-Oberpfalz HB, - Interval 4 512.0 - 6 018.0 m -
Niedersächsisches Landesamt für Bodenforschung, Hannover 1993
- Cantrel, LeAnne; Paxson, Kevin B.; Keyser, William L.; Texaco E & P, Inc.; Ball, Scott; Sperry-Sun Drilling Services, Inc.; A Proven record is changing attitudes about MWD logs
World Oil, July 1993, pages 55 - 62.
- Halliburton Logging Services; Heat Suite / Slim Hole Logging
Halliburton Logging Services, Houston, Tx, June 1991
- Hull, Gordon T.; Growth in the Measurement-While-Drilling Sector continues
First Boston Corp. New York, Oil and Gas Journal, Sept. 1991

Institut Français du Petrol; SIMPHOR, Drill Pipe Assisted Well Logging System
HORSEIS, System for Seismic Data Acquisition and Processing in Horizontal Wells
IFP Industrial Division, Exploration & Production, Rueil Malmaison, France, 1992

Oil & Gas Journal; Technology; MWD tools open window at bit
Oil & Gas Journal, May 24 1993, pages 86 - 87.

Schlumberger; TLC Tough Logging Condition System
Schlumberger Well Services, Houston Tx, 1988

Schlumberger; Wireline Services Catalog
Schlumberger Educational Services, Houston Tx, November 1991

Western Atlas International; Atlas Wireline Services, Services Catalog
Western Atlas International, Houston Tx, 1985

Worthington, Paul; Fisher, Andy; Golovchenko, Xenia; Downhole Measurements in the Ocean
Drilling Program, A Scientific Legacy;
Ocean Drilling Program, Texas A&M University, College Station, TX 77845, USA
(ODP/8/92/4M/1.0)

List of Addresses (Third Party Tools)

BGR
Bundesanstalt für Geowissenschaften
und Rohstoffe, Abt. B 3.13
Stilleweg 2
D-30655 Hannover / Germany

CGG
Compagnie Général de Géophysique
1 Rue Léon Migaux
F-91341 Massy Cedex / France

EDCON
Edcon, Inc.
171 South Van Gordon Street
Denver, Colorado 80228 / USA

ENEL
Ente Nazionale per L'Energia Elettrica
National Geothermal Unit
14 Piazza Bartolo da Sassoferrato
I-56100 Pisa / Italy

UNI-Frankf.
Johann Wolfgang Goethe Universität Frankfurt
Institut für Meteorologie und Geophysik
Feldbergstraße 47
D-60323 Frankfurt am Main / Germany

BPB
BPB Instruments Ltd.
East Leake
Loughborough, LE12 6JQ
England

DMT
Deutsche Montan Technologie
für Rohstoff-Energie-Umwelt
Westhoffstraße 17
D-44791 Bochum / Germany

ELGI
Eötvös Loránd Geophysical Institute
XIV. Columbus útca 17-23
H-1440 Budapest / Hungary

GSC
Geophysical Surveying Co. Ltd.
3-6-3 Nihonbashi Hamacho, Chuoku
Tokyo 103 / Japan

LANL
Los Alamos National Laboratory
Los Alamos, New Mexico 87545 / USA

LDEO
Lamont-Doherty Earth Observatory
Borehole Research Group
Columbia University
Palisades N.Y. 10964 / USA

Sc.Drill.Con.
Scientific Drilling Controls Ltd.
Wellhead Industrial Estate
Complex B.10/11
Dyce, Aberdeen AB2 0Ga / Scotland

TU-Braunsch.
Technische Universität Braunschweig
Institut für Geophysik und Meteorologie
Mendelsohnstraße 3
D-38106 Braunschweig / Germany

NLfB
Niedersächsisches Landesamt für
Bodenforschung Ref.: N1.14
Stilleweg 2
D-30655 Hannover / Germany

SZKFI
Hungarian Hydrocarbon Institute
P.O.Box 32
H-2443 Százhalombatta / Hungary

Appendix

Table 1: MWD Tools
Table 2: LWD Tools
Table 3: HEL Tools
Table 4: HEL Tools (special)
Table 5: Slim Hole Tools

Figure 1: Coiled Tubing Operation
Figure 2: SIMPHOR Operation
Figure 3: Infrastructure KTB

Measurement-While-Drilling (MWD)

Table 1

Measurement	Anadrill	Geodata	Sperry-Sun	Smith Int.	Baker Hughes
Sizes	6 1/2" - 9 1/2"	6 1/4" - 8"	4 3/4" - 9 1/2"	6 1/2" - 9 1/2"	3 7/8" - 9 1/2"
Weight on Bit	x	x	x		x
Torque on Bit	x	x	x		x
Azimuth	x	x	x	x	x
Inclination	x	x	x	x	x
Tool Face Ori.	x	x	x	x	x
Resistiv. 16"	x	x	x	x	x
Gamma Ray	x	x	x		x
Temp.(int.)	x				x
Temp. (ann.)	x				
Flow Rate	x				
BH Pressure	x	x	x		x
Vertic.Drill.					x
Resist.at Bit	x				
Inclinat.at Bit	x				
Memory Syst.	x				x

Logging-While-Drilling (LWD)
(or Formation Evaluation MWD)

Table 2

Measurement	Anadrill	Geodata	Sperry-Sun	Smith Int.	Baker Hughes
Sizes	6 1/2" - 9 1/2"	4 3/4" - 9 1/2"	4 3/4" - 9 1/2"	6 1/2" - 9 1/2"	6 1/2" - 9 1/2"
Resistiv.(lat)	x	x			
Resist. at Bit	x				
Dual Com.Res.	x				
Elect.mag.Res.	x		x		x
Resistiv. 16"	x	x	x	x	x
Gamma Ray	x	x	x	x	x
Comp.Density	x	x	x		x
Photoel.Effect	x				x
Comp.Neutron	x	x	x		x
Sonic Caliper	x	x			
Sonic	to be introduced				
Memory Syst.	x	x	x	x	x

Hostile Environment Logging Tools (HEL-Tools) Table 3

Ratings: Temperature 260°C, Pressure 172.4 MPa (Halliburton,Schlumberger)
 232°C, Pressure 172.4 MPa (Western Atlas - Ultra Hostile Environ.)

Tool	Halliburton Tool Diameter	Schlumberger Tool Diameter	Western Atlas Tool Diameter	West. Atl.Geo. Tool Diameter 260°C,103 MP	SZKFI Hungary Tool Diameter
Resistivity		DLT-C 4 1/2"			LL-7 3 1/2"
Conductivity	HDIL 2 3/4"	IRT-M 3 5/8"	IEL 3 3/8"		
Litho-Density	HSDL 2 3/4" / 3 1/2"	HLDT-BA 3 1/2"			
Comp.Form. Density		FGT-CA 2 3/4"	CDL 3"	CDL 3" / 4 3/8"	
Compensated Neutron	HDSN 2 3/4"	CNT-DA 2 3/4"	CNL 2 3/4"	NEU 2 3/4"	
Gamma Ray	HGR 2 3/4"	ATE-C 3 5/8"	GR 2 3/4"	GR 2 3/4"	
Gamma Ray Spectrometer		HNGT (1) 3 5/8"	SPL 3 5/8"		
Boreh. Comp. Sonic		SLT-SA 2 3/4"	AC 2 3/4" / 3 1/2"		BHC 3 1/2"
Full Wave Sonic	HFWS 2 3/4"				
Four-Arm Caliper	HFAC 2 3/4"				
Caliper		EDC 2 3/4"	CAL 2 3/4"	CAL 2 3/4"	
Powered Decentraliz.	HPDC 2 3/4"				
Formation MicroScanner		FMS (2) 5"			
Temperature	TEMP 2 3/4"			TEMP 1 11/16"	
Stuck Point Indicator		SIT (2) 1 11/16"	Spring Tect. 1 3/8"		
Fluid Sampler	FS 2"				
Auxiliary Measur.Sonde		HAMS (2) 3 5/8"			

(1) MAXIS 500 tool

(2) for KTB only

Hostile Environment Logging Tools (HEL-Tools)

Table 4

(Special Tools - Third Party Tools)

Ratings: Temperature 260°C and higher (*), Pressure 103.4 - 172.4 MPa

Tool	EDCON Tool Diameter	CGG/SSL Tool Diameter	DMT Tool Diameter	GECO-Prakla Tool Diameter	Sc.Drill.Com. Tool Diameter
Geophone		Geophone		BGKT 3 3/4"	
Gravity Meter	HBGM 5 1/4"				
Borehole Televiewer			Facsimile 3 3/16"		
Gyroscope					EYE / Finder 1 3/4" / 3 1/8"

Tool	UNI-Frankf. Tool Diameter	NLFB Tool Diameter	LDEO Tool Diameter	LANL Tool Diameter	ENEL Tool Diameter
Temperature		TEMP* 1 3/8"	TEMP 2 1/4"	TEMP* 2 3/8"	TEMP/ PRES* 1 7/8" - 3 3/8"
Redox Potential	REDOX 3 5/8"				
Borehole Televiewer				BHTV 3 3/8"	
Fluid Sampler				FS 5"	FS 4 1/2"

Tool	GSC Tool Diameter	Sc.Drill.Con. Tool Diameter	BGR Tool Diameter	TU-Braunsch. Tool Diameter	ELGI Tool Diameter
Temperature	TEMP* 2 1/8"				
Magnetometer			Fluxgate* 3 1/2"	FML* 3 5/8"	
Induced Polarisation					IP* 3 1/2"
Steering Tool		STT* 2 1/8"			

Slim Hole Logging Tools

Table 5

Ratings: Temperature 175°C , Pressure 137.9MPa (Halliburton,Schlumberger,Western Atlas, DMT)

Temperature 70°C or higher, Pressure 20 MPa or higher (BPB)

Tool	Halliburton Tool Diameter	Schlumberger Tool Diameter	Western Atlas Tool Diameter	BPB Tool Diameter	DMT Tool Diameter
Resistivity		DL 2 3/4"		RO1 1 1/2"	
Conductivity	HDIL 2 3/4"	IRT-J 2 3/4"	IEL 2" / 2 3/4"		
Litho-Density	HSDL 2 3/4"				
Comp.Form. Density		FGT-CA 2 3/4"		DD1 1 7/8"	
Compensated Neutron	HDSN 2 3/4"	CNT-DA 2 3/4"	CNL 2 3/4"		
Gamma Ray Neutron	GRN 1 11/16"	GNT 1 11/16"	NEU 1 11/16"	NN1 1 1/2"	
Thermal Neutron	TMD 1 11/16"	TDT-P 1 11/16"	PDK-100 1 11/16"		
Boreh. Comp. Sonic		SLT-SA / JF 2 3/4" / 1 11/16"	AC 2 3/4"	MS1 2 1/2"	
Full Wave Sonic	HFWS 2 3/4"				
Four-Arm Caliper	HFAC 2 3/4"				
Caliper		EDC 2 3/4"	CAL 2 3/4"	CO1 1 1/2"	
Borehole Televiwer		SBTT 1 11/16"			Facsimile 2 3/8"
Formation MicroScanner		FMS-B 3 5/8"			
Temperature	TEMP 2 3/4"	HRT 1 11/16"	TEMP 1 11/16"		
Free Point Indicator		FPIT 1 3/8"	Spring Tect. 1 3/8"		
Production Logging Tool	PLS 1 11/16"	PLT 1 11/16"	SPL 1 11/16"		
Reservoir Saturation T.		RST-A / B 1 11/16" - 2 1/2"			
Fluid Sampler	FS 1 11/16"	PFS 1 11/16"	FS 1 11/16"		
Dipmeter				DV1 / DV2 2" / 2 1/2"	
Verticality Sonde				VO1 / VO2 1 11/16"	
Seismic Reference				SR1 2 3/8"	

Figure 2

Coiled Tubing Supported Logging Operation

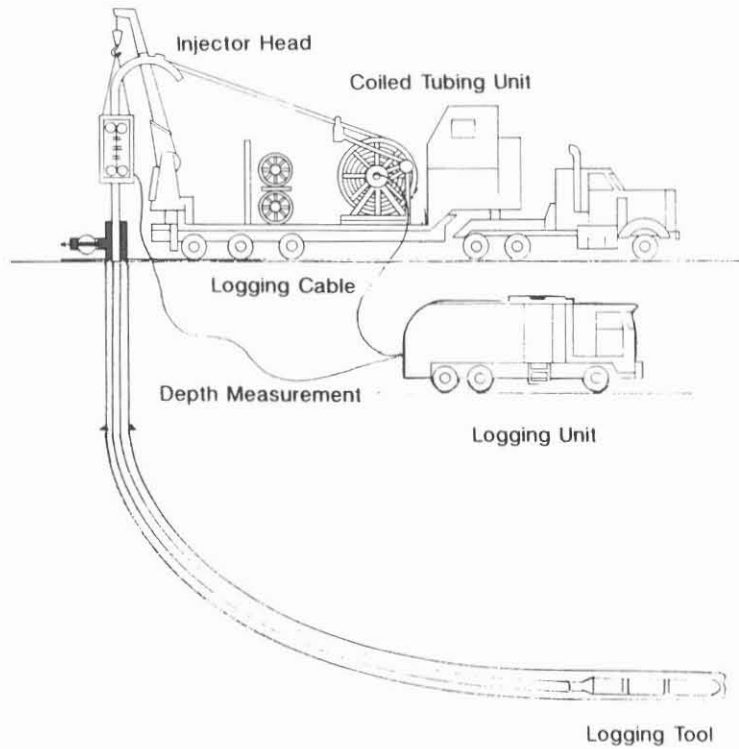

Coiled Tubing Operation

Dx-8/93

KTBB

Niedersächsisches Landesamt für Bodenforschung

Figure 1

SIMPHOR[★] Operation

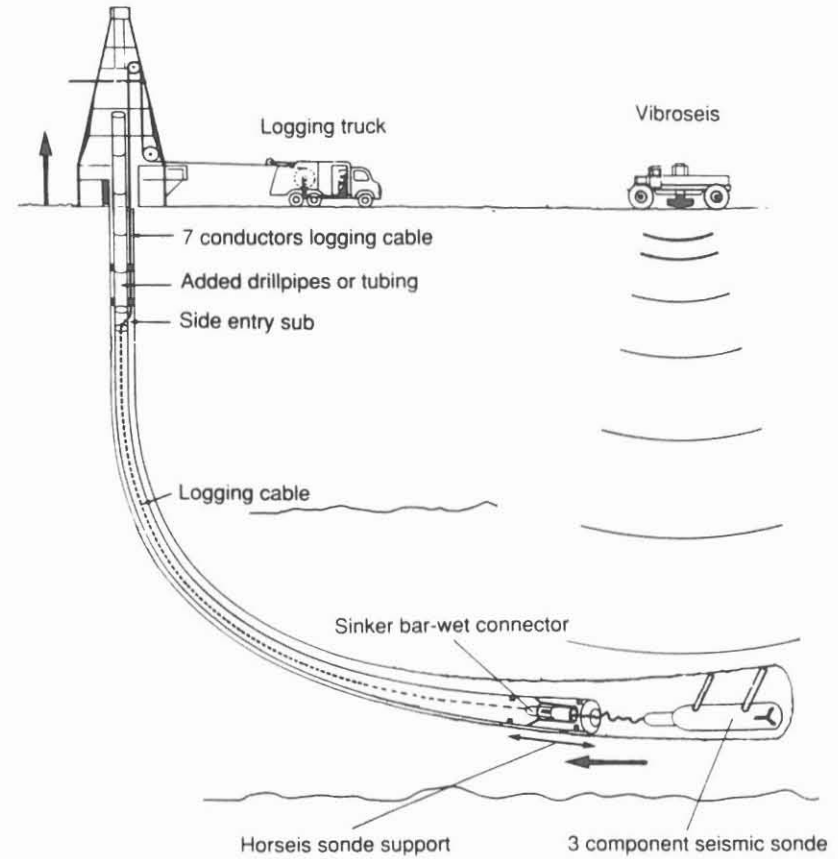

★ IFP

TOUGH LOGGING CONDITION SYSTEM

Dx-8/93

KTBB

Niedersächsisches Landesamt für Bodenforschung

Figure 3

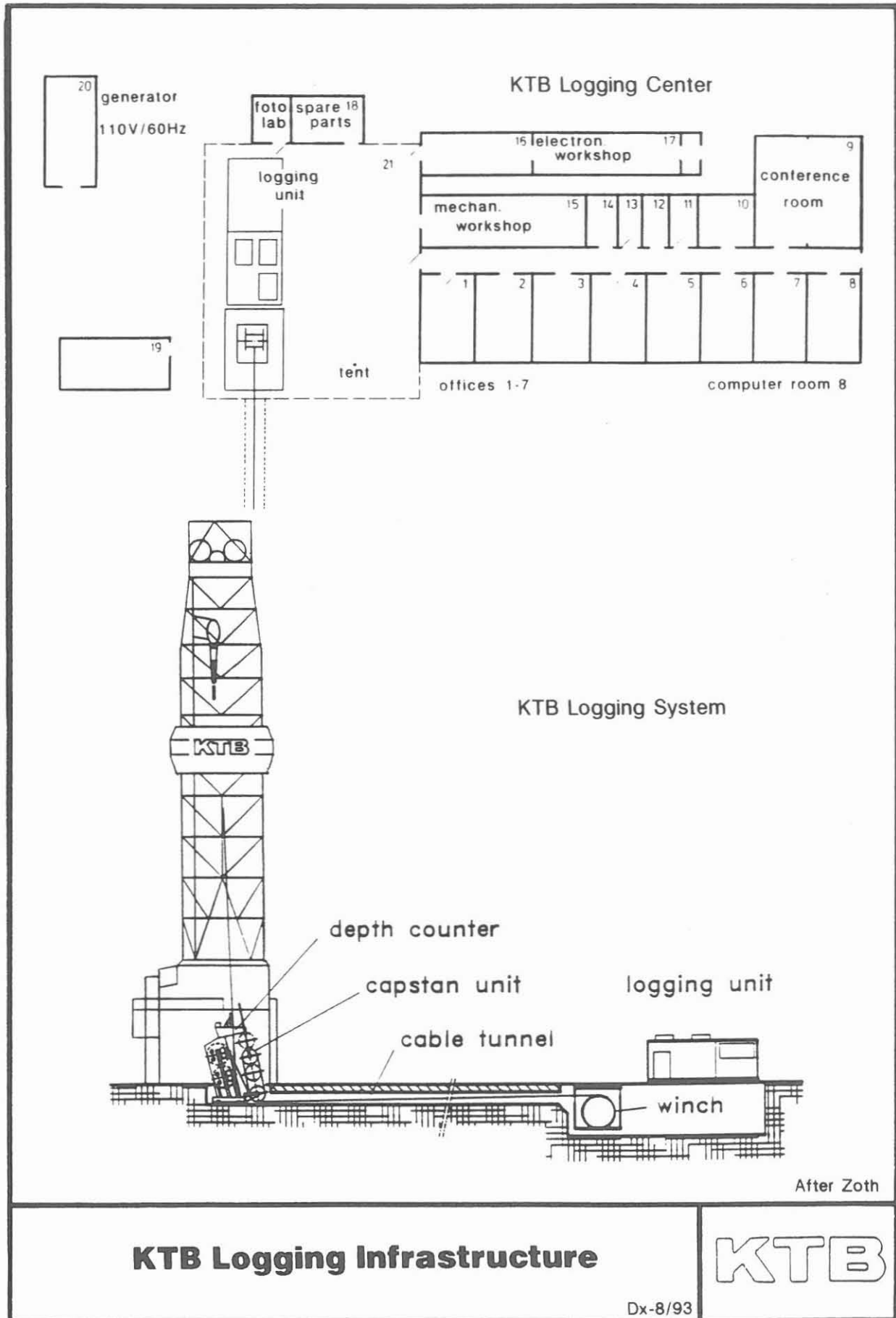

ISSN 0939-8732
ISBN 3-928559-14-1